



AQUABRASS



AQUABRASS

TAMING THE BEAUTY OF WATER

aquabrace.com

WELCOME TO AQUABRASS



Behind our products, there are masterminds in design, craftsmanship, quality and trends. I dedicate this edition to our passionate people. The AB family.”

Antonio Masecchia, CEO

Aquab Brass, Urban Faucet Maker.

Born in Montreal and inspired by the city’s European flair and North American practicality, the Aquab Brass brand has gained the worldwide acclaim of designers and architects.

For over thirty years, our continued search for excellence in the field of high quality bathroom and kitchen faucets, shower fixtures and accessories has led to the creation of products that respond to our clients' quest for unique designs and finest materials.

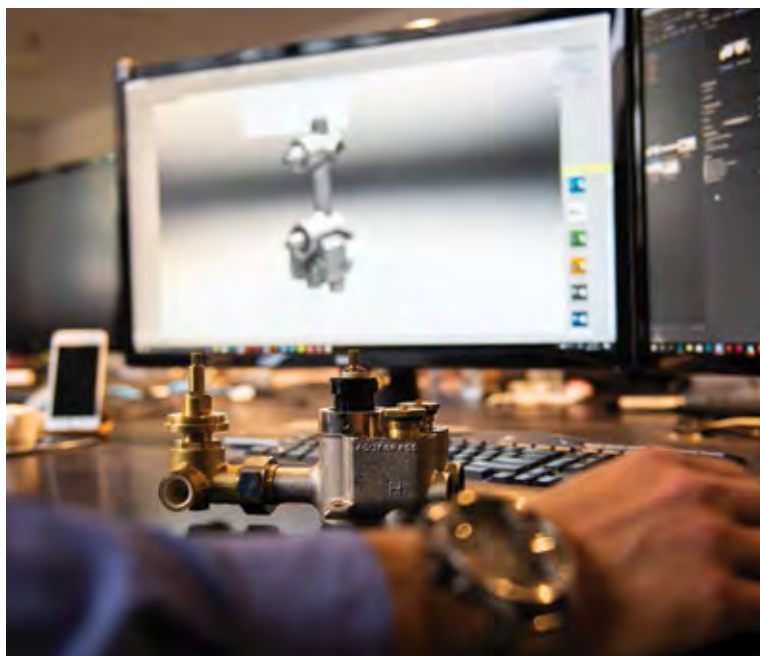

Designed in-house, our TURBO thermostatic valve series is a judicious composition of the best-performing components available on the market and R&D expertise. Discover TURBO on page 241.



Our Montreal warehouse is equipped with automated vertical storage units, improving picking process and speed, as well as optimizing inventory space.



We take pride in utilizing high-tech manufacturing processes.

THE AQUABRASS TEAM: ONE COMMON OBJECTIVE

Our team is multidisciplinary and our work environment is collaborative. We have created a space where ideas flow freely and the designers are never too far from the technicians in order to ensure that the beauty of our products is equalled by their functionality and durability.



R&D team members finalizing the details of the MB2 collection. Discover MB2 on page 60.

Montreal communal office table, encouraging communication amongst staff and reinforcing the Aquabross team spirit.



CRAFTSMANSHIP: THE HUMAN TOUCH

Each part of every product is handled by expert artisans dedicated to producing an unequalled level of excellence at each step of the production process. Our production and assembly facilities have been optimized to allow those skilled hands to perform at their best.



Meticulous faucet assembly process.

Hand picking of a brushed gold plated rainhead.



Electroplating process.



FINISHES

The collection of Aquabraxs finishes proposes a number of sleek, stylish shades, carefully selected to offer you an array of options to fit with your bathroom and kitchen designs. From gold to copper, black to nickel and bronzes, there truly is a finish for every esthetic.



IN STOCK FINISH SELECTION



Polished Chrome (PC)
unlacquered
lifetime warranty



Brushed Nickel (BN)
lacquered
3 year warranty



Brushed Gold (BGD)
lacquered
3 year warranty



Electro Black (EBK)
lacquered
lifetime warranty



Brushed Nickel PVD (BNVD)
lifetime warranty



Brushed Gold PVD (BGVD)
lifetime warranty



Black (BK)
powder coat
3 year warranty



Polished Stainless Steel (PSS)
lifetime warranty



Brushed Stainless Steel (BSS)
lifetime warranty

CUSTOM FINISH SELECTION



Products featuring this icon are available in custom finishes, with a **10 weeks delivery lead-time**.
The warranty for custom finishes is three (3) years.



Gold - 500
unlacquered



Brushed Gold - 515
lacquered



British Gold - 535
mat lacquered



Rose Gold - 520
lacquered



Antique Brass - 435
lacquered



Montreal Black - 375
mat lacquered



Black Nickel - 270
unlacquered



Tuscan Bronze - 365
lacquered



Graphite - 255
mat lacquered



Brushed Chrome - 110
unlacquered



Brushed Nickel - 215
lacquered



Polished Nickel - 200
unlacquered



Antique Copper - 335
lacquered



Antique Copper Dark - 345
lacquered

OUR COMMITMENT TO THE ENVIRONMENT

Our Montreal based state-of-the-art plating facility is the perfect blend of technology, artistic craftsmanship and a devoted commitment to the environment that exceeds North American ecological standards.

Our facility includes a government approved water treatment system that removes impurities and limits the amount of dissolved metals present in our wastewater. Impurities are transported by water and sent to our in-house water treatment system for their removal.

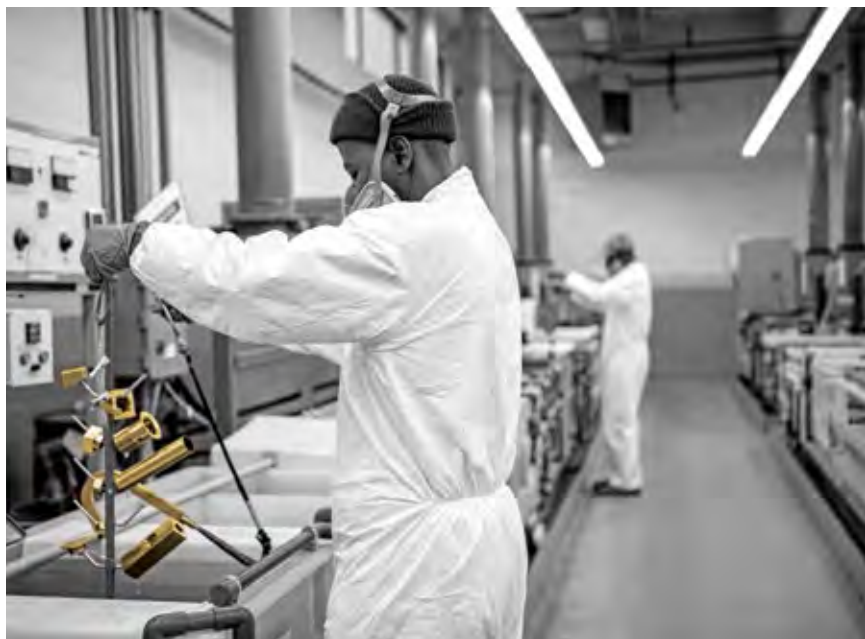

PROTECTING IS CARING

Aquabass products are carefully hand brushed/polished, followed by a custom electroplating finishing procedure.

As some metals, such as nickel, copper and brass, have a natural tendency to tarnish at ambient conditions, a high quality clear coat (lacquer) is applied on brushed surfaces to provide extra protection. Polished finishes such as Gold, Nickel Silver and Black Nickel maintain their properties over time if properly cared for, and therefore do not require any protective coat.

Custom plated fixtures are artisanal products that must be maintained and carefully cleaned on a regular basis to preserve their beauty. See page xix for the care and maintenance of finishes.



ICONOGRAPHY

BATHROOM FAUCETS TABS BAR



Timeless design collections

p. 2-59



Round shaped collections

p. 60-115



Squircle shaped collections

p. 116-171



Square shaped collections

p. 172-207

WATER FLOWS

A series of icons have been created to better illustrate the choice of water flows our products have to offer, whether it be for shower components or kitchen faucets.

SHOWER COMPONENTS p.239-283

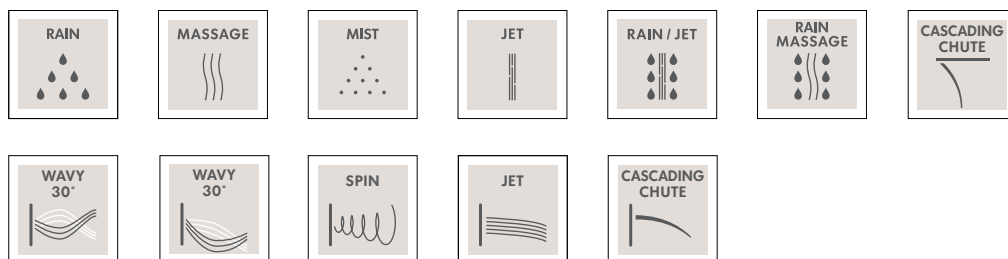

WELLNESS PRODUCTS (CURA RAINHEADS) p.286-292

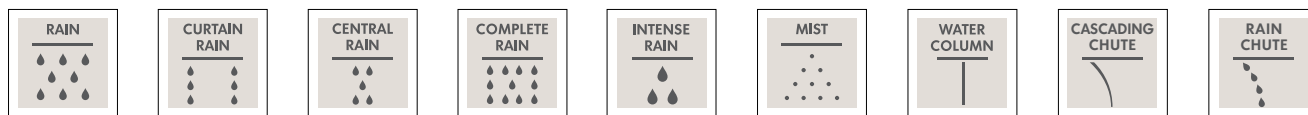

KITCHEN FAUCETS p.317-338

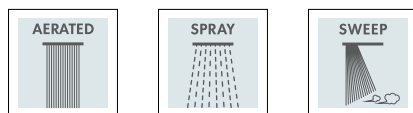

PARTS



Ceramic cartridge



Side valve ceramic cartridge – Cold & Hot



Diverter cartridge



Thermostatic cartridge



Shut-off ceramic valve cartridge



Check stop Hot



Check stop Cold



Extension kit



INTENSE
RAIN

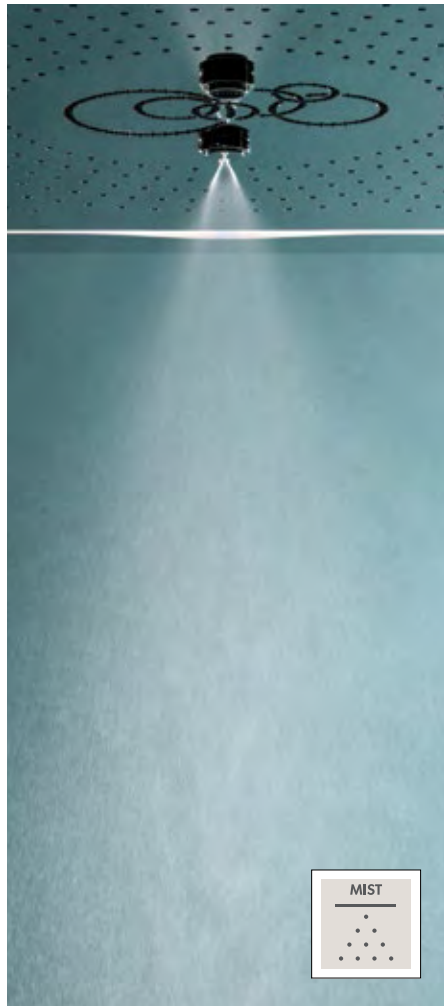

MIST



WATER
COLUMN



AERATED



RAIN



INDEX

CODE	PAGE	CODE	PAGE	CODE	PAGE	CODE	PAGE
126	277	712	256	1438	272	2581	281
130	29	801	264	1503	308	2582	281
	41	802	264	1504	308	2583	279
131	29	803	265	1507	308	2872	263
	41	807	266	1508	308	3145N	322
134	335	808	258	1510	308	3345N	325
135	277	810	258	1511	308	3503	309
136	277	811	258	2001	302	3507	309
140	335	815	265	2004	303	3508	309
172	277	820	266	2007	302	3511	309
403	315	916	287	2021	302	3745N	331
405	315	917	288	2037	303	3845N	330
406	315	922	290	2040	303	4103	310
407	315	925	291	2054	303	4104	310
408	315	928	292	2065	304	4107	310
409	315	945	289	2067	304	4108	310
411	315	952	288	2068	304	4111	310
465	262	957	287	2072	302	4501	311
567	262	958	289	2150S	334	4502	311
626	212	960	290	2454	213	4503	311
627	212	1206	249	2464	213	4507	311
628	212	1401	271	2508	260	4508	311
629	213	1404	271	2510	260	4510	311
637	212	1408	271	2512	260	4511	311
638	213	1409	271	2565	280	4681S	333
698	212	1417	272	2566	280	4703	312
699	212	1421	272	2574	279	4707	312
708	256	1425	272	2575	279	4708	312
710	256	1436	272	2576	279	4711	312

CODE	PAGE	CODE	PAGE	CODE	PAGE	CODE	PAGE
5043N	328	12032	282	19020	166	34004	19
6045J.	327	12685	268	19032	167	34014	18
6103	313	12686	276		282	34016	18
6107	313	12695	269	19074	166	34029	18
6108	313	12696	276	19085	167	34114	18
6111	313	12716	270	19495.	252	34124	19
6545B	320	12753	276	19N29	166	34514	20
6545N	319	12762	270	20343	332	34516	20
6745N	321	12763	276	27412	79	34529	20
6845N	318	12784	268	27414	78	34829	18
7145N	323	12794	269	27416	78	35829	20
7304	40	15014	118	27420	78	37373	255
7316	40	15016	118	27424	79	39514	54
7318	40	15018	119	27426	79	39516	54
7326	41	15019	118	27N29	78	39518	55
7386	41	15084	118	27N84	79	39520	54
8045N	324	17013	159	28014	210	39526	55
8603	314	17014	158	30045	329	39529	54
8607	314	17020	158	32004	143	39544	54
8608	314	17074	158	32013	143	40138	335
8611	314	17173	255	32014	142	40208	335
10232	283	17714	211	32015	142	40218	335
10332	283	17N29	158	32020	142	40255	253
11132	282	17N85	159	32044	142	42300	213
11632	283	18014	110	32074	143	42355	253
11732	282	18016	110	32085	144	45014	210
11812	283	18018	110	32095	252	51014	86
11932	282	18020	110	32N29	143	51020	86
12014	210	19014	166	33045	326	51595	252

INDEX

CODE	PAGE	CODE	PAGE	CODE	PAGE	CODE	PAGE
51904	94	61029	102	77N29	202	85174.	275
51914	94	61044	102	78373	255	85265	274
51990	94	61085	103	78473	252	85275	275
51N04	87	61095	252	80914	211	85279	274
51N29	86	61614	46	81514	210	85285	275
51N85	87	61616	46	83029	36	86013	184
52635	238	61620	46		40	86014	184
52N35	236	616N85	46		134	86020	184
53004	29	61714	47	83229	78	86N85	184
53006	28	61716	47	83516	36	91821	31
53014.	28	61720	47	83518	36	92014	150
53026	30	617N85	47	83526	36	92017	151
53086	29	61934	248	83529	36	92020	150
53095	252	61934	254	84014	176	92024	152
53N10	28	61N84	103	84016	176	92032	152
53N16	28	62335	237	84018	176		282
53N29	28	67746	281	84020	176	92064	150
54014	211	68012	135	84026	177	92189	46
56014	126	68014.	134	84084	177		47
56020	126	68016	134	84473	252		70
56032	127	68020	134	84514	174		71
56074	126	68024	135	84516	174		87
56084	126	68026	135	84518	174		151
61013	103	68029	134	84520	174		194
61014	102	68N84	135	84526	175		195
61020	102	77313.	202	84584	175	92N04	151
61024	104	77314.	202	85154	275	92N29	150
61026	104	77320	202	85162.	274	92N85	151
61028	102	77346	281	85164	274	93221	254
						93222	254
						93223	254
						93231	254

CODE	PAGE	CODE	PAGE	CODE	PAGE	CODE	PAGE
93232	254	B9706	307	CL20BC	4	M8206	259
93233	254	B9707	307	CL20NM	10	M8301	257 261
93421	254	B9708	307	CL24BC	6	M8302	259
93422	254	B9710	307	CL24NM	12	M8303	259
93423	254	B9711	307	CL28BC	5	M8401	257 261
93431	254	C8273	42	CL28NM	11	M8402	259
93432	254	C8283	37	CL29BC	4	MB095	67
93433	254	C8373	42	CL29NM	10	MB210	62
93821	248	C8383	37	CL32BC	6	MB214	62
93822	248	C9273	42	CL32NM	12	MB220	62
93823	248	C9283	37	CL85BC	6	MB224	63
93831	248	C9373	42	CL85NM	12	MB229	62
93832	248	C9383	37	CL95BC	252	MB284	63
93833	248	CB029	62 143 158 166 202	CL95NM	252	N3645	273
93921	248			INABOX-01	296	N3745	273
93922	248			INABOX-01G	296	N7329	40
93923	248	CB304	19 87 151	INABOX-02	297	R0695	249
93931	248			INABOX-02G	297	R3053	30
93932	248			INABOX-03	298	R3061	104 111
93933	248	CB329	86 150	INABOX-03G	298	R3075	80
98014	211	CC08BC	6	INABOX-04	299	R3095	242
A103	305	CC08NM	12	INABOX-04G	299	R3153	31
A107	305	CL06BC	5	M8101	262	R3161	105 112
A108	305	CL06NM	11	M8102	257 261	R3175	81
A111	305	CL14BC	4	M8103	257 261	R3195	243
A203	306	CL14NM	10	M8201	262	R3253	31
A207	306	CL16BC	5	M8203	259		
A208	306	CL16NM	11				
A211	306						

INDEX

CODE	PAGE	CODE	PAGE	CODE	PAGE	CODE	PAGE
R3261	106 112	R9275	82	S8384	180	SF-T-02	235
R3275	81	R9295	251	S8395	251	SF-U-01	216
R3295	244	R9353	33	S9276	170	SF-U-01G	216
R3353	32	R9361	107 113	S9284	180	SF-U-02	218
R3361	106 112	R9375	82	S9295	251	SF-U-02G	218
R3375	81	R9395	251	S9376	170	SF-U-03	220
R3395	245	S0695	249	S9384	180	SF-U-03G	220
R3453	32	S3076	168	S9395	251	SF-U-04	222
R3461	106 113	S3084	178	SF-D-01	217	SF-U-04G	222
R3475	82	S3095	242	SF-D-01G	217	SF-U-05	224
R3495	246	S3176	169	SF-D-02	219	SF-U-05G	224
R4075	83	S3184	179	SF-D-02G	219	SF-U-06	225
R4095	253	S3195	243	SF-D-03	221	SF-U-06G	225
R4275	83	S3276	169	SF-D-03G	221	SF-U-07	226
R4295	253	S3284	179	SF-D-04	223	SF-U-07G	226
R8253	32	S3295	244	SF-D-04G	223	SF-U-08	227
R8261	106 113	S33295	244	SF-D-05	228	SF-U-08G	227
R8275	82	S3376	169	SF-D-05G	228	SR0695	249
R8295	251	S3384	179	SF-D-06	229	SR3051	88
R8353	32	S3395	245	SF-D-06G	229	SR3095	242
R8361	107 113	S3476	170	SF-D-07	230	SR3151	89
R8375	82	S3484	180	SF-D-07G	230	SR3195	243
R8395	251	S3495	246	SF-D-08	231	SR3251	89
R9253	32	S4095	253	SF-D-08G	231	SR3295	244
R9261	106 113	S4295	253	SF-D-09	232	SR3351	89
		S8276	170	SF-D-09G	232	SR3395	245
		S8284	180	SF-D-10	233	SR3451	90
		S8295	251	SF-D-10G	233	SR3495	246
		S8376	170	SF-T-01	234	SR3595	247

CODE	PAGE
SR8251	90
SR8295	251
SR8351	90
SR8395	251
SR9251	90
SR9295	251
SR9351	90
SR9395	251
SRH3595L	247
SRH3595R	247
SRM00BC	7
SRM00NM	13
SRM01BC	8
SRM01NM	14
SRM02BC	8
SRM02NM	14
SRM03BC	8
SRM03NM	14
SRM04BC	9
SRM04NM	15
SRM21BC	9
SRM21NM	15
SRM22BC	9
SRM22NM	15
SRM31BC	9
SRM31NM	15
SRM32BC	9
SRM32NM	15
T-12000	242

CODE	PAGE
T-12001	243
T-12002	244
T-12003	245
T-12004	246
T-12005	247
T-12123	251
UR06BC	5
UR06NM	11
UR14BC	4
UR14NM	10
UR16BC	5
UR16NM	11
UR20BC	4
UR20NM	10
X7510	70
X7512	70
X7513	71
X7514	70
X7526	72
X75N83	70
X75N85	71
X75N95	71
X7612	192
X7613	193
X7614	192
X7616	193
X7626	193
X76N85	194
X76N95	194

CODE	PAGE
X7702	192
X7710	192
X7713	193
X77N85	195
X7816	193
X7826	194
X7910	192

WARRANTY

Aquabross offers a lifetime warranty against defects in materials and workmanship under normal conditions of use, care and maintenance of the product(s), for as long as the original purchaser owns their home. The warranty applies only when the product is purchased from an authorized Aquabross dealer. It is not transferable and is limited to products sold and installed in Canada and the United States.

OUR WARRANTIES FOR RESIDENTIAL APPLICATIONS

- Limited lifetime warranty for ceramic disc cartridges.
- Five (5) year warranty for all other cartridges (thermostatic cartridges, diverters, check stop mechanisms etc.).
- Limited lifetime warranty for the polished chrome, electro black, stainless steel and PVD finishes.
- Three (3) year warranty for all other finishes.
- Two (2) year warranty for electronic faucets and components (batteries are not covered by our warranty).
- Five (5) year warranty for all other Aquabross product(s) and parts.

OUR WARRANTY FOR COMMERCIAL / INDUSTRIAL APPLICATIONS

- All Aquabross products and parts will be warranted for two (2) years.

OUR WARRANTY ON FINISHES

Polished chrome, electro black, stainless steel and PVD finishes carry a limited lifetime warranty against defects. All other Aquabross finishes are warranted for three (3) years. Finishes on drains are not covered by the warranty, nor the normal wear of any finish. Normal wear and tear is the expected decline in the condition of a product/finish due to normal everyday use. We highly recommend you carefully read the care and maintenance detailed instructions given on page xix of this catalogue, or visit our website aquabross.com/aquabross/finishes.

OUR COMMITMENT

We will repair or replace, free of charge, during the applicable warranty periods listed above, any product, part or finish that is proven defective in material and/or workmanship under normal installation, condition of use, care and maintenance of the product(s). Replacement parts for discontinued products will be made available, under warranty or not, until stock lasts. Under the period(s) of the warranty listed above, if the required replacement product, part or finish is no longer available, an equivalence will be recommended and provided, free of charge.

OUR WARRANTY EXCLUSIONS:

- Damage caused by inadequate installation, misuse, lack of care and maintenance of the product(s).
- Surface damage caused from using abrasive products, such as detergents.
- Corrosion resulting from exposition to chemically reactive products, such as Chlorine.
- Damage caused by hard water, calcareous deposits or sediments.
- Damage or loss occurred by a natural calamity such as fire, earthquake, flood, thunder, electrical storm.
- The installation of any Aquabross products by a non-accredited professional.
- Any labor or shipping charges, or damages whatsoever incurred in whole or in part from installation, removal, re-installation, repair or replacement of any Aquabross product or part, as well as any incidental or consequential damages, expenses, losses, direct or indirect, arising from any cause whatsoever.

OUR WARRANTY CLAIM PROCESS

To exercise our warranty, a proof of purchase – such as a copy of invoice - must be made available to our distribution center. Depending on the complexity of the defective product, an inspection can be required prior to approving the warranty claim.

North American Distribution Center (Canada & USA):

AD-WATERS
Technical Service Center
9805 Clark street
Montréal, Québec H3L 2R5

1 888 239-9336
tech@ad-waters.com

For international requests: communications@aquabross.com

ABOUT

CARE & MAINTENANCE

Do not allow water residues to come into prolonged contact with the surface finish. After each use, gently dry the product surface with a clean soft cloth to prevent water-spotting and mineral build-up. Water stains and accumulation of minerals weaken the protective coating, eventually leading to peel off.

Clean the surface regularly using a pH neutral clear liquid soap, water and a soft cloth. Rinse away any traces of soap and gently dry with a soft clean cloth. Occasional application of Flitz Faucet Wax Plus is also recommended. The application of this wax based product leaves a protective layer that repels water, thereby providing extra protection against tarnishing.

Avoid abrasive and harsh cleaning products (detergents, caustic, acidic, antibacterial, ammonia- or bleach-containing products, organic solvents, lime scale and clog removers, brass and silver cleaners, etc.). The use of these products can damage the finish and will void the warranty. We recommend covering the fixture with a towel when using any of the listed products in order to prevent damage by splashing.

Residues left by personal products such as soap, toothpaste and shampoo can damage the finish. Always rinse these residues away with clean water and wipe dry.

Due to the characteristics of the Aquabross custom finishes and their appropriate maintenance durability dependency, the warranty for custom finish products is three (3) years. There are no returns on custom finish products.



OPTIONAL LOW FLOW AERATORS

Adjustments for specific restrictions can be made on most of our lavatory bathroom faucets in order to coordinate with regional flow rate allowances. A low flow restrictor is sold at \$10 per unit. Please contact your local Aquabross representative for additional details.

PRODUCT CERTIFICATION

Complying with North American plumbing standards and guaranteeing environmental products of the highest quality is our top priority.



Product specifications and pricing shown in this catalogue are subject to change without notice or obligation. Aquabross also reserves the right to change or discontinue certain models without notice or obligation. The visual representation of the products and finishes in this catalogue may differ from the actual items.

BATHROOM FAUCETS



Photo credit: Tomlenovich Design, photography by Giorgio Locatelli

MARMO

AVAILABLE FINISHES

polished chrome



 MARMO collection is also available
in Aquabrand's custom finishes
(10 weeks lead time, see finish chart p.vii)

CHOICE OF MARBLE



white
Carrara



black
Marquina





MARMO

TOSCA

OTTO

VITTORIO

REGENCY

ETNA

CUT



MB2

XROUND

GEO

TIME

BLOK

VOLARE

FOLIA



MIDTOWN

MUST

BLADE

LOVEME

ALPHA

METRO

CHICANE



B-JOU

MADISON

XSQUARE

STREEM

SOLO

DRAINS

MARMO CARRARA



CL14BC single-hole lavatory faucet

- solid brass and natural marble construction
- crystal clear water flow
- single volume and temperature joystick control
- press pop-up drain with overflow included
- 3/8" connection

height: 8^{15/16"}overall projection: 6^{3/16"}

flow rate: 1.2 gpm



ABCA14769

Polished Chrome

\$895

Custom Finish

\$1250

UR14BC urban single-hole lavatory faucet

- solid brass and natural marble construction
- crystal clear water flow
- single volume and temperature joystick control
- press pop-up drain with overflow included
- 3/8" connection

height: 7^{15/16"}overall projection: 7^{7/16"}

flow rate: 1.5 gpm



ABCA14769

Polished Chrome

\$895

Custom Finish

\$1250

CL20BC tall single-hole lavatory faucet

- solid brass and natural marble construction
- crystal clear water flow
- single volume and temperature joystick control
- press pop-up drain with overflow included
- 3/8" connection

height: 12^{13/16"}overall projection: 7^{3/8"}

flow rate: 1.2 gpm



ABCA14769

Polished Chrome

\$1295

Custom Finish

\$1795

UR20BC urban tall single-hole lavatory faucet

- solid brass and natural marble construction
- crystal clear water flow
- single volume and temperature joystick control
- press pop-up drain with overflow included
- 3/8" connection

height: 12^{1/8"}overall projection: 7^{7/8"}

flow rate: 1.5 gpm



ABCA14769

Polished Chrome

\$1295

Custom Finish

\$1795

CL29BC wallmount 8" c.c. lavatory faucet

- **rough included**
- solid brass and natural marble construction
- crystal clear water flow
- drain not included, see p.212 for options
- 1/2" connection

height: 4"

overall projection: 9^{1/4"}

flow rate: 1.2 gpm

ABCA14917 / HOT
ABCA14918 / COLD

Polished Chrome

\$1495

Custom Finish

\$1895

MARMO CARRARA

MARMO

TOSCA

OTTO

VITTORIO

REGENCY

ETNA

CUT



MB2

XROUND

GEO

TIME

BLOK

VOLARE

FOLIA



MIDTOWN

MUST

BLADE

LOVEME

ALPHA

METRO

CHICANE



B-JOU

MADISON

X SQUARE

STREEM

SOLO

DRAINS

CL28BC wallmount lavatory faucet



• rough included

- solid brass and natural marble construction
- crystal clear water flow
- drain not included, see p.212 for options
- 1/2" connection

height: 2^{15/16"}

overall projection: 8^{1/16"}

flow rate: 1.2 gpm



ABCA14769

Polished Chrome

\$1150



Custom Finish

\$1450

CL16BC widespread lavatory faucet



- solid brass and natural marble construction
- crystal clear water flow
- press pop-up drain with overflow included
- 1/2" connection

height: 8^{1/4"}

overall projection: 6^{3/16"}

flow rate: 1.2 gpm



ABCA02135 / HOT
ABCA03930 / COLD

Polished Chrome

\$1650



Custom Finish

\$1995

UR16BC urban widespread lavatory faucet



- solid brass and natural marble construction
- crystal clear water flow
- press pop-up drain with overflow included
- 1/2" connection

height: 8^{1/16"}

overall projection: 7^{7/16"}

flow rate: 1.5 gpm



ABCA02135 / HOT
ABCA03930 / COLD

Polished Chrome

\$1650



Custom Finish

\$1995

CL06BC 5-piece deckmount tub filler with diverter and handshower



- solid brass and natural marble construction
- crystal clear water flow
- hidden handshower with 5' double-helix hose
- 1/2" connection

height: 7^{7/16"}

overall projection: 6^{11/16"}

flow rate: (tub filler) 6 gpm (handshower) 2.5 gpm



ABCA02135 / HOT
ABCA03930 / COLD

Polished Chrome

\$3250



Custom Finish

\$3850

UR06BC urban 5-piece deckmount tub filler with diverter and handshower



- solid brass and natural marble construction
- crystal clear water flow
- hidden handshower with 5' double-helix hose
- 1/2" connection

height: 7"

overall projection: 7^{1/16"}

flow rate: (tub filler) 6 gpm (handshower) 2.5 gpm



ABCA02135 / HOT
ABCA03930 / COLD

Polished Chrome

\$3250



Custom Finish

\$3850



MARMO

TOSCA

OTTO

VITTORIO

REGENCY

ETNA

CUT



MB2

XROUND

GEO

TIME

BLOK

VOLARE

FOLIA



MIDTOWN

MUST

BLADE

LOVEME

ALPHA

METRO

CHICANE



B-JOU

MADISON

XSQUARE

STREEM

SOLO

DRAINS

MARMO CARRARA



CL85BC floormount tub filler with hidden handshower

- solid brass and natural marble construction
- crystal clear water flow
- hot and cold water temperature controls
- dual water output
- hidden handshower with 5' grey nylon hose
- 1/2" connection

height: 29^{1/2"}

overall projection: 13^{3/4"}

flow rate: (tub filler) 6.5 gpm
(handshower) 2.5 gpm



ABCA09742

Polished Chrome

\$5595



Custom Finish

\$6995



CL32BC wallmount tub spout

- solid brass and natural marble construction
- crystal clear water flow
- non diverter spout
- 1/2" connection

height: 3^{13/16"}

overall projection: 8^{5/16"}

flow rate: depends on capacity of the valve

Polished Chrome

\$495



Custom Finish

\$695



CL24BC single-hole bidet with swivel spray

- solid brass and natural marble construction
- single volume and temperature joystick control
- press pop-up drain with overflow included
- 3/8" connection

height: 7"

overall projection: 5^{11/16"}

flow rate: 1.5 gpm



ABCA14769

Polished Chrome

\$995



Custom Finish

\$1295



CC08BC wallmount hook

diameter: 2^{11/16"}

overall projection: 1^{3/8"}

Polished Chrome

\$250



Custom Finish

\$350

Shower Valves & Trim Set Solutions

(for complete program, see pages 241 - 292)



SRM00BC plate and handle trim set

- 4^{1/4}" x 7^{7/8}" x 1/8"
- requires # 12000 TURBO thermostatic valve with a choice of a shut-off valve (# 1206) or a 2-3 way diverter (# 61934)

Polished Chrome **\$440**

Custom Finish **\$635**

T12000 TURBO thermostatic valve 3/4" - 1/2"

Rough **\$455**



SR0695 plate and handle trim set

- 3^{1/4}" x 4^{1/4}" x 1/8"
- requires # 1206 shut-off valve

Polished Chrome **\$160**

Custom Finish **\$320**

1206 1/2" shut-off valve

Rough **\$165**



2-way

93922 plate and handle trim set with 2-way diverter

- **WITH STOP – shared functions**
- replaces the functionality of 2 shut-off valves
- 2^{3/4}" x 2^{3/4}" x 1/8"
- requires # 61934 diverter

Polished Chrome **\$275**

Custom Finish **\$550**

61934 2 & 3 way diverter

Rough **\$195**



2-way

93822 plate and handle trim set with 2-way diverter

- **WITH STOP – 1 function at a time**
- replaces the functionality of 2 shut-off valves
- 2^{3/4}" x 2^{3/4}" x 1/8"
- requires # 61934 diverter

Polished Chrome **\$275**

Custom Finish **\$550**

61934 2 & 3 way diverter

Rough **\$195**



MARMO

TOSCA

OTTO

VITTORIO

REGENCY

ETNA

CUT

MARMO CARRARA



3-way

93932 plate and handle trim set with 3-way diverter**• WITH STOP – shared functions**

- replaces the functionality of 3 shut-off valves
- 2^{3/4}" x 2^{3/4}" x 1/8"
- requires # 61934 diverter

Polished Chrome

\$275

Custom Finish

\$550**61934 2 & 3 way diverter**

Rough

\$195

3-way

93832 plate and handle trim set with 3-way diverter**• WITH STOP – 1 function at a time**

- replaces the functionality of 3 shut-off valves
- 2^{3/4}" x 2^{3/4}" x 1/8"
- requires # 61934 diverter

Polished Chrome

\$275

Custom Finish

\$550**61934 2 & 3 way diverter**

Rough

\$195**SRM01BC plate and handle trim set**

- 4^{1/4}" x 11" x 1/8"
- requires # 12001 TURBO thermostatic valve

Polished Chrome

\$585

Custom Finish

\$925**T12001 TURBO thermostatic valve with 1 shut-off valve - 3/4" - 1/2"**

Rough

\$625**SRM02BC plate and handle trim set**

- 4^{1/4}" x 13^{3/4}" x 1/8"
- requires # 12002 TURBO thermostatic valve

Polished Chrome

\$735

Custom Finish

\$1225**T12002 TURBO thermostatic valve with 2 shut-off valve - 3/4" - 1/2"**

Rough

\$795**SRM03BC plate and handle trim set**

- 4^{1/4}" x 16^{3/4}" x 1/8"
- requires # 12003 TURBO thermostatic valve

Polished Chrome

\$890

Custom Finish

\$1535**T12003 TURBO thermostatic valve with 3 shut-off valve - 3/4" - 1/2"**

Rough

\$965

DRAINS

SOLO

STREEM

XSQUARE

MADISON

B-JOU



CHICANE

METRO

ALPHA

LOVEME

BLADE

MUST

MIDTOWN



FOLIA

VOLARE

BLOK

TIME

GEO

XROUND

MB2



MARMO CARRARA



SRM04BC plate and handle trim set

- 4^{1/4}"x19^{5/8}"x1/8"
- requires #12004 TURBO thermostatic valve

Polished Chrome **\$1040**

Custom Finish **\$1835**

T12004 TURBO thermostatic valve with 4 shut-off valve - 3/4" - 1/2"

Rough **\$1135**



2-way

SRM22BC plate and handle trim set with 2-way diverter

- shared functions
- 4^{1/4}"x12"x1/8"
- requires #T12123 Turbo Uniplex thermostatic valve

Polished Chrome **\$700**

Custom Finish **\$945**

T12123 TURBO UNIPLEX thermostatic valve 3/4" - 1/2"

Rough **\$495**



2-way

SRM21BC plate and handle trim set with 2-way diverter

- 1 function at a time
- 4^{1/4}"x12"x1/8"
- requires #T12123 Turbo Uniplex thermostatic valve

Polished Chrome **\$700**

Custom Finish **\$945**

T12123 TURBO UNIPLEX thermostatic valve 3/4" - 1/2"

Rough **\$495**



3-way

SRM32BC plate and handle trim set with 3-way diverter

- shared functions
- 4^{1/4}"x12"x1/8"
- requires #T12123 Turbo Uniplex thermostatic valve

Polished Chrome **\$700**

Custom Finish **\$945**

T12123 TURBO UNIPLEX thermostatic valve 3/4" - 1/2"

Rough **\$495**



3-way

SRM31BC plate and handle trim set with 3-way diverter

- 1 function at a time
- 4^{1/4}"x12"x1/8"
- requires #T12123 Turbo Uniplex thermostatic valve

Polished Chrome **\$700**

Custom Finish **\$945**

T12123 TURBO UNIPLEX thermostatic valve 3/4" - 1/2"

Rough **\$495**



MARMO

TOSCA

OTTO

VITTORIO

REGENCY

ETNA

CUT



MB2

XROUND

GEO

TIME

BLOK

VOLARE

FOLIA



MIDTOWN

MUST

BLADE

LOVEME

ALPHA

METRO

CHICANE



B-JOU

MADISON

XSQUARE

STREEM

SOLO

DRAINS

MARMO MARQUINA

CL14NM single-hole lavatory faucet



- solid brass and natural marble construction
- crystal clear water flow
- single volume and temperature joystick control
- press pop-up drain with overflow included
- 3/8" connection

height: 8^{15/16"}
 overall projection: 6^{3/16"}
 flow rate: 1.2 gpm



Polished Chrome **\$895**

Custom Finish **\$1250**

UR14NM urban single-hole lavatory faucet



- solid brass and natural marble construction
- crystal clear water flow
- single volume and temperature joystick control
- press pop-up drain with overflow included
- 3/8" connection

height: 7^{15/16"}
 overall projection: 7^{7/16"}
 flow rate: 1.5 gpm



Polished Chrome **\$895**

Custom Finish **\$1250**

CL20NM tall single-hole lavatory faucet



- solid brass and natural marble construction
- crystal clear water flow
- single volume and temperature joystick control
- press pop-up drain with overflow included
- 3/8" connection

height: 12^{13/16"}
 overall projection: 7^{3/8"}
 flow rate: 1.2 gpm



Polished Chrome **\$1295**

Custom Finish **\$1795**

UR20NM urban tall single-hole lavatory faucet



- solid brass and natural marble construction
- crystal clear water flow
- single volume and temperature joystick control
- press pop-up drain with overflow included
- 3/8" connection

height: 12^{1/8"}
 overall projection: 7^{7/8"}
 flow rate: 1.5 gpm



Polished Chrome **\$1295**

Custom Finish **\$1795**

CL29NM wallmount 8" c.c. lavatory faucet



- **rough included**
- solid brass and natural marble construction
- crystal clear water flow
- drain not included, see p.212 for options
- 1/2" connection

height: 4"
 overall projection: 9^{1/4"}
 flow rate: 1.2 gpm

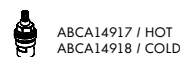

Polished Chrome **\$1495**

Custom Finish **\$1895**

MARMO MARQUINA

MARMO

TOSCA

OTTO

VITTORIO

REGENCY

ETNA

CUT



MB2

XROUND

GEO

TIME

BLOK

VOLARE

FOLIA



MIDTOWN

MUST

BLADE

LOVEME

ALPHA

METRO

CHICANE



B-JOU

MADISON

X SQUARE

STREAM

SOLO

DRAINS

CL28NM wallmount lavatory faucet



- rough included

- solid brass and natural marble construction
- crystal clear water flow
- drain not included, see p.212 for options
- 1/2" connection

height: 2^{15/16"}

overall projection: 8^{1/16"}

flow rate: 1.2 gpm



ABCA14769

Polished Chrome

\$1150



Custom Finish

\$1450

CL16NM widespread lavatory faucet



- solid brass and natural marble construction
- crystal clear water flow
- press pop-up drain with overflow included
- 1/2" connection

height: 8^{1/4"}

overall projection: 6^{3/16"}

flow rate: 1.2 gpm



ABCA02135 / HOT
ABCA03930 / COLD

Polished Chrome

\$1650



Custom Finish

\$1995

UR16NM urban widespread lavatory faucet



- solid brass and natural marble construction
- crystal clear water flow
- press pop-up drain with overflow included
- 1/2" connection

height: 8^{1/16"}

overall projection: 7^{7/16"}

flow rate: 1.5 gpm



ABCA02135 / HOT
ABCA03930 / COLD

Polished Chrome

\$1650



Custom Finish

\$1995

CLO6NM 5-piece deckmount tub filler with diverter and handshower



- solid brass and natural marble construction
- crystal clear water flow
- hidden handshower with 5' double-helix hose
- 1/2" connection

height: 7^{7/16"}

overall projection: 6^{11/16"}

flow rate: (tub filler) 6 gpm (handshower) 2.5 gpm



ABCA02135 / HOT
ABCA03930 / COLD

Polished Chrome

\$3250



Custom Finish

\$3850

UR06NM urban 5-piece deckmount tub filler with diverter and handshower



- solid brass and natural marble construction
- crystal clear water flow
- hidden handshower with 5' double-helix hose
- 1/2" connection

height: 7"

overall projection: 7^{1/16"}

flow rate: (tub filler) 6 gpm (handshower) 2.5 gpm



ABCA02135 / HOT
ABCA03930 / COLD

Polished Chrome

\$3250



Custom Finish

\$3850



MARMO

TOSCA

OTTO

VITTORIO

REGENCY

ETNA

CUT



MB2

XROUND

GEO

TIME

BLOK

VOLARE

FOLIA



MIDTOWN

MUST

BLADE

LOVEME

ALPHA

METRO

CHICANE



B-JOU

MADISON

X SQUARE

STREEM

SOLO

DRAINS

MARMO MARQUINA



CL85NM floormount tub filler with hidden handshower

- solid brass and natural marble construction
- crystal clear water flow
- hot and cold water temperature controls
- dual water output
- hidden handshower with 5' grey nylon hose
- 1/2" connection

height: 29^{1/2"}

overall projection: 13^{3/4"}

flow rate: (tub filler) 6.5 gpm
(handshower) 2.5 gpm



Polished Chrome

\$5595

Custom Finish

\$6995



CL32NM wallmount tub spout

- solid brass and natural marble construction
- crystal clear water flow
- non diverter spout
- 1/2" connection

height: 3^{13/16"}

overall projection: 8^{5/16"}

flow rate: depends on capacity of the valve

Polished Chrome

\$495

Custom Finish

\$695



CL24NM single-hole bidet with swivel spray

- solid brass and natural marble construction
- single volume and temperature joystick control
- press pop-up drain with overflow included
- 3/8" connection

height: 7"

overall projection: 5^{11/16"}

flow rate: 1.5 gpm



Polished Chrome

\$995

Custom Finish

\$1295



CC08NM wallmount hook

diameter: 2^{11/16"}

overall projection: 1^{3/8"}

Polished Chrome

\$250

Custom Finish

\$350

MARMO MARQUINA

Shower Valves & Trim Set Solutions

(for complete program, see pages 241 - 292)

SRM00NM plate and handle trim set

- 4^{1/4}" x 7^{7/8}" x 1/8"
- requires # 12000 TURBO thermostatic valve with a choice of a shut-off valve (# 1206) or a 2-3 way diverter (# 61934)

 Polished Chrome **\$440**

 Custom Finish **\$635**
T12000 TURBO thermostatic valve 3/4" - 1/2"

 Rough **\$455**

SR0695 plate and handle trim set

- 3^{1/4}" x 4^{1/4}" x 1/8"
- requires # 1206 shut-off valve

 Polished Chrome **\$160**

 Custom Finish **\$320**
1206 1/2" shut-off valve

 Rough **\$165**

2-way

93922 plate and handle trim set with 2-way diverter

- **WITH STOP – shared functions**
- replaces the functionality of 2 shut-off valves
- 2^{3/4}" x 2^{3/4}" x 1/8"
- requires # 61934 diverter

 Polished Chrome **\$275**

 Custom Finish **\$550**
61934 2 & 3 way diverter

 Rough **\$195**

2-way

93822 plate and handle trim set with 2-way diverter

- **WITH STOP – 1 function at a time**
- replaces the functionality of 2 shut-off valves
- 2^{3/4}" x 2^{3/4}" x 1/8"
- requires # 61934 diverter

 Polished Chrome **\$275**

 Custom Finish **\$550**
61934 2 & 3 way diverter

 Rough **\$195**

MB2

XROUND

GEO

TIME

BLOK

VOLARE

FOLIA



MIDTOWN

MUST

BLADE

LOVEME

ALPHA

METRO

CHICANE



B-JOU

MADISON

XSQUARE

STREAM

SOLO

DRAINS



MARMO

TOSCA

OTTO

VITTORIO

REGENCY

ETNA

CUT

MARMO MARQUINA



3-way

93932 plate and handle trim set with 3-way diverter**• WITH STOP – shared functions**

- replaces the functionality of 3 shut-off valves
- 2^{3/4}" x 2^{3/4}" x 1/8"
- requires # 61934 diverter

Polished Chrome

\$275

Custom Finish

\$550**61934 2 & 3 way diverter**

Rough

\$195

3-way

93832 plate and handle trim set with 3-way diverter**• WITH STOP – 1 function at a time**

- replaces the functionality of 3 shut-off valves
- 2^{3/4}" x 2^{3/4}" x 1/8"
- requires # 61934 diverter

Polished Chrome

\$275

Custom Finish

\$550**61934 2 & 3 way diverter**

Rough

\$195**SRM01NM plate and handle trim set**

- 4^{1/4}" x 11" x 1/8"
- requires # 12001 TURBO thermostatic valve

Polished Chrome

\$585

Custom Finish

\$925**T12001 TURBO thermostatic valve with 1 shut-off valve - 3/4" - 1/2"**

Rough

\$625**SRM02NM plate and handle trim set**

- 4^{1/4}" x 13^{3/4}" x 1/8"
- requires # 12002 TURBO thermostatic valve

Polished Chrome

\$735

Custom Finish

\$1295**T12002 TURBO thermostatic valve with 2 shut-off valve - 3/4" - 1/2"**

Rough

\$795**SRM03NM plate and handle trim set**

- 4^{1/4}" x 16^{3/4}" x 1/8"
- requires # 12003 TURBO thermostatic valve

Polished Chrome

\$890

Custom Finish

\$1535**T12003 TURBO thermostatic valve with 3 shut-off valve - 3/4" - 1/2"**

Rough

\$965

DRAINS

SOLO

STREEM

XSQUARE

MADISON

B-JOU



CHICANE

METRO

ALPHA

LOVEME

BLADE

MUST

MIDTOWN



FOLIA

VOLARE

BLOK

TIME

GEO

XROUND

MB2



MARMO MARQUINA

MARMO

TOSCA

OTTO

VITTORIO

REGENCY

ETNA

CUT



MB2

XROUND

GEO

TIME

BLOK

VOLARE

FOLIA



MIDTOWN

MUST

BLADE

LOVEME

ALPHA

METRO

CHICANE



B-JOU

MADISON

XSQUARE

STREAM

SOLO

DRAINS



SRM04NM plate and handle trim set
 • 4^{1/4}"x19^{5/8}"x1/8"
 • requires #12004 TURBO thermostatic valve

Polished Chrome **\$1040**
 Custom Finish **\$1835**

T12004 TURBO thermostatic valve with 4 shut-off valve - 3/4" - 1/2"

Rough **\$1135**



2-way

SRM22NM plate and handle trim set with 2-way diverter
 • shared functions
 • 4^{1/4}"x12"x1/8"
 • requires #T12123 Turbo Uniplex thermostatic valve

Polished Chrome **\$700**
 Custom Finish **\$945**

T12123 TURBO UNIPLEX thermostatic valve 3/4" - 1/2"

Rough **\$495**



2-way

SRM21NM plate and handle trim set with 2-way diverter
 • 1 function at a time
 • 4^{1/4}"x12"x1/8"
 • requires #T12123 Turbo Uniplex thermostatic valve

Polished Chrome **\$700**
 Custom Finish **\$945**

T12123 TURBO UNIPLEX thermostatic valve 3/4" - 1/2"

Rough **\$495**



3-way

SRM32NM plate and handle trim set with 3-way diverter
 • shared functions
 • 4^{1/4}"x12"x1/8"
 • requires #T12123 Turbo Uniplex thermostatic valve

Polished Chrome **\$700**
 Custom Finish **\$945**

T12123 TURBO UNIPLEX thermostatic valve 3/4" - 1/2"

Rough **\$495**



3-way

SRM31NM plate and handle trim set with 3-way diverter
 • 1 function at a time
 • 4^{1/4}"x12"x1/8"
 • requires #T12123 Turbo Uniplex thermostatic valve

Polished Chrome **\$700**
 Custom Finish **\$945**

T12123 TURBO UNIPLEX thermostatic valve 3/4" - 1/2"

Rough **\$495**

TOSCA

AVAILABLE FINISHES

polished chrome



black (powder coat)



CHOICE OF HANDLES



TOSCA
metal



TOSCA STAR
crystal







MARMO

TOSCA

OTTO

VITTORIO

REGENCY

ETNA

CUT



MB2

XROUND

GEO

TIME

BLOK

VOLARE

FOLIA



MIDTOWN

MUST

BLADE

LOVEME

ALPHA

METRO

CHICANE



B-JOU

MADISON

XSQUARE

STREEM

SOLO

TOSCA



34114 single-hole lavatory faucet

- solid brass construction
- crystal clear water flow
- press pop-up drain with overflow included
- 3/8" connection

height: 6^{11/16"}
 overall projection: 6"
 flow rate: 2.2 gpm



ABCA34075

Polished Chrome **\$650**
 Black **\$850**



34014 single-hole lavatory faucet with two handles

- solid brass construction
- crystal clear water flow
- press pop-up drain with overflow included
- 3/8" connection

height: 11^{1/16"}
 overall projection: 8^{1/16"}
 flow rate: 2.2 gpm

ABCA30911 / HOT
ABCA30921 / COLD

Polished Chrome **\$1350**
 Black **\$1750**



34016 widespread lavatory faucet

- solid brass construction
- crystal clear water flow
- press pop-up drain with overflow included
- 1/2" connection

height: 11^{1/4"}
 overall projection: 8^{1/16"}
 flow rate: 2.2 gpm

ABCA30911 / HOT
ABCA30921 / COLD

Polished Chrome **\$1495**
 Black **\$1950**



34029 wallmount 8" c.c. lavatory faucet

- solid brass construction
- crystal clear water flow
- drain not included, see page 212 for options
- rough-in not included, order #34829

height: 2^{3/16"} overall projection: 9^{7/16"}
 flow rate: 2.2 gpm

ABCA30911 / HOT
ABCA30921 / COLD

Polished Chrome **\$1195**
 Black **\$1550**



34829 rough-in for wallmount faucet #34029

- 1/2" NPT connection

Rough-in **\$295**



34004 wallmount tub filler with handshower

- solid brass construction
- crystal clear water flow
- 2 independent single volume and temperature mixing valves
- handshower with 5' reinforced pvc hose
- rough-in not included, order # **CB304**

height: 10^{5/8"} overall projection: 7"
 flow rate: (tub filler) 5.5 gpm (handshower) 2.5 gpm

Polished Chrome **\$1695**
 Black **\$2195**

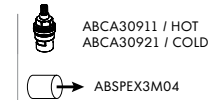

CB304 rough-in for wallmount tub filler #34004

- 1/2" NPT male connection

Rough-in **\$795**

34124 single-hole bidet faucet with swivel spray

- solid brass construction
- aerated water flow
- press pop-up drain with overflow included
- 3/8" connection

height: 5"
 overall projection: 5^{3/4"}
 flow rate: 2.2 gpm

Polished Chrome **\$695**
 Black **\$895**





MARMO

TOSCA

OTTO

VITTORIO

REGENCY

ETNA

CUT



MB2

XROUND

GEO

TIME

BLOK

VOLARE

FOLIA



MIDTOWN

MUST

BLADE

LOVEME

ALPHA

METRO

CHICANE



B-JOU

MADISON

XSQUARE

STREEM

SOLO

DRAINS

TOSCA STAR



34514 single-hole lavatory faucet with two handles

- solid brass construction
- crystal handles
- crystal clear water flow
- press pop-up drain with overflow included
- 3/8" connection

height: 11^{1/16"}
 overall projection: 8^{1/16"}
 flow rate: 2.2 gpm

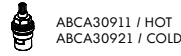

Polished Chrome **\$1550**
 Black **\$1950**



34516 widespread lavatory faucet

- solid brass construction
- crystal handles
- crystal clear water flow
- press pop-up drain with overflow included
- 1/2" connection

height: 11^{1/4"}
 overall projection: 8^{1/16"}
 flow rate: 2.2 gpm

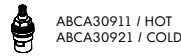

Polished Chrome **\$1695**
 Black **\$2150**



34529 wallmount 8" c.c. lavatory faucet

- solid brass construction
- crystal handles
- crystal clear water flow
- drain not included, see page 212 for options
- rough-in not included, order #35829

height: 2^{3/16"} overall projection: 9^{7/16"}
 flow rate: 2.2 gpm

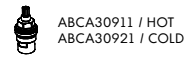

Polished Chrome **\$1395**
 Black **\$1750**



35829 rough-in for wallmount faucet #34529

- 1/2" NPT connection

Rough-in **\$295**

Shower Valves & Trim Set Solutions

(for complete program, see pages 241 - 292)



S3095 plate and handle trim set

- 4^{1/4}"x7^{7/8}"x1/8"
- requires # 12000 TURBO thermostatic valve with a choice of a shut-off valve (#1206) or a 2-3 way diverter (#61934)

Polished Chrome **\$195**
Black **\$340**

T12000 TURBO thermostatic valve 3/4" - 1/2"

Rough **\$455**



S0695 plate and handle trim set

- 3^{1/4}"x4^{1/4}"x1/8"
- requires # 1206 shut-off valve

Polished Chrome **\$160**
Black **\$280**

1206 1/2" shut-off valve

Rough **\$165**

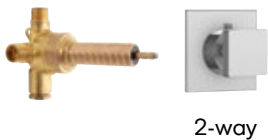

2-way

93923 plate and handle trim set with 2-way diverter

- **WITH STOP – shared functions**
- replaces the functionality of 2 shut-off valves
- 2^{3/4}" x 2^{3/4}" x 1/8"
- requires # 61934 diverter

Polished Chrome **\$275**
Black **\$395**

61934 2 & 3 way diverter

Rough **\$195**

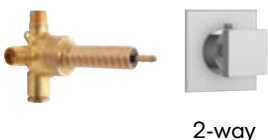

2-way

93823 plate and handle trim set with 2-way diverter

- **WITH STOP – 1 function at a time**
- replaces the functionality of 2 shut-off valves
- 2^{3/4}" x 2^{3/4}" x 1/8"
- requires # 61934 diverter

Polished Chrome **\$275**
Black **\$395**

61934 2 & 3 way diverter

Rough **\$195**



MARMO

TOSCA

OTTO

VITTORIO

REGENCY

ETNA

CUT



MB2

XROUND

GEO

TIME

BLOK

VOLARE

FOLIA



MIDTOWN

MUST

BLADE

LOVEME

ALPHA

METRO

CHICANE



B-JOU

MADISON

XSQUARE

STREEM

SOLO

TOSCA



3-way

93933 plate and handle trim set with 3-way diverter

• WITH STOP – shared functions

- replaces the functionality of 3 shut-off valves
- 2^{3/4}" x 2^{3/4}" x 1/8"
- requires #61934 diverter

Polished Chrome

\$275

Black

\$395

61934 2 & 3 way diverter

Rough

\$195

3-way

93833 plate and handle trim set with 3-way diverter

• WITH STOP – 1 function at a time

- replaces the functionality of 3 shut-off valves
- 2^{3/4}" x 2^{3/4}" x 1/8"
- requires #61934 diverter

Polished Chrome

\$275

Black

\$395

61934 2 & 3 way diverter

Rough

\$195

S3195 plate and handle trim set

- 4^{1/4}" x 11" x 1/8"
- requires #12001 TURBO thermostatic valve

Polished Chrome

\$340

Black

\$595

T12001 TURBO thermostatic valve with 1 shut-off valve - 3/4" - 1/2"

Rough

\$625

S3295 plate and handle trim set

- 4^{1/4}" x 13^{3/4}" x 1/8"
- requires #12002 TURBO thermostatic valve

Polished Chrome

\$490

Black

\$850

T12002 TURBO thermostatic valve with 2 shut-off valve - 3/4" - 1/2"

Rough

\$795

S3395 plate and handle trim set

- 4^{1/4}" x 16^{3/4}" x 1/8"
- requires #12003 TURBO thermostatic valve

Polished Chrome

\$645

Black

\$1130

T12003 TURBO thermostatic valve with 3 shut-off valve - 3/4" - 1/2"

Rough

\$965

DRAINS

S3495 plate and handle trim set

- 4^{1/4}"x19^{5/8}"x1/8"
- requires #12004 TURBO thermostatic valve

Polished Chrome

\$795

Black

\$1385
T12004 TURBO thermostatic valve with 4 shut-off valve - 3/4" - 1/2"

Rough

\$1135

S8295 plate and handle trim set with 2-way diverter

- shared functions
- 4^{1/4}"x12"x1/8"
- requires #T12123 Turbo Uniplex thermostatic valve

Polished Chrome

\$455

Black

\$795

2-way

T12123 TURBO UNIPLEX thermostatic valve 3/4" - 1/2"

Rough

\$495

S9295 plate and handle trim set with 2-way diverter

- 1 function at a time
- 4^{1/4}"x12"x1/8"
- requires #T12123 Turbo Uniplex thermostatic valve

Polished Chrome

\$455

Black

\$795

2-way

T12123 TURBO UNIPLEX thermostatic valve 3/4" - 1/2"

Rough

\$495

S8395 plate and handle trim set with 3-way diverter

- shared functions
- 4^{1/4}"x12"x1/8"
- requires #T12123 Turbo Uniplex thermostatic valve

Polished Chrome

\$455

Black

\$795

3-way

T12123 TURBO UNIPLEX thermostatic valve 3/4" - 1/2"

Rough

\$495

S9395 plate and handle trim set with 3-way diverter

- 1 function at a time
- 4^{1/4}"x12"x1/8"
- requires #T12123 Turbo Uniplex thermostatic valve

Polished Chrome

\$455

Black

\$795

3-way

T12123 TURBO UNIPLEX thermostatic valve 3/4" - 1/2"

Rough

\$495



MARMO

TOSCA

OTTO

VITTORIO

REGENCY

ETNA

CUT



MB2

XROUND

GEO

TIME

BLOK

VOLARE

FOLIA



MIDTOWN

MUST

BLADE

LOVEME

ALPHA

METRO

CHICANE



B-JOU

MADISON

XSQUARE

STREEM

SOLO

DRAINS

TOSCA



S4095 plate and handle trim set

- 6^{1/2}"x8^{1/4}"x1/8"
- requires #40255 pressure balance valve

Polished Chrome

\$165

Black

\$285

40255 1/2" pressure balance valve for shower

- due to visible rough parts, select matching finish

Polished Chrome

\$235

Black

\$415

S4295 plate and handle trim set

- 6^{1/2}"x8^{1/4}"x1/8"
- requires #42355 pressure balance valve

Polished Chrome

\$195

Black

\$345

42355 1/2" pressure balance valve for tub / shower

- due to visible rough parts, select matching finish

Polished Chrome

\$425

Black

\$745



MARMO

TOSCA

OTTO

VITTORIO

REGENCY

ETNA

CUT



MB2

XROUND

GEO

TIME

BLOK

VOLARE

FOLIA



MIDTOWN

MUST

BLADE

LOVEME

ALPHA

METRO

CHICANE



B-JOU

MADISON

X SQUARE

STREEM

SOLO

DRAINS

OTTO

AVAILABLE FINISHES

polished chrome



brushed nickel



brushed gold



 OTTO collection is also available
in Aquabross' custom finishes
(10 weeks lead time, see finish chart p.vii)







MARMO

TOSCA

OTTO

VITTORIO

REGENCY

ETNA

CUT



MB2

XROUND

GEO

TIME

BLOK

VOLARE

FOLIA



MIDTOWN

MUST

BLADE

LOVEME

ALPHA

METRO

CHICANE



B-JOU

MADISON

XSQUARE

STREEM

SOLO

DRAINS

OTTO



53014 single-hole lavatory faucet

- solid brass construction
- crystal clear water flow
- press pop-up drain with overflow included
- 3/8" connection

height: 6^{1/8"}
 overall projection: 5^{7/8"}
 flow rate: 2.2 gpm



ABCA04076

- Polished Chrome **\$895**
 Brushed Nickel **\$1150**
 Brushed Gold **\$1550**
 Custom Finish **\$1790**



53N10 short widespread lavatory faucet

- solid brass construction
- crystal clear water flow
- press pop-up drain with overflow included
- 1/2" connection

height: 4^{7/16"}
 overall projection: 6^{1/4"}
 flow rate: 2.2 gpm

ABCA90054 / HOT
ABCA90055 / COLD

- Polished Chrome **\$1100**
 Brushed Nickel **\$1430**
 Brushed Gold **\$1895**
 Custom finish **\$2200**



53N16 widespread lavatory faucet

- solid brass construction
- crystal clear water flow
- press pop-up drain with overflow included
- 1/2" connection

height: 7^{1/16"}
 overall projection: 6"
 flow rate: 2.2 gpm

ABCA90054 / HOT
ABCA90055 / COLD

- Polished Chrome **\$1175**
 Brushed Nickel **\$1530**
 Brushed Gold **\$1995**
 Custom Finish **\$2350**



53N29 wallmount 8" c.c. lavatory faucet

- **rough included**
- solid brass construction
- crystal clear water flow
- drain not included, see page 212 for options
- 1/2" NPT female connection

height: 2^{1/2"}
 overall projection: 7^{3/4"}
 flow rate: 2.2 gpm

ABCA90073 / HOT
ABCA90074 / COLD

- Polished Chrome **\$1100**
 Brushed Nickel **\$1430**
 Brushed Gold **\$1895**
 Custom Finish **\$2200**



53006 5-piece deckmount tub filler with diverter and handshower

- solid brass construction
- cascading water flow
- oak insert handshower with 5' hidden brass hose
- 1/2" connection

height: (w/ handshower) 8^{15/16"}
 overall projection: 8^{3/4"}
 flow rate: (tub filler) 11 gpm
 (handshower) 2.5 gpm

ABCA90054 / HOT
ABCA90055 / COLD

- Polished Chrome **\$1950**
 Brushed Nickel **\$2495**
 Brushed Gold **\$3395**
 Custom Finish **\$3900**



53086 cradle tub filler with handshower and floor risers

- solid brass construction
- cascading water flow
- oak insert, single-spray handshower with 5' steel braided hose
- 1/2" NPT connection

floor risers:

- solid brass construction
- 1 pair
- 3/4m x 1/2m

height: 40^{7/8"}

overall projection: 12^{7/8"}

flow rate: (tub filler) 10 gpm
(handshower) 2.5 gpm



ABCA90028 / HOT
ABCA90029 / COLD

Polished Chrome **\$2895**

Brushed Nickel **\$3750**

Brushed Gold **\$4995**

✦ Custom Finish **\$5790**



53004 wallmount cradle tub filler with handshower

- solid brass construction
- cascading water flow
- oak insert, single-spray handshower with 5' steel braided hose
- 1/2" NPT connection

height: 8^{5/8"}

overall projection: 7^{3/8"}

flow rate: (tub filler) 10 gpm (handshower) 2.5 gpm



ABCA90028 / HOT
ABCA90029 / COLD

Polished Chrome **\$1995**

Brushed Nickel **\$2595**

Brushed Gold **\$3495**

✦ Custom Finish **\$3990**



131 deckmount elbows for wallmount cradle tub filler (53004)

- solid brass construction
- 1 pair with adapters included
- available straight: 3/4m x 1/2m offset: 3/4m x 3/4m

Polished Chrome **\$250**

Brushed Nickel **\$325**

Brushed Gold **\$435**

✦ Custom Finish **\$500**



130 wallmount offset elbows for vertical installation of wallmount cradle tub filler (53004)

- solid brass construction
- 1 pair with adapters included
- available from 3^{1/2"} to 9^{1/2"} to fit thickness up to 1/2"

Polished Chrome **\$250**

Brushed Nickel **\$325**

Brushed Gold **\$435**

✦ Custom Finish **\$500**



MARMO

TOSCA

OTTO

VITTORIO

REGENCY

ETNA

CUT

OTTO

53026 4 hole lavatory bidet set

- solid brass construction
- incorporated vacuum breaker and vertical spray
- mechanical drain included
- 1/2" connection

height: 4^{11/16"}
flow rate: full flow

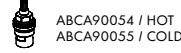

Polished Chrome	\$1350
Brushed Nickel	\$1750
Brushed Gold	\$2350
Custom Finish	\$2700



MB2

XROUND

GEO

TIME

BLOK

VOLARE

FOLIA



MIDTOWN

MUST

BLADE

LOVEME

ALPHA

METRO

CHICANE



B-JOU

MADISON

XSQUARE

STREEM

SOLO

DRAINS

Shower Valves & Trim Set Solutions

(for complete program, see pages 241 - 292)

**R3053 plate and handle trim set**

- 4^{1/4"}x7^{7/8"}x1/8"
- requires #12000 TURBO thermostatic valve with a choice of a shut-off valve (#1206) or a 2-3 way diverter (#61934)

Polished Chrome	\$245
Brushed Nickel	\$320
Brushed Gold	\$415
Custom Finish	\$490

T12000 TURBO thermostatic valve 3/4" - 1/2"

Rough	\$455
-------	--------------

**R0695 plate and handle trim set**

- 3^{1/4"}x1/8"
- requires #1206 shut-off valve

Polished Chrome	\$130
Brushed Nickel	\$165
Brushed Gold	\$225
Custom Finish	\$260

1206 TURBO 1/2" shut-off valve

Rough	\$165
-------	--------------



2-way

93921 plate and handle trim set with 2-way diverter

- **WITH STOP – shared functions**
- replaces the functionality of 2 shut-off valves
- 2^{3/4"}x1/8"
- requires #61934 diverter

Polished Chrome	\$245
Brushed Nickel	\$295
Brushed Gold	\$355
Custom Finish	\$490

61934 2 & 3 way diverter

Rough	\$195
-------	--------------



2-way

91821 plate and handle trim set with 2-way diverter

• WITH STOP – 1 function at a time

- replaces the functionality of 2 shut-off valves
- 2^{3/4}" x 1/8"
- requires #61934 diverter

- Polished Chrome **\$245**
- Brushed Nickel **\$295**
- Brushed Gold **\$355**
- Custom Finish **\$490**

61934 2 & 3 way diverter

- Rough **\$195**



3-way

93931 plate and handle trim set with 3-way diverter

• WITH STOP – shared functions

- replaces the functionality of 3 shut-off valves
- 2^{3/4}" x 1/8"
- requires #61934 diverter

- Polished Chrome **\$245**
- Brushed Nickel **\$295**
- Brushed Gold **\$355**
- Custom Finish **\$490**

61934 2 & 3 way diverter

- Rough **\$195**



3-way

93831 plate and handle trim set with 3-way diverter

• WITH STOP – 1 function at a time

- replaces the functionality of 3 shut-off valves
- 2^{3/4}" x 1/8"
- requires #61934 diverter

- Polished Chrome **\$245**
- Brushed Nickel **\$295**
- Brushed Gold **\$355**
- Custom Finish **\$490**

61934 2 & 3 way diverter

- Rough **\$195**



R3153 plate and handle trim set

- 4^{1/4}" x 1 1/8" x 1/8"
- requires #12001 TURBO thermostatic valve

- Polished Chrome **\$355**
- Brushed Nickel **\$465**
- Brushed Gold **\$620**
- Custom Finish **\$710**

T12001 TURBO thermostatic valve with 1 shut-off valve - 3/4" - 1/2"

- Rough **\$625**



R3253 plate and handle trim set

- 4^{1/4}" x 1 3/4" x 1/8"
- requires #12002 TURBO thermostatic valve

- Polished Chrome **\$470**
- Brushed Nickel **\$615**
- Brushed Gold **\$820**
- Custom Finish **\$940**

T12002 TURBO thermostatic valve with 2 shut-off valve - 3/4" - 1/2"

- Rough **\$795**



MARMO

TOSCA

OTTO

VITTORIO

REGENCY

ETNA

CUT



MB2

XROUND

GEO

TIME

BLOK

VOLARE

FOLIA



MIDTOWN

MUST

BLADE

LOVEME

ALPHA

METRO

CHICANE



B-JOU

MADISON

XSQUARE

STREEM

SOLO

OTTO

**R3353 plate and handle trim set**

- 4^{1/4"}x16^{3/4"}x1/8"
- requires # 12003 TURBO thermostatic valve

Polished Chrome **\$590**
 Brushed Nickel **\$770**
 Brushed Gold **\$1030**
 Custom Finish **\$1180**

T12003 TURBO thermostatic valve with 3 shut-off valve - 3/4" - 1/2"

Rough **\$965**

**R3453 plate and handle trim set**

- 4^{1/4"}x19^{5/8"}x1/8"
- requires # 12004 TURBO thermostatic valve

Polished Chrome **\$720**
 Brushed Nickel **\$940**
 Brushed Gold **\$1240**
 Custom Finish **\$1440**

T12004 TURBO thermostatic valve with 4 shut-off valve - 3/4" - 1/2"

Rough **\$1135**

**R8253 plate and handle trim set with 2-way diverter**

- shared functions
- 4^{1/4"}x12"x1/8"
- requires #T12123 Turbo Uniplex thermostatic valve

Polished Chrome **\$445**
 Brushed Nickel **\$580**
 Brushed Gold **\$780**
 Custom Finish **\$890**

2-way

T12123 TURBO UNIPLEX thermostatic valve 3/4" - 1/2"

Rough **\$495**

**R9253 plate and handle trim set with 2-way diverter**

- 1 function at a time
- 4^{1/4"}x12"x1/8"
- requires #T12123 Turbo Uniplex thermostatic valve

Polished Chrome **\$445**
 Brushed Nickel **\$580**
 Brushed Gold **\$780**
 Custom Finish **\$890**

2-way

T12123 TURBO UNIPLEX thermostatic valve 3/4" - 1/2"

Rough **\$495**

**R8353 plate and handle trim set with 3-way diverter**

- shared functions
- 4^{1/4"}x12"x1/8"
- requires #T12123 Turbo Uniplex thermostatic valve

Polished Chrome **\$445**
 Brushed Nickel **\$580**
 Brushed Gold **\$780**
 Custom Finish **\$890**

3-way

T12123 TURBO UNIPLEX thermostatic valve 3/4" - 1/2"

Rough **\$495**

DRAINS



3-way

- R9353 plate and handle trim set with 3-way diverter**
- 1 function at a time
 - 4^{1/4}"x12"x1/8"
 - requires #T12123 Turbo Uniplex thermostatic valve

Polished Chrome	\$445
Brushed Nickel	\$580
Brushed Gold	\$780
✦ Custom Finish	\$890

- T12123 TURBO UNIPLEX thermostatic valve 3/4" - 1/2"**

Rough	\$495
-------	--------------



- R4095 plate and handle trim set**
- 8"x1/8"
 - requires #40255 pressure balance valve

Polished Chrome	\$135
Brushed Nickel	\$175
Brushed Gold	\$235
✦ Custom Finish	\$270

- 40255 1/2" pressure balance valve for shower**
- due to visible rough parts, select matching finish

Polished Chrome	\$235
Brushed Nickel	\$265
Brushed Gold	\$415
✦ Custom Finish	\$470



- R4295 plate and handle trim set**
- 8"x1/8"
 - requires #42355 pressure balance valve

Polished Chrome	\$165
Brushed Nickel	\$215
Brushed Gold	\$290
✦ Custom Finish	\$330

- 42355 1/2" pressure balance valve for tub / shower**
- due to visible rough parts, select matching finish

Polished Chrome	\$425
Brushed Nickel	\$485
Brushed Gold	\$745
✦ Custom Finish	\$850

VITTORIO

AVAILABLE FINISHES

polished chrome



brushed gold



VITTORIO collection is also available
in Aquabross' custom finishes
(10 weeks lead time, see finish chart p.vii)





MARMO

TOSCA

OTTO

VITTORIO

REGENCY

ETNA

CUT



MB2

XROUND

GEO

TIME

BLOK

VOLARE

FOLIA



MIDTOWN

MUST

BLADE

LOVEME

ALPHA

METRO

CHICANE



B-JOU

MADISON

XSQUARE

STREEM

SOLO

VITTORIO

AVAILABLE Q1 2020



83516 widespread lavatory faucet

- solid brass construction
- crystal clear water flow
- mechanical drain included
- swiveling aerator (7.5 degree rotation) to redirect flow
- 3/8" connection

height: 10^{1/2}"overall projection: 6^{5/16}"

flow rate: 1.75 gpm

ABCA30911 / HOT
ABCA30921 / COLD

Polished Chrome

\$795

Brushed Gold

\$1395

Custom Finish

\$1590

83529 wallmount 8" c.c. lavatory faucet

- solid brass construction
- crystal clear water flow
- drain not included, see page 212 for options
- rough-in not included, order #83029

height: 3^{3/4}"overall projection: 10^{5/16}"

flow rate: 2.2 gpm

ABCA82411 / HOT
ABCA82421 / COLD

Polished Chrome

\$795

Brushed Gold

\$1395

Custom Finish

\$1590

83029 rough-in for wallmount faucet #83529

- 1/2" NPT connection

Rough-in

\$195

83518 4-piece deckmount tub filler with handshower

- solid brass construction
- crystal clear water flow
- handshower with 5' double-helix hidden hose
- 1/2" connection

height: 11^{7/8}"

overall projection: 8"

flow rate: (tub filler) 8 gpm
(handshower) 2.5 gpmABCA30911 / HOT
ABCA30921 / COLD

Polished Chrome

\$1295

Brushed Gold

\$2265

Custom Finish

\$2590

83526 4 hole bidet set

- solid brass construction
- incorporated vacuum breaker & vertical spray
- mechanical drain included
- 1/2" connection

height: 4^{11/16}"

flow rate: full flow

ABCA30911 / HOT
ABCA30921 / COLD

Polished Chrome

\$1350

Brushed Gold

\$2350

Custom Finish

\$2700

Shower Valves & Trim Set Solutions

(for complete program, see pages 241 - 292)



2-way

C8283 plate and handle trim set with 2-way diverter
 - shared functions
 • 4^{1/4}"x12"x1/8"
 • requires #T12123 Turbo Uniplex thermostatic valve

Polished Chrome **\$795**
 Brushed Gold **\$1395**
 Custom Finish **\$1590**

T12123 TURBO UNIPLEX thermostatic valve 3/4" - 1/2"

Rough **\$495**



2-way

C9283 plate and handle trim set with 2-way diverter
 - 1 function at a time
 • 4^{1/4}"x12"x1/8"
 • requires #T12123 Turbo Uniplex thermostatic valve

Polished Chrome **\$795**
 Brushed Gold **\$1395**
 Custom Finish **\$1590**

T12123 TURBO UNIPLEX thermostatic valve 3/4" - 1/2"

Rough **\$495**



3-way

C8383 plate and handle trim set with 3-way diverter
 - shared functions
 • 4^{1/4}"x12"x1/8"
 • requires #T12123 Turbo Uniplex thermostatic valve

Polished Chrome **\$795**
 Brushed Gold **\$1395**
 Custom Finish **\$1590**

T12123 TURBO UNIPLEX thermostatic valve 3/4" - 1/2"

Rough **\$495**



3-way

C9383 plate and handle trim set with 3-way diverter
 - 1 function at a time
 • 4^{1/4}"x12"x1/8"
 • requires #T12123 Turbo Uniplex thermostatic valve

Polished Chrome **\$795**
 Brushed Gold **\$1395**
 Custom Finish **\$1590**

T12123 TURBO UNIPLEX thermostatic valve 3/4" - 1/2"

Rough **\$495**

REGENCY

AVAILABLE FINISHES

polished chrome



brushed nickel



electro black



brushed gold



 REGENCY collection is also available
in Aquabross' custom finishes
(10 weeks lead time, see finish chart p.vii)

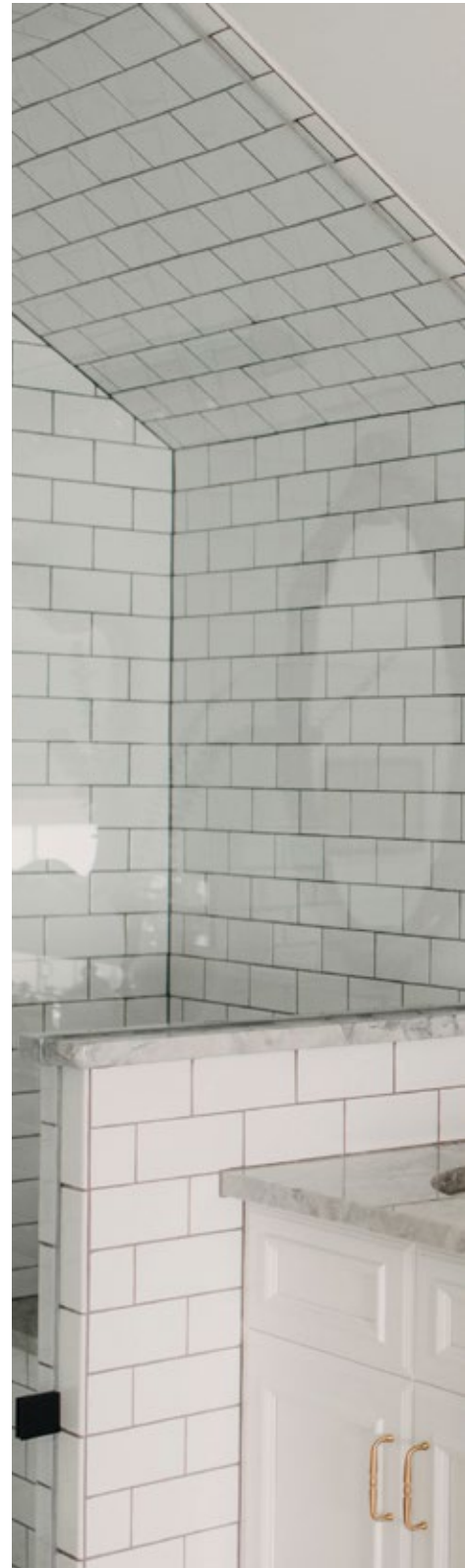

Photo credit: Justine Alyssa, Edmonton, Alberta
faucets #7316 featured in brushed gold





MARMO

TOSCA

OTTO

VITTORIO

REGENCY

ETNA

CUT



MB2

XROUND

GEO

TIME

BLOK

VOLARE

FOLIA



MIDTOWN

MUST

BLADE

LOVEME

ALPHA

METRO

CHICANE



B-JOU

MADISON

XSQUARE

STREEM

SOLO

DRAINS

REGENCY



7316 widespread lavatory faucet

- solid brass construction
- crystal clear water flow
- optional raised flange for spout included
- mechanical drain included
- 1/2" connection

height: 3^{1/2}"
 overall projection: 6^{9/16}"
 flow rate: 2.2 gpm

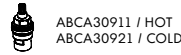

ABCA30911 / HOT
 ABCA30921 / COLD

- Polished Chrome **\$595**
- Brushed Nickel **\$775**
- Electro Black **\$995**
- Brushed Gold **\$995**
- Custom Finish **\$1190**



7318 4-piece deckmount tub filler with handshower

- solid brass construction
- crystal clear water flow
- handshower with 5' double-helix hidden hose
- 1/2" connection

height: (w/ handshower) 8^{1/4}"
 overall projection: 10^{5/8}"
 flow rate: (tub filler) 11 gpm
 (handshower) 2.5 gpm

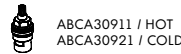

ABCA30911 / HOT
 ABCA30921 / COLD

- Polished Chrome **\$795**
- Brushed Nickel **\$995**
- Electro Black **\$1295**
- Brushed Gold **\$1295**
- Custom Finish **\$1590**



N7329 wallmount 8" c.c. lavatory faucet

- solid brass construction
- crystal clear water flow
- drain not included, see page 212 for options
- rough-in not included, order #83029

height: 3^{1/8}"
 overall projection: 9^{1/2}"
 flow rate: 2.2 gpm

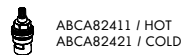

ABCA82411 / HOT
 ABCA82421 / COLD

- Polished Chrome **\$645**
- Brushed Nickel **\$835**
- Electro Black **\$1125**
- Brushed Gold **\$1125**
- Custom Finish **\$1290**



83029 rough-in for wallmount faucet #N7329

- 1/2" NPT connection

Rough-in **\$195**



7304 wallmount cradle tub filler with handshower

- solid brass construction
- cascading water flow
- handshower with 5' brass hose
- 3/4" NPT female connection

height: 10^{7/8}"
 overall projection: 6"
 flow rate: (tub filler) 10 gpm
 (handshower) 2.5 gpm

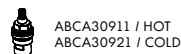

ABCA30911 / HOT
 ABCA30921 / COLD

- Polished Chrome **\$795**
- Brushed Nickel **\$1050**
- Electro Black **\$1395**
- Brushed Gold **\$1395**
- Custom Finish **\$1590**

131 deckmount elbows for wallmount cradle tub filler (7304)



- solid brass construction
- 1 pair with adapters included
- available straight: 3/4m x 1/2m

Polished Chrome	\$250
Brushed Nickel	\$325
Electro Black	\$435
Brushed Gold	\$435
Custom Finish	\$500

130 wallmount offset elbows for vertical installation of wallmount cradle tub filler (7304)



- solid brass construction
- 1 pair with adapters included
- available from 3 1/2" to 9 1/2" to fit thickness up to 1/2"

Polished Chrome	\$250
Brushed Nickel	\$325
Electro Black	\$435
Brushed Gold	\$435
Custom Finish	\$500

7386 cradle tub filler with handshower and floor risers



- solid brass construction
- cascading water flow
- handshower with 5' brass hose
- 3/4" NPT female connection

Polished Chrome	\$1595
Brushed Nickel	\$1995
Electro Black	\$2795
Brushed Gold	\$2795
Custom Finish	\$3190

floor risers:

- solid brass construction
- 1 pair
- 3/4m x 1/2m

height: 32 3/8"

overall projection: 10 1/4"

flow rate: (tub filler) 10 gpm
(handshower) 2.5 gpm



ABCA30911 / HOT
ABCA30921 / COLD

7326 4 hole lavatory bidet set



- solid brass construction
- incorporated vacuum breaker and vertical spray
- mechanical drain included
- 1/2" connection

Polished Chrome	\$1350
Brushed Nickel	\$1750
Electro Black	\$2350
Brushed Gold	\$2350
Custom Finish	\$2700

height: 4 11/16"

flow rate: full flow



ABCA30911 / HOT
ABCA30921 / COLD



MARMO

TOSCA

OTTO

VITTORIO

REGENCY

ETNA

CUT



MB2

XROUND

GEO

TIME

BLOK

VOLARE

FOLIA



MIDTOWN

MUST

BLADE

LOVEME

ALPHA

METRO

CHICANE



B-JOU

MADISON

XSQUARE

STREEM

SOLO

REGENCY

Shower Valves & Trim Set Solutions

(for complete program, see pages 241 - 292)

AVAILABLE Q1 2020



2-way

C8273 plate and handle trim set with 2-way diverter

• shared functions

- 4^{1/4}"x12"x1/8"
- requires #T12123 Turbo Uniplex thermostatic valve

Polished Chrome **\$795**
 Brushed Nickel **\$1035**
 Electro Black **\$1395**
 Brushed Gold **\$1395**

Custom Finish **\$1590**

T12123 TURBO UNIPLEX thermostatic valve 3/4" - 1/2"

Rough **\$495**



2-way

C9273 plate and handle trim set with 2-way diverter

• 1 function at a time

- 4^{1/4}"x12"x1/8"
- requires #T12123 Turbo Uniplex thermostatic valve

Polished Chrome **\$795**
 Brushed Nickel **\$1035**
 Electro Black **\$1395**
 Brushed Gold **\$1395**

Custom Finish **\$1590**

T12123 TURBO UNIPLEX thermostatic valve 3/4" - 1/2"

Rough **\$495**



3-way

C8373 plate and handle trim set with 3-way diverter

• shared functions

- 4^{1/4}"x12"x1/8"
- requires #T12123 Turbo Uniplex thermostatic valve

Polished Chrome **\$795**
 Brushed Nickel **\$1035**
 Electro Black **\$1395**
 Brushed Gold **\$1395**

Custom Finish **\$1590**

T12123 TURBO UNIPLEX thermostatic valve 3/4" - 1/2"

Rough **\$495**



3-way

C9373 plate and handle trim set with 3-way diverter

• 1 function at a time

- 4^{1/4}"x12"x1/8"
- requires #T12123 Turbo Uniplex thermostatic valve

Polished Chrome **\$795**
 Brushed Nickel **\$1035**
 Electro Black **\$1395**
 Brushed Gold **\$1395**

Custom Finish **\$1590**

T12123 TURBO UNIPLEX thermostatic valve 3/4" - 1/2"

Rough **\$495**



MARMO

TOSCA

OTTO

VITTORIO

REGENCY

ETNA

CUT



MB2

XROUND

GEO

TIME

BLOK

VOLARE

FOLIA



MIDTOWN

MUST

BLADE

LOVEME

ALPHA

METRO

CHICANE



B-JOU

MADISON

X SQUARE

STREEM

SOLO

DRAINS

ETNA

AVAILABLE FINISHES

polished chrome



brushed nickel



CHOICE OF SPOUTS



ETNA
metal

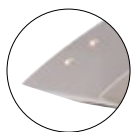

ETNA STAR
Swarovski crystal

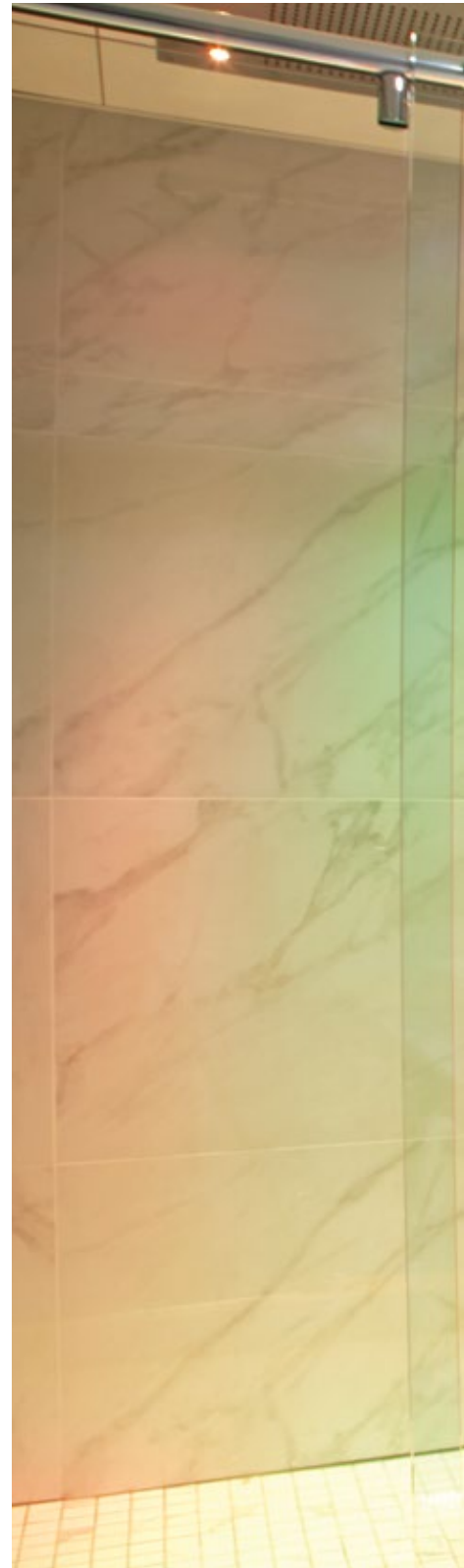





MARMO

TOSCA

OTTO

VITTORIO

REGENCY

ETNA

CUT



MB2

XROUND

GEO

TIME

BLOK

VOLARE

FOLIA



MIDTOWN

MUST

BLADE

LOVEME

ALPHA

METRO

CHICANE



B-JOU

MADISON

XSQUARE

STREEM

SOLO

DRAINS

ETNA



61614 single-hole lavatory faucet

- solid brass construction
- recessed aerator – aerated water flow
- single volume and temperature joystick control
- press pop-up drain with overflow included
- 3/8" connection

height: 7^{1/4}"overall projection: 6^{7/16}"

flow rate: 1.5 gpm



ABCA61N98

Polished Chrome

\$795

Brushed Nickel

\$1050

61620 tall single-hole lavatory faucet

- solid brass construction
- recessed aerator – aerated water flow
- single volume and temperature joystick control
- press pop-up drain with overflow included
- 3/8" connection

height: 11"

overall projection: 7^{3/8}"

flow rate: 1.5 gpm



ABCA61N98

Polished Chrome

\$995

Brushed Nickel

\$1295

61616 widespread lavatory faucet

- solid brass construction
- recessed aerator – aerated water flow
- press pop-up drain with overflow included
- 1/2" connection

height: 7^{1/4}"overall projection: 5^{3/4}"

flow rate: 1.5 gpm

ABCA39597 / HOT
ABCA39596 / COLD

Polished Chrome

\$1395

Brushed Nickel

\$1795

616N85 floormount tub filler with handshower

- solid brass construction
- recessed aerator – aerated water flow
- 2 independent mixing valves
- handshower with 5' reinforced PVC hose
- rough-in not included, order #92189
- 1/2" connection

height: 34"

overall projection: 11"

flow rate: (tub filler) 5 gpm
(handshower) 1.5 gpm

ABCA39598

Polished Chrome

\$2995

Brushed Nickel

\$3895

92189 rough-in for wallmount tub filler 616N85

- 1/2" NPT male connection

Rough-in

\$595

ETNA STAR



MARMO

TOSCA

OTTO

VITTORIO

REGENCY

ETNA

CUT



MB2

XROUND

GEO

TIME

BLOK

VOLARE

FOLIA



MIDTOWN

MUST

BLADE

LOVEME

ALPHA

METRO

CHICANE



B-JOU

MADISON

X SQUARE

STREEM

SOLO

DRAINS

61714 single-hole lavatory faucet WITH CRYSTALS



- solid brass construction
- recessed aerator – aerated water flow
- single volume and temperature joystick control
- press pop-up drain with overflow included
- 3/8" connection

height: 7^{1/4}"

overall projection: 6^{7/16}"

flow rate: 1.5 gpm



ABCA61N98

Polished Chrome **\$1195**

Brushed Nickel **\$1550**

61720 tall single-hole lavatory faucet WITH CRYSTALS



- solid brass construction
- recessed aerator – aerated water flow
- single volume and temperature joystick control
- press pop-up drain with overflow included
- 3/8" connection

height: 11"

overall projection: 7^{3/8}"

flow rate: 1.5 gpm



ABCA61N98

Polished Chrome **\$1395**

Brushed Nickel **\$1795**

61716 widespread lavatory faucet WITH CRYSTALS



- solid brass construction
- recessed aerator – aerated water flow
- press pop-up drain with overflow included
- 1/2" connection

height: 7^{1/4}"

overall projection: 5^{3/4}"

flow rate: 1.5 gpm



ABCA39597 / HOT
ABCA39596 / COLD

Polished Chrome **\$1795**

Brushed Nickel **\$2350**

617N85 floormount tub filler with handshower WITH CRYSTALS



- solid brass construction
- recessed aerator – aerated water flow
- 2 independent mixing valves
- handshower with 5' reinforced PVC hose
- rough-in not included, order #92189
- 1/2" connection

height: 34"

overall projection: 11"

flow rate: (tub filler) 5 gpm
(handshower) 1.5 gpm



ABCA39598

Polished Chrome **\$3295**

Brushed Nickel **\$4295**

92189 rough-in for wallmount tub filler 617N85



- 1/2" NPT male connection

Rough-in **\$595**



MARMO

TOSCA

OTTO

VITTORIO

REGENCY

ETNA

CUT



MB2

XROUND

GEO

TIME

BLOK

VOLARE

FOLIA



MIDTOWN

MUST

BLADE

LOVEME

ALPHA

METRO

CHICANE



B-JOU

MADISON

XSQUARE

STREEM

SOLO

DRAINS

ETNA

Shower Valves & Trim Set Solutions

(for complete program, see pages 241 - 292)

**SR3095 plate and handle trim set**

- 4^{1/4"}x7^{7/8"}x1/8"
- requires # 12000 TURBO thermostatic valve with a choice of a shut-off valve (# 1206) or a 2-3 way diverter (# 61934)

Polished Chrome

\$195

Brushed Nickel

\$255**T12000 TURBO thermostatic valve 3/4" - 1/2"**

Rough

\$455**SR0695 plate and handle trim set**

- 3^{1/4"}x4^{1/4"}x1/8"
- requires # 1206 shut-off valve

Polished Chrome

\$160

Brushed Nickel

\$205**1206 1/2" shut-off valve**

Rough

\$165

2-way

93922 plate and handle trim set with 2-way diverter

- **WITH STOP – shared functions**
- replaces the functionality of 2 shut-off valves
- 2^{3/4"}x2^{3/4"}x1/8"
- requires # 61934 diverter

Polished Chrome

\$275

Brushed Nickel

\$325**61934 2 & 3 way diverter**

Rough

\$195

2-way

93822 plate and handle trim set with 2-way diverter

- **WITH STOP – 1 function at a time**
- replaces the functionality of 2 shut-off valves
- 2^{3/4"}x2^{3/4"}x1/8"
- requires # 61934 diverter

Polished Chrome

\$275

Brushed Nickel

\$325**61934 2 & 3 way diverter**

Rough

\$195



3-way

93932 plate and handle trim set with 3-way diverter
• WITH STOP – shared functions

- replaces the functionality of 3 shut-off valves
- 2^{3/4}" x 2^{3/4}" x 1/8"
- requires # 61934 diverter

 Polished Chrome **\$275**

 Brushed Nickel **\$325**
61934 2 & 3 way diverter

 Rough **\$195**

3-way

93832 plate and handle trim set with 3-way diverter
• WITH STOP – 1 function at a time

- replaces the functionality of 3 shut-off valves
- 2^{3/4}" x 2^{3/4}" x 1/8"
- requires # 61934 diverter

 Polished Chrome **\$275**

 Brushed Nickel **\$325**
61934 2 & 3 way diverter

 Rough **\$195**

SR3195 plate and handle trim set

- 4^{1/4}" x 11" x 1/8"
- requires # 12001 TURBO thermostatic valve

 Polished Chrome **\$340**

 Brushed Nickel **\$445**
T12001 TURBO thermostatic valve with 1 shut-off valve - 3/4" - 1/2"

 Rough **\$625**

SR3295 plate and handle trim set

- 4^{1/4}" x 13^{3/4}" x 1/8"
- requires # 12002 TURBO thermostatic valve

 Polished Chrome **\$490**

 Brushed Nickel **\$640**
T12002 TURBO thermostatic valve with 2 shut-off valve - 3/4" - 1/2"

 Rough **\$795**

SR3395 plate and handle trim set

- 4^{1/4}" x 16^{3/4}" x 1/8"
- requires # 12003 TURBO thermostatic valve

 Polished Chrome **\$645**

 Brushed Nickel **\$840**
T12003 TURBO thermostatic valve with 3 shut-off valve - 3/4" - 1/2"

 Rough **\$965**



MARMO

TOSCA

OTTO

VITTORIO

REGENCY

ETNA

CUT



MB2

XROUND

GEO

TIME

BLOK

VOLARE

FOLIA



MIDTOWN

MUST

BLADE

LOVEME

ALPHA

METRO

CHICANE



B-JOU

MADISON

XSQUARE

STREEM

SOLO

ETNA

**SR3495 plate and handle trim set**

- 4^{1/4"}x12^{5/8"}x1/8"
- requires #12004 TURBO thermostatic valve

Polished Chrome

\$795

Brushed Nickel

\$1050**T12004 TURBO thermostatic valve with 4 shut-off valve - 3/4" - 1/2"**

Rough

\$1135

2-way

SR8295 plate and handle trim set with 2-way diverter

- shared functions
- 4^{1/4"}x12"x1/8"
- requires #T12123 Turbo Uniplex thermostatic valve

Polished Chrome

\$455

Brushed Nickel

\$590**T12123 TURBO UNIPLEX thermostatic valve 3/4" - 1/2"**

Rough

\$495

2-way

SR9295 plate and handle trim set with 2-way diverter

- 1 function at a time
- 4^{1/4"}x12"x1/8"
- requires #T12123 Turbo Uniplex thermostatic valve

Polished Chrome

\$455

Brushed Nickel

\$590**T12123 TURBO UNIPLEX thermostatic valve 3/4" - 1/2"**

Rough

\$495

3-way

SR8395 plate and handle trim set with 3-way diverter

- shared functions
- 4^{1/4"}x12"x1/8"
- requires #T12123 Turbo Uniplex thermostatic valve

Polished Chrome

\$455

Brushed Nickel

\$590**T12123 TURBO UNIPLEX thermostatic valve 3/4" - 1/2"**

Rough

\$495

3-way

SR9395 plate and handle trim set with 3-way diverter

- 1 function at a time
- 4^{1/4"}x12"x1/8"
- requires #T12123 Turbo Uniplex thermostatic valve

Polished Chrome

\$455

Brushed Nickel

\$590**T12123 TURBO UNIPLEX thermostatic valve 3/4" - 1/2"**

Rough

\$495



SR4095 plate and handle trim set

- 6^{1/2}"x8^{1/4}"x1/8"
- requires #40255 pressure balance valve

Polished Chrome **\$165**
Brushed Nickel **\$215**

40255 1/2" pressure balance valve for shower

- due to visible rough parts, select matching finish

Polished Chrome **\$235**
Brushed Nickel **\$265**



SR4295 plate and handle trim set

- 6^{1/2}"x8^{1/4}"x1/8"
- requires #42355 pressure balance valve

Polished Chrome **\$195**
Brushed Nickel **\$250**

42355 1/2" pressure balance valve for tub / shower

- due to visible rough parts, select matching finish

Polished Chrome **\$425**
Brushed Nickel **\$485**

CUT

AVAILABLE FINISHES

polished chrome



CUT collection is also available
in Aquabross' custom finishes
(10 weeks lead time, see finish chart p.vii)







MARMO

TOSCA

OTTO

VITTORIO

REGENCY

ETNA

CUT



MB2

XROUND

GEO

TIME

BLOK

VOLARE

FOLIA



MIDTOWN

MUST

BLADE

LOVEME

ALPHA

METRO

CHICANE



B-JOU

MADISON

XSQUARE

STREEM

SOLO

DRAINS

CUT



39544 short single-hole lavatory faucet

Polished Chrome

\$1050

- solid brass construction
- aerated water flow
- single volume and temperature joystick control
- press pop-up drain with overflow included
- 3/8" connection

Custom Finish

\$2100height: 7^{1/8"}overall projection: 6^{7/8"}

flow rate: 2.2 gpm



ABCA39599



39514 single-hole lavatory faucet

Polished Chrome

\$1150

- solid brass construction
- aerated water flow
- single volume and temperature joystick control
- press pop-up drain with overflow included
- 3/8" connection

Custom Finish

\$2300height: 10^{3/8"}overall projection: 7^{7/8"}

flow rate: 2.2 gpm



ABCA39599



39520 tall single-hole lavatory faucet

Polished Chrome

\$1250

- solid brass construction
- aerated water flow
- single volume and temperature joystick control
- press pop-up drain with overflow included
- 3/8" connection

Custom Finish

\$2500height: 13^{7/8"}overall projection: 7^{7/8"}

flow rate: 2.2 gpm



ABCA39599



39529 wallmount lavatory faucet

Polished Chrome

\$1050

- rough-in included
- solid brass construction
- aerated water flow
- drain not included, see page 212 for options
- 1/2" NPT female connection

Custom Finish

\$2100height: (w/ plate) 4^{5/16"}overall projection: 8^{5/8"}

flow rate: 2.2 gpm



ABCA39598



39516 widespread lavatory faucet

Polished Chrome

\$1295



- solid brass construction
- aerated water flow
- press pop-up drain with overflow included
- 1/2" connection



Custom Finish

\$2590height: 8^{1/4"}overall projection: 9^{1/4"}

flow rate: 2.2 gpm

ABCA39597 / HOT
ABCA39596 / COLD

	<p>39518 4-piece deckmount tub filler with handshower</p> <ul style="list-style-type: none"> ▪ solid brass construction ▪ aerated water flow ▪ handshower with 5' double-helix hidden hose ▪ 1/2" connection <p>height: 11^{7/8}" overall projection: 8" flow rate: (tub filler) 8 gpm (handshower) 2.5 gpm</p>	<p>Polished Chrome \$2195</p> <p>✦ Custom Finish \$4390</p>
		 <p>ABCA39597 / HOT ABCA39596 / COLD</p>

	<p>39526 4 hole bidet set</p> <ul style="list-style-type: none"> ▪ solid brass construction ▪ incorporated vacuum breaker & vertical spray ▪ 1/2" connection <p>height: 4^{11/16}" flow rate: full flow</p>	<p>Polished Chrome \$1350</p> <p>✦ Custom Finish \$2700</p>
		 <p>ABCA30911 / HOT ABCA30921 / COLD</p>

Shower Valves & Trim Set Solutions

(for complete program, see pages 241 - 292)

	<p>R3095 plate and handle trim set</p> <ul style="list-style-type: none"> ▪ 4^{1/4}"x7^{7/8}"x1/8" ▪ requires # 12000 TURBO thermostatic valve with a choice of a shut-off valve (# 1206) or a 2-3 way diverter (# 61934) 	<p>Polished Chrome \$150</p> <p>✦ Custom Finish \$300</p>
		<p>T12000 TURBO thermostatic valve 3/4" - 1/2"</p> <p>Rough \$455</p>

	<p>R0695 plate and handle trim set</p> <ul style="list-style-type: none"> ▪ 3^{1/4}"x1/8" ▪ requires # 1206 shut-off valve 	<p>Polished Chrome \$130</p> <p>✦ Custom Finish \$260</p>
		<p>1206 TURBO 1/2" shut-off valve</p> <p>Rough \$165</p>



MARMO

TOSCA

OTTO

VITTORIO

REGENCY

ETNA

CUT

CUT



2-way

93921 plate and handle trim set with 2-way diverter**• WITH STOP – shared functions**

- replaces the functionality of 2 shut-off valves
- 2^{3/4}" x 1/8"
- requires # 61934 diverter

Polished Chrome

\$245

Custom Finish

\$490**61934 2 & 3 way diverter**

Rough

\$195

2-way

93821 plate and handle trim set with 2-way diverter**• WITH STOP – 1 function at a time**

- replaces the functionality of 2 shut-off valves
- 2^{3/4}" x 1/8"
- requires # 61934 diverter

Polished Chrome

\$245

Custom Finish

\$490**61934 2 & 3 way diverter**

Rough

\$195

3-way

93931 plate and handle trim set with 3-way diverter**• WITH STOP – shared functions**

- replaces the functionality of 3 shut-off valves
- 2^{3/4}" x 1/8"
- requires # 61934 diverter

Polished Chrome

\$245

Custom Finish

\$490**61934 2 & 3 way diverter**

Rough

\$195

3-way

93831 plate and handle trim set with 3-way diverter**• WITH STOP – 1 function at a time**

- replaces the functionality of 3 shut-off valves
- 2^{3/4}" x 1/8"
- requires # 61934 diverter

Polished Chrome

\$245

Custom Finish

\$490**61934 2 & 3 way diverter**

Rough

\$195**R3195 plate and handle trim set**

- 4^{1/4}" x 11" x 1/8"

- requires # 12001 TURBO thermostatic valve

Polished Chrome

\$260

Custom Finish

\$520**T12001 TURBO thermostatic valve with 1 shut-off valve - 3/4" - 1/2"**

Rough

\$625

SOLO

DRAINS

MIDTOWN

MUST

BLADE

LOVEME

ALPHA

METRO

CHICANE



B-JOU

MADISON

XSQUARE

STREEM



R3295 plate and handle trim set
 • 4^{1/4}"x13^{3/4}"x1/8"
 • requires # 12002 TURBO thermostatic valve

Polished Chrome **\$375**
 Custom Finish **\$750**

T12002 TURBO thermostatic valve with 2 shut-off valve - 3/4" - 1/2"

Rough **\$795**



R3395 plate and handle trim set
 • 4^{1/4}"x16^{3/4}"x1/8"
 • requires # 12003 TURBO thermostatic valve

Polished Chrome **\$495**
 Custom Finish **\$990**

T12003 TURBO thermostatic valve with 3 shut-off valve - 3/4" - 1/2"

Rough **\$965**



R3495 plate and handle trim set
 • 4^{1/4}"x19^{5/8}"x1/8"
 • requires # 12004 TURBO thermostatic valve

Polished Chrome **\$625**
 Custom Finish **\$1250**

T12004 TURBO thermostatic valve with 4 shut-off valve - 3/4" - 1/2"

Rough **\$1135**



R8295 plate and handle trim set with 2-way diverter
 • shared functions
 • 4^{1/4}"x12"x1/8"
 • requires # T12123 Turbo Uniplex thermostatic valve

Polished Chrome **\$350**
 Custom Finish **\$700**

T12123 TURBO UNIPLEX thermostatic valve 3/4" - 1/2"

Rough **\$495**

2-way



R9295 plate and handle trim set with 2-way diverter
 • 1 function at a time
 • 4^{1/4}"x12"x1/8"
 • requires # T12123 Turbo Uniplex thermostatic valve

Polished Chrome **\$350**
 Custom Finish **\$700**

T12123 TURBO UNIPLEX thermostatic valve 3/4" - 1/2"

Rough **\$495**

2-way



MARMO

TOSCA

OTTO

VITTORIO

REGENCY

ETNA

CUT

CUT



3-way

R8395 plate and handle trim set with 3-way diverter**• shared functions**

- 4^{1/4}"x12"x1/8"
- requires #T12123 Turbo Uniplex thermostatic valve

Polished Chrome

\$350

✦ Custom Finish

\$700**T12123 TURBO UNIPLEX thermostatic valve 3/4" - 1/2"**

Rough

\$495

3-way

R9395 plate and handle trim set with 3-way diverter**• 1 function at a time**

- 4^{1/4}"x12"x1/8"
- requires #T12123 Turbo Uniplex thermostatic valve

Polished Chrome

\$350

✦ Custom Finish

\$700**T12123 TURBO UNIPLEX thermostatic valve 3/4" - 1/2"**

Rough

\$495

MB2

XROUND

GEO

TIME

BLOK

VOLARE

FOLIA

**R4095 plate and handle trim set**

- 8"x1/8"
- requires #40255 pressure balance valve

Polished Chrome

\$135

✦ Custom Finish

\$270**40255 1/2" pressure balance valve for shower**

- due to visible rough parts, select matching finish

Polished Chrome

\$235

✦ Custom Finish

\$470

MIDTOWN

MUST

BLADE

LOVEME

ALPHA

METRO

CHICANE

**R4295 plate and handle trim set**

- 8"x1/8"
- requires #42355 pressure balance valve

Polished Chrome

\$165

✦ Custom Finish

\$330**42355 1/2" pressure balance valve for tub / shower**

- due to visible rough parts, select matching finish

Polished Chrome

\$425

✦ Custom Finish

\$850

B-JOU

MADISON

XSQUARE

STREEM

SOLO

DRAINS



MARMO

TOSCA

OTTO

VITTORIO

REGENCY

ETNA

CUT



MB2

XROUND

GEO

TIME

BLOK

VOLARE

FOLIA



MIDTOWN

MUST

BLADE

LOVEME

ALPHA

METRO

CHICANE



B-JOU

MADISON

X SQUARE

STREEM

SOLO

DRAINS

MB2

AVAILABLE FINISHES

polished chrome



brushed gold

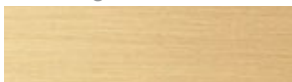

MB2 collection is also available
in Aquabrand's custom finishes
(10 weeks lead time, see finish chart p.vii)

2 HANDLE **INSERTS** INCLUDED WITH EACH MB2 FAUCET



smooth



knurled





MARMO

TOSCA

OTTO

VITTORIO

REGENCY

ETNA

CUT



MB2

XROUND

GEO

TIME

BLOK

VOLARE

FOLIA



MIDTOWN

MUST

BLADE

LOVEME

ALPHA

METRO

CHICANE



B-JOU

MADISON

XSQUARE

STREEM

SOLO

MB2



MB214 single-hole lavatory faucet

- solid brass construction
- **2 handle inserts included – smooth and knurled**
- crystal clear water flow
- press pop-up drain with overflow included
- 3/8" connection

height: 7^{1/2}"overall projection: 5^{9/16}"

flow rate: 1.75 gpm



ABCAMB201

- Polished Chrome **\$575**
- Brushed Gold **\$795**
- Custom Finish **\$1150**



MB220 tall single-hole lavatory faucet

- solid brass construction
- **2 handle inserts included – smooth and knurled**
- crystal clear water flow
- press pop-up drain with overflow included
- 3/8" connection

height: 11^{11/16}"overall projection: 6^{5/8}"

flow rate: 1.75 gpm



ABCAMB201

- Polished Chrome **\$875**
- Brushed Gold **\$1225**
- Custom Finish **\$1750**



MB210 widespread lavatory faucet

- solid brass construction
- **2 pairs of handle inserts included – smooth and knurled**
- crystal clear water flow
- mechanical drain included
- 1/2" connection

height: 2^{3/4}"overall projection: 6^{5/8}"

flow rate: 1.75 gpm

ABC30911 / HOT
ABCA30921 / COLD

- Polished Chrome **\$795**
- Brushed Gold **\$1115**
- Custom Finish **\$1590**



MB229 wallmount lavatory faucet

- solid brass construction
- **2 handle inserts included – smooth and knurled**
- crystal clear water flow
- drain not included, see page 212 for options
- rough-in not included, order # **CB029**

height: (w/ plate) 3^{15/16}"overall projection: 10^{5/16}"

flow rate: 2 gpm



ABCAMB203



ABSPEX2206 (PC & BGD)

- Polished Chrome **\$645**
- Brushed Gold **\$905**
- Custom Finish **\$1290**

CB029 rough-in for wallmount faucet #MB229

- 1/2" NPT connection

Rough-in **\$295**



MB284 floormount tub filler with handshower

- solid brass construction
- **2 handle inserts included – smooth and knurled**
- crystal clear water flow
- microphone handshower with 5' brass hose
- pull-button diverter on side of spout
- 1/2" connection

height: 35^{7/8"}

overall projection: 11^{7/16"}

flow rate (tub filler): 4.5 gpm
(handshower): 2.5 gpm



- Polished Chrome **\$2425**
- Brushed Gold **\$3395**
- ✦ Custom Finish **\$4850**

Easy-Fit™ adaptors included for an easy, fast and simple installation (see installation guide for details)

Easy-Fit™ adaptors give extra play room and snap when faucet is pushed down

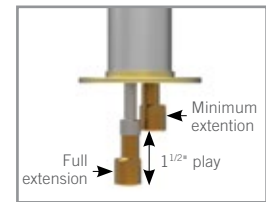

MB224 single-hole bidet with swivel spray

- solid brass construction
- **2 handle inserts included – smooth and knurled**
- press pop-up drain with overflow included
- 3/8" connection

height: 6"

overall projection: 5^{1/2"} with 20° swivel aerator

flow rate: 3 gpm

- Polished Chrome **\$695**
- Brushed Gold **\$895**
- ✦ Custom Finish **\$1390**





MARMO

TOSCA

OTTO

VITTORIO

REGENCY

ETNA

CUT

MB2



MB2

XROUND

GEO

TIME

BLOK

VOLARE

FOLIA



MIDTOWN

MUST

BLADE

LOVEME

ALPHA

METRO

CHICANE



B-JOU

MADISON

XSQUARE

STREEM

SOLO

Shower Valves & Trim Set Solutions

(for complete program, see pages 241 - 292)



R3095 plate and handle trim set

- 4^{1/4}"x7^{7/8}"x1/8"
- requires #12000 TURBO thermostatic valve with a choice of a shut-off valve (#1206) or a 2-3 way diverter (#61934)

Polished Chrome **\$150**
 Brushed Gold **\$250**
 Custom Finish **\$300**

T12000 TURBO thermostatic valve 3/4" - 1/2"

Rough **\$455**



R0695 plate and handle trim set

- 3^{1/4}"x1/8"
- requires #1206 shut-off valve

Polished Chrome **\$130**
 Brushed Gold **\$235**
 Custom Finish **\$260**

1206 TURBO 1/2" shut-off valve

Rough **\$165**



2-way

93921 plate and handle trim set with 2-way diverter

- **WITH STOP - shared functions**
- replaces the functionality of 2 shut-off valves
- 2^{3/4}" x1/8"
- requires #61934 diverter

Polished Chrome **\$245**
 Brushed Gold **\$355**
 Custom Finish **\$490**

61934 2 & 3 way diverter

Rough **\$195**



2-way

93821 plate and handle trim set with 2-way diverter

- **WITH STOP - 1 function at a time**
- replaces the functionality of 2 shut-off valves
- 2^{3/4}" x1/8"
- requires #61934 diverter

Polished Chrome **\$245**
 Brushed Gold **\$355**
 Custom Finish **\$490**

61934 2 & 3 way diverter

Rough **\$195**

DRAINS



3-way

93931 plate and handle trim set with 3-way diverter
• WITH STOP – shared functions

- replaces the functionality of 3 shut-off valves
- 2^{3/4}" x 1/8"
- requires #61934 diverter

Polished Chrome

\$245

Brushed Gold

\$355

Custom Finish

\$490
61934 2 & 3 way diverter

Rough

\$195

3-way

93831 plate and handle trim set with 3-way diverter
• WITH STOP – 1 function at a time

- replaces the functionality of 3 shut-off valves
- 2^{3/4}" x 1/8"
- requires #61934 diverter

Polished Chrome

\$245

Brushed Gold

\$355

Custom Finish

\$490
61934 2 & 3 way diverter

Rough

\$195

R3195 plate and handle trim set

- 4^{1/4}" x 11" x 1/8"
- requires #12001 TURBO thermostatic valve

Polished Chrome

\$260

Brushed Gold

\$455

Custom Finish

\$520
T12001 TURBO thermostatic valve with 1 shut-off valve - 3/4" - 1/2"

Rough

\$625

R3295 plate and handle trim set

- 4^{1/4}" x 13^{3/4}" x 1/8"
- requires #12002 TURBO thermostatic valve

Polished Chrome

\$375

Brushed Gold

\$655

Custom Finish

\$750
T12002 TURBO thermostatic valve with 2 shut-off valve - 3/4" - 1/2"

Rough

\$795

R3395 plate and handle trim set

- 4^{1/4}" x 16^{3/4}" x 1/8"
- requires #12003 TURBO thermostatic valve

Polished Chrome

\$495

Brushed Gold

\$865

Custom Finish

\$990
T12003 TURBO thermostatic valve with 3 shut-off valve - 3/4" - 1/2"

Rough

\$965



MARMO

TOSCA

OTTO

VITTORIO

REGENCY

ETNA

CUT



MB2

XROUND

GEO

TIME

BLOK

VOLARE

FOLIA



MIDTOWN

MUST

BLADE

LOVEME

ALPHA

METRO

CHICANE



B-JOU

MADISON

XSQUARE

STREEM

SOLO

DRAINS

MB2



R3495 plate and handle trim set

- 4^{1/4}"x19^{5/8}"x1/8"
- requires #12004 TURBO thermostatic valve

Polished Chrome

\$625

Brushed Gold

\$1075

Custom Finish

\$1250

T12004 TURBO thermostatic valve with 4 shut-off valve - 3/4" - 1/2"

Rough

\$1135

R8295 plate and handle trim set with 2-way diverter

- shared functions
- 4^{1/4}"x12"x1/8"
- requires #T12123 Turbo Uniplex thermostatic valve

Polished Chrome

\$350

Brushed Gold

\$615

Custom Finish

\$700

2-way

T12123 TURBO UNIPLEX thermostatic valve 3/4" - 1/2"

Rough

\$495

R9295 plate and handle trim set with 2-way diverter

- 1 function at a time
- 4^{1/4}"x12"x1/8"
- requires #T12123 Turbo Uniplex thermostatic valve

Polished Chrome

\$350

Brushed Gold

\$615

Custom Finish

\$700

2-way

T12123 TURBO UNIPLEX thermostatic valve 3/4" - 1/2"

Rough

\$495

R8395 plate and handle trim set with 3-way diverter

- shared functions
- 4^{1/4}"x12"x1/8"
- requires #T12123 Turbo Uniplex thermostatic valve

Polished Chrome

\$350

Brushed Gold

\$615

Custom Finish

\$700

3-way

T12123 TURBO UNIPLEX thermostatic valve 3/4" - 1/2"

Rough

\$495

R9395 plate and handle trim set with 3-way diverter

- 1 function at a time
- 4^{1/4}"x12"x1/8"
- requires #T12123 Turbo Uniplex thermostatic valve

Polished Chrome

\$350

Brushed Gold

\$615

Custom Finish

\$700

3-way

T12123 TURBO UNIPLEX thermostatic valve 3/4" - 1/2"

Rough

\$495

MB095 knurled thermostatic control for TURBO valves



- Polished Chrome **\$115**
- Brushed Gold **\$195**
- ✦ Custom Finish **\$230**

R4095 plate and handle trim set



- 8"x1/8"
- requires #40255 pressure balance valve

- Polished Chrome **\$135**
- Brushed Gold **\$235**
- ✦ Custom Finish **\$270**

40255 1/2" pressure balance valve for shower

- due to visible rough parts, select matching finish

- Polished Chrome **\$235**
- Brushed Gold **\$415**
- ✦ Custom Finish **\$470**

R4295 plate and handle trim set



- 8"x1/8"
- requires #42355 pressure balance valve

- Polished Chrome **\$165**
- Brushed Gold **\$290**
- ✦ Custom Finish **\$330**

42355 1/2" pressure balance valve for tub / shower

- due to visible rough parts, select matching finish

- Polished Chrome **\$425**
- Brushed Gold **\$745**
- ✦ Custom Finish **\$850**

XROUND

AVAILABLE FINISHES

polished chrome



XROUND collection is also available
in Aquabrass' custom finishes
(10 weeks lead time, see finish chart p.vii)





MARMO

TOSCA

OTTO

VITTORIO

REGENCY

ETNA

CUT

XROUND



X7514 single-hole lavatory faucet

- solid brass construction
- recessed aerator – aerated water flow
- press pop-up drain with overflow included
- 3/8" connection

height: 14^{1/2"}
 overall projection: 5^{1/2"}
 flow rate: 2.2 gpm



ABCA X7565

Polished Chrome

\$650

Custom Finish

\$1300

MB2

XROUND

GEO

TIME

BLOK

VOLARE

FOLIA



X7512 2-piece lavatory faucet with side joystick

- solid brass construction
- recessed aerator – aerated water flow
- single volume and temperature side joystick control
- press pop-up drain with overflow included
- 3/8" connection

height: 8"
 overall projection: 5"
 flow rate: 2.2 gpm



ABCA50495

Polished Chrome

\$650

Custom Finish

\$1300

MIDTOWN

MUST

BLADE

LOVEME

ALPHA

METRO

CHICANE



X75N83 floormount lavatory faucet

- solid brass construction
- recessed aerator – aerated water flow
- press pop-up drain with overflow included
- rough-in not included, order #92189
- 1/2" female connection with quick connect

height: 43^{13/16"}
 overall projection: 5^{3/4"}
 flow rate: 2.2 gpm



ABCA X7565

Polished Chrome

\$995

Custom Finish

\$1990

92189 rough-in for wallmount tub filler X75N83

- 1/2" NPT male connection

Rough-in

\$595

B-JOU

MADISON

XSQUARE

STREEM

SOLO



X7510 widespread lavatory faucet

- solid brass construction
- recessed aerator – aerated water flow
- press pop-up drain with overflow included
- 1/2" connection

height: 8"
 overall projection: 5"
 flow rate: 2.2 gpm

ABCA30911 / HOT
ABCA30921 / COLD

Polished Chrome

\$795

Custom Finish

\$1590



X75N85 floormount tub filler with handshower

- solid brass construction
- recessed aerator – aerated water flow
- handshower with 5' double-helix brass hose
- rough-in not included, order # **92189**
- 1/2" female connection with quick connect

height: 38^{1/2"}

overall projection: 5^{15/16"}

flow rate: (tub filler) 5 gpm
(handshower) 2.5 gpm



Polished Chrome **\$1695**

Custom Finish **\$3390**

92189 rough-in for wallmount tub filler X75N85

- 1/2" NPT male connection

Rough-in **\$595**



X75N95 floormount tub filler with handshower

- solid brass construction
- recessed aerator – aerated water flow
- handshower with 5' double-helix brass hose
- rough-in not included, order # **92189**
- 1/2" female connection with quick connect

height: 38^{1/2"}

overall projection: 10^{3/16"}

flow rate: (tub filler) 5 gpm
(handshower) 2.5 gpm



Polished Chrome **\$1750**

Custom Finish **\$3500**

92189 rough-in for wallmount tub filler X75N95

- 1/2" NPT male connection

Rough-in **\$595**



X7513 3-piece deckmount tub filler with handshower

- solid brass construction
- recessed aerator – aerated water flow
- pressure balance volume control mixing valve
- handshower with 5' double-helix hidden hose
- 1/2" connection

height: 11"

overall projection: 6^{3/4"}

flow rate: (tub filler) 5.8 gpm (handshower) 2.5 gpm

Polished Chrome **\$895**

Custom Finish **\$1790**





MARMO

TOSCA

OTTO

VITTORIO

REGENCY

ETNA

CUT

XROUND

X7526 4 hole bidet set



- solid brass construction
- incorporated vacuum breaker and vertical spray
- mechanical drain included
- 1/2" connection

height: 4^{11/16}"
flow rate: full flow

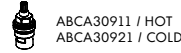
Polished Chrome **\$1350**Custom Finish **\$2700**

MB2

XROUND

GEO

TIME

BLOK

VOLARE

FOLIA



MIDTOWN

MUST

BLADE

LOVEME

ALPHA

METRO

CHICANE



B-JOU

MADISON

XSQUARE

STREEM

SOLO

Shower Valves & Trim Set Solutions

(for complete program, see pages 241 - 292)



R3095 plate and handle trim set

- 4^{1/4}"x7^{7/8}"x1/8"
- requires #12000 TURBO thermostatic valve with a choice of a shut-off valve (#1206) or a 2-3 way diverter (#61934)

Polished Chrome **\$150**Custom Finish **\$300**

T12000 TURBO thermostatic valve 3/4" - 1/2"

Rough **\$455**

R0695 plate and handle trim set

- 3^{1/4}"x1/8"
- requires #1206 shut-off valve

Polished Chrome **\$130**Custom Finish **\$260**

1206 TURBO 1/2" shut-off valve

Rough **\$165**

93921 plate and handle trim set with 2-way diverter

Polished Chrome **\$245**

- **WITH STOP – shared functions**
- replaces the functionality of 2 shut-off valves
- 2^{3/4}"x1/8"
- requires #61934 diverter

Custom Finish **\$490**

2-way

61934 2 & 3 way diverter

Rough **\$195**



2-way

93821 plate and handle trim set with 2-way diverter
• WITH STOP – 1 function at a time

- replaces the functionality of 2 shut-off valves
- 2^{3/4}" x 1/8"
- requires #61934 diverter

Polished Chrome

\$245

Custom Finish

\$490
61934 2 & 3 way diverter

Rough

\$195

3-way

93931 plate and handle trim set with 3-way diverter
• WITH STOP – shared functions

- replaces the functionality of 3 shut-off valves
- 2^{3/4}" x 1/8"
- requires #61934 diverter

Polished Chrome

\$245

Custom Finish

\$490
61934 2 & 3 way diverter

Rough

\$195

3-way

93831 plate and handle trim set with 3-way diverter
• WITH STOP – 1 function at a time

- replaces the functionality of 3 shut-off valves
- 2^{3/4}" x 1/8"
- requires #61934 diverter

Polished Chrome

\$245

Custom Finish

\$490
61934 2 & 3 way diverter

Rough

\$195

R3195 plate and handle trim set

- 4^{1/4}" x 1 1/8"
- requires #12001 TURBO thermostatic valve

Polished Chrome

\$260

Custom Finish

\$520
T12001 TURBO thermostatic valve with 1 shut-off valve - 3/4" - 1/2"

Rough

\$625

R3295 plate and handle trim set

- 4^{1/4}" x 1 3/4" x 1/8"
- requires #12002 TURBO thermostatic valve

Polished Chrome

\$375

Custom Finish

\$750
T12002 TURBO thermostatic valve with 2 shut-off valve - 3/4" - 1/2"

Rough

\$795



MARMO

TOSCA

OTTO

VITTORIO

REGENCY

ETNA

CUT

XROUND

**R3395 plate and handle trim set**

- 4^{1/4"}x16^{3/4"}x1/8"
- requires # 12003 TURBO thermostatic valve

Polished Chrome

\$495

Custom Finish

\$990**T12003 TURBO thermostatic valve with 3 shut-off valve - 3/4" - 1/2"**

Rough

\$965**R3495 plate and handle trim set**

- 4^{1/4"}x19^{5/8"}x1/8"
- requires # 12004 TURBO thermostatic valve

Polished Chrome

\$625

Custom Finish

\$1250**T12004 TURBO thermostatic valve with 4 shut-off valve - 3/4" - 1/2"**

Rough

\$1135**R8295 plate and handle trim set with 2-way diverter**

- shared functions
- 4^{1/4"}x12"x1/8"
- requires #T12123 Turbo Uniplex thermostatic valve

Polished Chrome

\$350

Custom Finish

\$700**T12123 TURBO UNIPLEX thermostatic valve 3/4" - 1/2"**

Rough

\$495

2-way

**R9295 plate and handle trim set with 2-way diverter**

- 1 function at a time
- 4^{1/4"}x12"x1/8"
- requires #T12123 Turbo Uniplex thermostatic valve

Polished Chrome

\$350

Custom Finish

\$700**T12123 TURBO UNIPLEX thermostatic valve 3/4" - 1/2"**

Rough

\$495

2-way

**R8395 plate and handle trim set with 3-way diverter**

- shared functions
- 4^{1/4"}x12"x1/8"
- requires #T12123 Turbo Uniplex thermostatic valve

Polished Chrome

\$350

Custom Finish

\$700**T12123 TURBO UNIPLEX thermostatic valve 3/4" - 1/2"**

Rough

\$495

3-way



MB2

XROUND

GEO

TIME

BLOK

VOLARE

FOLIA



MIDTOWN

MUST

BLADE

LOVEME

ALPHA

METRO

CHICANE



B-JOU

MADISON

XSQUARE

STREEM

SOLO

DRAINS



3-way

R9395 plate and handle trim set with 3-way diverter
 • 1 function at a time
 • 4^{1/4}"x12"x1/8"
 • requires #T12123 Turbo Uniplex thermostatic valve

Polished Chrome **\$350**
 Custom Finish **\$700**

T12123 TURBO UNIPLEX thermostatic valve 3/4" - 1/2"

Rough **\$495**



R4095 plate and handle trim set
 • 8"x1/8"
 • requires #40255 pressure balance valve

Polished Chrome **\$135**
 Custom Finish **\$270**

40255 1/2" pressure balance valve for shower
 • due to visible rough parts, select matching finish

Polished Chrome **\$235**
 Custom Finish **\$470**



R4295 plate and handle trim set
 • 8"x1/8"
 • requires #42355 pressure balance valve

Polished Chrome **\$165**
 Custom Finish **\$330**

42355 1/2" pressure balance valve for tub / shower
 • due to visible rough parts, select matching finish

Polished Chrome **\$425**
 Custom Finish **\$850**

GEO

AVAILABLE FINISHES

polished chrome



brushed nickel



electro black

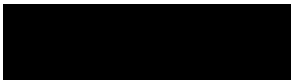

brushed gold



GEO collection is also available
in Aquabross' custom finishes
(10 weeks lead time, see finish chart p.vii)

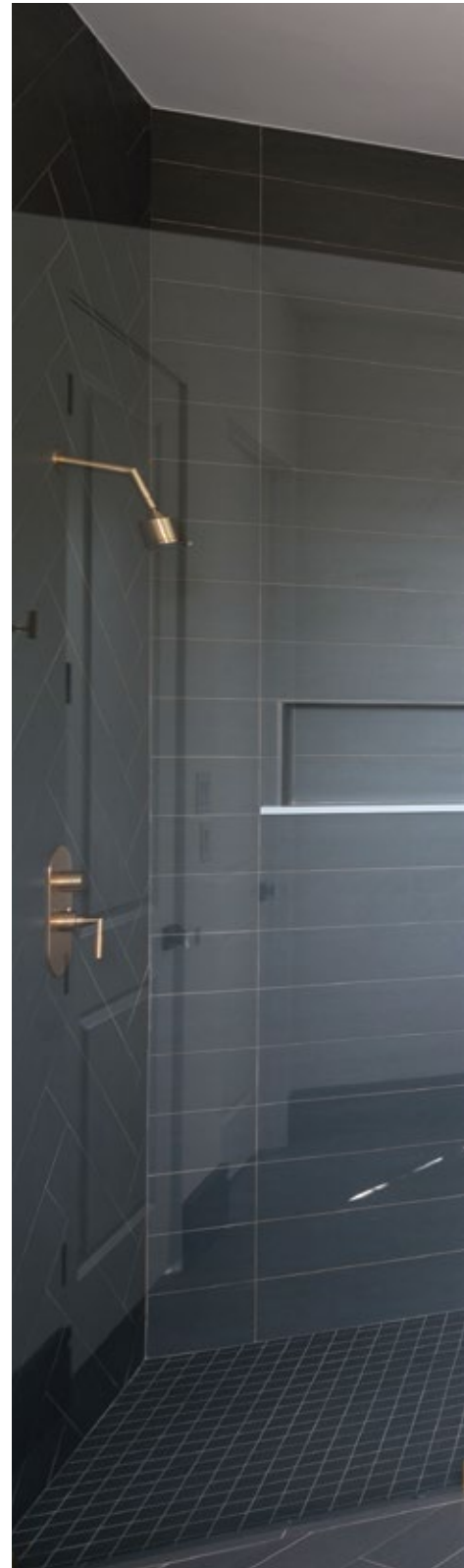





MARMO

TOSCA

OTTO

VITTORIO

REGENCY

ETNA

CUT



MB2

XROUND

GEO

TIME

BLOK

VOLARE

FOLIA



MIDTOWN

MUST

BLADE

LOVEME

ALPHA

METRO

CHICANE



B-JOU

MADISON

XSQUARE

STREEM

SOLO

DRAINS

GEO



27414 single-hole lavatory faucet

- solid brass construction
- aerated water flow
- press pop-up drain with overflow included
- 3/8" connection

height: 5^{7/8}"
overall projection: 6"
flow rate: 1.5 gpm



ABCA04075

Polished Chrome	\$325
Brushed Nickel	\$425
Electro Black	\$565
Brushed Gold	\$565
Custom Finish	\$650



27420 tall single-hole lavatory faucet

- solid brass construction
- aerated water flow
- press pop-up drain with overflow included
- 3/8" connection

height: 13"
overall projection: 8^{3/8}"
flow rate: 1.5 gpm



ABCA04075

Polished Chrome	\$475
Brushed Nickel	\$615
Electro Black	\$835
Brushed Gold	\$835
Custom Finish	\$950



27416 widespread lavatory faucet

- solid brass construction
- aerated water flow
- press pop-up drain with overflow included
- swiveling aerator (7.5 degree rotation) to redirect flow
- 3/8" connection

height: 10^{1/2}"
overall projection: 6^{7/8}"
flow rate: 1.5 gpm

ABCA30911 / HOT
ABCA30921 / COLD

Polished Chrome	\$525
Brushed Nickel	\$685
Electro Black	\$895
Brushed Gold	\$895
Custom Finish	\$1050



27N29 wallmount 8" c.c. lavatory faucet

- solid brass construction
- aerated water flow
- drain not included, see page 212 for options
- rough-in not included, order #83229

height: 2^{9/16}"
overall projection: 8"
flow rate: 2.2 gpm

ABCA82411 / HOT
ABCA82421 / COLD

Polished Chrome	\$425
Brushed Nickel	\$555
Electro Black	\$745
Brushed Gold	\$745
Custom Finish	\$850

83229 rough-in for wallmount faucet #27N29

- 1/2" NPT connection

Rough-in **\$195**





27412 2-piece lavatory faucet with side joystick

- solid brass construction
- aerated water flow
- single volume and temperature side joystick control
- press pop-up drain with overflow included
- 3/8" connection

height: 10^{1/2}"
overall projection: 6^{5/16}"
flow rate: 1.5 gpm



- Polished Chrome **\$595**
- Brushed Nickel **\$775**
- Electro Black **\$995**
- Brushed Gold **\$995**
- Custom Finish **\$1190**



27N84 floormount tub filler with handshower

- solid brass construction
- aerated water flow
- handshower with 5' reinforced PVC hose
- pull-button diverter in front of the spout
- 1/2" connection

height: 40^{3/4}"
overall projection: 11"
flow rate: (tub filler) 4.5 gpm
(handshower) 2.5 gpm



- Polished Chrome **\$1295**
- Brushed Nickel **\$1685**
- Electro Black **\$2250**
- Brushed Gold **\$2250**
- Custom Finish **\$2590**

Easy-Fit™ adaptors give extra play room and snap when faucet is pushed down

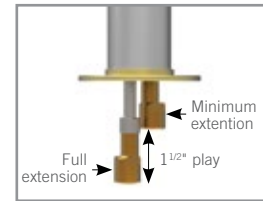

Easy-Fit™ adaptors included for an easy, fast and simple installation (see installation guide for details)



27424 single-hole bidet faucet with swivel spray

- solid brass construction
- mechanical drain with included
- 20° swivel aerator
- 3/8" connection

height: 5^{7/8}"
overall projection: 5^{5/8}"
flow rate: 2.2 gpm



- Polished Chrome **\$395**
- Brushed Nickel **\$515**
- Electro Black **\$690**
- Brushed Gold **\$690**
- Custom Finish **\$790**



27426 4 hole bidet set

- solid brass construction
- incorporated vacuum breaker & vertical spray
- mechanical drain included
- 1/2" connection

height: 4^{11/16}"
flow rate: full flow

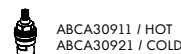

- Polished Chrome **\$1350**
- Brushed Nickel **\$1750**
- Electro Black **\$2350**
- Brushed Gold **\$2350**
- Custom Finish **\$2700**



MARMO

TOSCA

OTTO

VITTORIO

REGENCY

ETNA

CUT

GEO

Shower Valves & Trim Set Solutions

(for complete program, see pages 241 - 292)



R3075 plate and handle trim set

- 4^{1/4}" x 7^{7/8}" x 1/8"
- requires # 12000 TURBO thermostatic valve with a choice of a shut-off valve (# 1206) or a 2-3 way diverter (# 61934)

Polished Chrome	\$245
Brushed Nickel	\$320
Electro Black	\$415
Brushed Gold	\$415
✦ Custom Finish	\$490

T12000 TURBO thermostatic valve 3/4" - 1/2"

Rough	\$455
-------	--------------



R0695 plate and handle trim set

- 3^{1/4}" x 1/8"
- requires # 1206 shut-off valve

Polished Chrome	\$130
Brushed Nickel	\$165
Electro Black	\$225
Brushed Gold	\$225
✦ Custom Finish	\$260

1206 TURBO 1/2" shut-off valve

Rough	\$165
-------	--------------

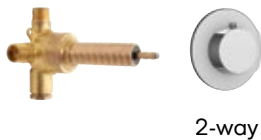

2-way

93921 plate and handle trim set with 2-way diverter

- **WITH STOP – shared functions**
- replaces the functionality of 2 shut-off valves
- 2^{3/4}" x 1/8"
- requires # 61934 diverter

Polished Chrome	\$245
Brushed Nickel	\$295
Electro Black	\$355
Brushed Gold	\$355
✦ Custom Finish	\$490

61934 2 & 3 way diverter

Rough	\$195
-------	--------------

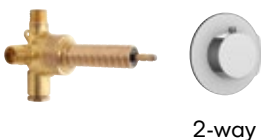

2-way

93821 plate and handle trim set with 2-way diverter

- **WITH STOP – 1 function at a time**
- replaces the functionality of 2 shut-off valves
- 2^{3/4}" x 1/8"
- requires # 61934 diverter

Polished Chrome	\$245
Brushed Nickel	\$295
Electro Black	\$355
Brushed Gold	\$355
✦ Custom Finish	\$490

61934 2 & 3 way diverter

Rough	\$195
-------	--------------



MB2

XROUND

GEO

TIME

BLOK

VOLARE

FOLIA



MIDTOWN

MUST

BLADE

LOVEME

ALPHA

METRO

CHICANE



B-JOU

MADISON

XSQUARE

STREEM

SOLO

DRAINS



3-way

93931 plate and handle trim set with 3-way diverter

• WITH STOP – shared functions

- replaces the functionality of 3 shut-off valves
- 2^{3/4"} x 1/8"
- requires #61934 diverter

Polished Chrome **\$245**

Brushed Nickel **\$295**

Electro Black **\$355**

Brushed Gold **\$355**

✦ Custom Finish **\$490**

61934 2 & 3 way diverter

Rough **\$195**



3-way

93831 plate and handle trim set with 3-way diverter

• WITH STOP – 1 function at a time

- replaces the functionality of 3 shut-off valves
- 2^{3/4"} x 1/8"
- requires #61934 diverter

Polished Chrome **\$245**

Brushed Nickel **\$295**

Electro Black **\$355**

Brushed Gold **\$355**

✦ Custom Finish **\$490**

61934 2 & 3 way diverter

Rough **\$195**



R3175 plate and handle trim set

- 4^{1/4"} x 11" x 1/8"
- requires #12001 TURBO thermostatic valve

Polished Chrome **\$355**

Brushed Nickel **\$465**

Electro Black **\$620**

Brushed Gold **\$620**

✦ Custom Finish **\$710**

T12001 TURBO thermostatic valve with 1 shut-off valve - 3/4" - 1/2"

Rough **\$625**



R3275 plate and handle trim set

- 4^{1/4"} x 13^{3/4"} x 1/8"
- requires #12002 TURBO thermostatic valve

Polished Chrome **\$470**

Brushed Nickel **\$615**

Electro Black **\$820**

Brushed Gold **\$820**

✦ Custom Finish **\$940**

T12002 TURBO thermostatic valve with 2 shut-off valve - 3/4" - 1/2"

Rough **\$795**



R3375 plate and handle trim set

- 4^{1/4"} x 16^{3/4"} x 1/8"
- requires #12003 TURBO thermostatic valve

Polished Chrome **\$590**

Brushed Nickel **\$770**

Electro Black **\$1030**

Brushed Gold **\$1030**

✦ Custom Finish **\$1180**

T12003 TURBO thermostatic valve with 3 shut-off valve - 3/4" - 1/2"

Rough **\$965**



MARMO

TOSCA

OTTO

VITTORIO

REGENCY

ETNA

CUT



MB2

XROUND

GEO

TIME

BLOK

VOLARE

FOLIA



MIDTOWN

MUST

BLADE

LOVEME

ALPHA

METRO

CHICANE



B-JOU

MADISON

XSQUARE

STREEM

SOLO

DRAINS

GEO



R3475 plate and handle trim set

- 4^{1/4}"x19^{5/8}"x1/8"
- requires #12004 TURBO thermostatic valve

Polished Chrome **\$720**
 Brushed Nickel **\$940**
 Electro Black **\$1240**
 Brushed Gold **\$1240**

✦ Custom Finish **\$1440**

T12004 TURBO thermostatic valve with 4 shut-off valve - 3/4" - 1/2"

Rough **\$1135**



2-way

R8275 plate and handle trim set with 2-way diverter

- shared functions
- 4^{1/4}"x12"x1/8"
- requires #T12123 Turbo Uniplex thermostatic valve

Polished Chrome **\$445**
 Brushed Nickel **\$580**
 Electro Black **\$780**
 Brushed Gold **\$780**

✦ Custom Finish **\$890**

T12123 TURBO UNIPLEX thermostatic valve 3/4" - 1/2"

Rough **\$495**



2-way

R9275 plate and handle trim set with 2-way diverter

- 1 function at a time
- 4^{1/4}"x12"x1/8"
- requires #T12123 Turbo Uniplex thermostatic valve

Polished Chrome **\$445**
 Brushed Nickel **\$580**
 Electro Black **\$780**
 Brushed Gold **\$780**

✦ Custom Finish **\$890**

T12123 TURBO UNIPLEX thermostatic valve 3/4" - 1/2"

Rough **\$495**



3-way

R8375 plate and handle trim set with 3-way diverter

- shared functions
- 4^{1/4}"x12"x1/8"
- requires #T12123 Turbo Uniplex thermostatic valve

Polished Chrome **\$445**
 Brushed Nickel **\$580**
 Electro Black **\$780**
 Brushed Gold **\$780**

✦ Custom Finish **\$890**

T12123 TURBO UNIPLEX thermostatic valve 3/4" - 1/2"

Rough **\$495**



3-way

R9375 plate and handle trim set with 3-way diverter

- 1 function at a time
- 4^{1/4}"x12"x1/8"
- requires #T12123 Turbo Uniplex thermostatic valve

Polished Chrome **\$445**
 Brushed Nickel **\$580**
 Electro Black **\$780**
 Brushed Gold **\$780**

✦ Custom Finish **\$890**

T12123 TURBO UNIPLEX thermostatic valve 3/4" - 1/2"

Rough **\$495**



R4075 plate and handle trim set
 • 8"x1/8"
 • requires #40255 pressure balance valve

Polished Chrome **\$200**
 Brushed Nickel **\$260**
 Electro Black **\$350**
 Brushed Gold **\$350**
 ✦ Custom Finish **\$400**

40255 1/2" pressure balance valve for shower
 • due to visible rough parts, select matching finish

Polished Chrome **\$235**
 Brushed Nickel **\$265**
 Electro Black **\$415**
 Brushed Gold **\$415**
 ✦ Custom Finish **\$470**

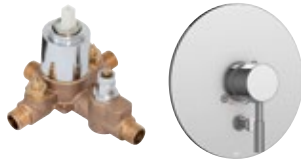

R4275 plate and handle trim set
 • 8"x1/8"
 • requires #42355 pressure balance valve

Polished Chrome **\$230**
 Brushed Nickel **\$300**
 Electro Black **\$405**
 Brushed Gold **\$405**
 ✦ Custom Finish **\$460**

42355 1/2" pressure balance valve for tub / shower
 • due to visible rough parts, select matching finish

Polished Chrome **\$425**
 Brushed Nickel **\$485**
 Electro Black **\$745**
 Brushed Gold **\$745**
 ✦ Custom Finish **\$850**

TIME

AVAILABLE FINISHES

polished chrome



brushed nickel



CHOICE OF OPTIONAL HANDLES



red



black

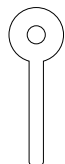

white

Body of the faucet in polished chrome:

PC: Polished chrome lever

PC**RD**: Red lever

PC**BK**: Black lever

PC**WH**: White lever

Body of the faucet in brushed nickel:

BN: Brushed nickel lever

BN**RD**: Red lever

BN**BK**: Black lever

BN**WH**: White lever





MARMO

TOSCA

OTTO

VITTORIO

REGENCY

ETNA

CUT

TIME



51014 single-hole lavatory faucet

- solid brass construction
- aerated water flow
- press pop-up drain with overflow included
- 3/8" connection

height: 6^{3/8"}
 overall projection: 7^{3/16"}
 flow rate: 2.2 gpm



ABCA51099

Polished Chrome **\$650**
PCRD **\$650**
PCBK **\$650**
PCWH **\$650**

Brushed Nickel **\$850**
BNRD **\$850**
BNBK **\$850**
BNWH **\$850**



MB2

XROUND

GEO

TIME

BLOK

VOLARE

FOLIA



51020 tall single-hole lavatory faucet

- solid brass construction
- aerated water flow
- press pop-up drain with overflow included
- 3/8" connection

height: 9"
 overall projection: 6^{3/4"}
 flow rate: 2.2 gpm



ABCA51099

Polished Chrome **\$775**
PCRD **\$775**
PCBK **\$775**
PCWH **\$775**

Brushed Nickel **\$995**
BNRD **\$995**
BNBK **\$995**
BNWH **\$995**



MIDTOWN

MUST

BLADE

LOVEME

ALPHA

METRO

CHICANE



51N29 wallmount lavatory faucet

- solid brass construction
- aerated water flow
- drain not included, see page 212 for options
- rough-in not included, order # **CB329**

height: (w/ plate) 2^{3/4"}
 overall projection: 10^{3/8"}
 flow rate: 2.2 gpm



ABCA51897



ABSPEX3M29

Polished Chrome **\$650**
PCRD **\$650**
PCBK **\$650**
PCWH **\$650**

Brushed Nickel **\$850**
BNRD **\$850**
BNBK **\$850**
BNWH **\$850**

CB329 rough-in for wallmount faucet # 51N29

- 1/2" NPT male connection

Rough-in **\$295**



B-JOU

MADISON

XSQUARE

STREEM

SOLO

DRAINS



51N04 4-piece wallmount tub filler with handshower

- solid brass construction
- aerated water flow
- 2 independent single volume and temperature mixing valves
- handshower with 5' reinforced pvc hose
- rough-in not included, order # **CB304**

height: 4^{11/16"}
 overall projection: 7^{15/16"}
 flow rate: (tub filler) 5 gpm
 (handshower) 2.5 gpm

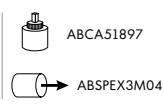

Polished Chrome **\$1450**
 PCR**D** **\$1450**
 PCB**K** **\$1450**
 PCW**H** **\$1450**

Brushed Nickel **\$1895**
 BN**RD** **\$1895**
 BNB**K** **\$1895**
 BNW**H** **\$1895**



CB304 rough-in for wallmount tub filler 51N04

- 1/2" NPT male connection

Rough-in **\$795**



51N85 floormount tub filler with handshower

- solid brass construction
- aerated water flow
- handshower with 5' reinforced pvc hose
- 2 independent mixing valves
- rough-in not included, order # **92189**
- 1/2" connection

height: 34^{5/8"}
 overall projection: 12^{3/16"}
 flow rate: (tub filler) 5.5 gpm
 (handshower) 2.5 gpm



Polished Chrome **\$2350**
 PCR**D** **\$2350**
 PCB**K** **\$2350**
 PCW**H** **\$2350**

Brushed Nickel **\$2995**
 BN**RD** **\$2995**
 BNB**K** **\$2995**
 BNW**H** **\$2995**

92189 rough-in for wallmount tub filler 51N85

- 1/2" NPT male connection



Rough-in **\$595**



MARMO

TOSCA

OTTO

VITTORIO

REGENCY

ETNA

CUT

TIME

Shower Valves & Trim Set Solutions

(for complete program, see pages 241 - 292)

**SR3051 plate and handle trim set**

- 4^{1/4}" x 7^{7/8}" x 1/8"
- requires #12000 TURBO thermostatic valve with a choice of a shut-off valve (#1206) or a 2-3 way diverter (#61934)

Polished Chrome **\$290**
 Brushed Nickel **\$380**

T12000 TURBO thermostatic valve 3/4" - 1/2"

Rough **\$455**

**SR0695 plate and handle trim set**

- 3^{1/4}" x 4^{1/4}" x 1/8"
- requires #1206 shut-off valve

Polished Chrome **\$160**
 Brushed Nickel **\$205**

1206 1/2" shut-off valve

Rough **\$165**



2-way

93922 plate and handle trim set with 2-way diverter

- **WITH STOP – shared functions**
- replaces the functionality of 2 shut-off valves
- 2^{3/4}" x 2^{3/4}" x 1/8"
- requires #61934 diverter

Polished Chrome **\$275**
 Brushed Nickel **\$325**

61934 2 & 3 way diverter

Rough **\$195**



2-way

93822 plate and handle trim set with 2-way diverter

- **WITH STOP – 1 function at a time**
- replaces the functionality of 2 shut-off valves
- 2^{3/4}" x 2^{3/4}" x 1/8"
- requires #61934 diverter

Polished Chrome **\$275**
 Brushed Nickel **\$325**

61934 2 & 3 way diverter

Rough **\$195**



MB2

XROUND

GEO

TIME

BLOK

VOLARE

FOLIA



MIDTOWN

MUST

BLADE

LOVEME

ALPHA

METRO

CHICANE



B-JOU

MADISON

XSQUARE

STREEM

SOLO

DRAINS



3-way

93932 plate and handle trim set with 3-way diverter

• WITH STOP – shared functions

- replaces the functionality of 3 shut-off valves
- 2^{3/4}" x 2^{3/4}" x 1/8"
- requires # 61934 diverter

Polished Chrome **\$275**
Brushed Nickel **\$325**

61934 2 & 3 way diverter

Rough **\$195**



3-way

93832 plate and handle trim set with 3-way diverter

• WITH STOP – 1 function at a time

- replaces the functionality of 3 shut-off valves
- 2^{3/4}" x 2^{3/4}" x 1/8"
- requires # 61934 diverter

Polished Chrome **\$275**
Brushed Nickel **\$325**

61934 2 & 3 way diverter

Rough **\$195**



SR3151 plate and handle trim set

- 4^{1/4}" x 11" x 1/8"
- requires # 12001 TURBO thermostatic valve

Polished Chrome **\$435**
Brushed Nickel **\$570**

T12001 TURBO thermostatic valve with 1 shut-off valve - 3/4" - 1/2"

Rough **\$625**



SR3251 plate and handle trim set

- 4^{1/4}" x 13^{3/4}" x 1/8"
- requires # 12002 TURBO thermostatic valve

Polished Chrome **\$585**
Brushed Nickel **\$765**

T12002 TURBO thermostatic valve with 2 shut-off valve - 3/4" - 1/2"

Rough **\$795**



SR3351 plate and handle trim set

- 4^{1/4}" x 16^{3/4}" x 1/8"
- requires # 12003 TURBO thermostatic valve

Polished Chrome **\$740**
Brushed Nickel **\$965**

T12003 TURBO thermostatic valve with 3 shut-off valve - 3/4" - 1/2"

Rough **\$965**



MARMO

TOSCA

OTTO

VITTORIO

REGENCY

ETNA

CUT



MB2

XROUND

GEO

TIME

BLOK

VOLARE

FOLIA



MIDTOWN

MUST

BLADE

LOVEME

ALPHA

METRO

CHICANE



B-JOU

MADISON

XSQUARE

STREEM

SOLO

TIME

**SR3451 plate and handle trim set**

- 4^{1/4"}x12^{5/8"}x1/8"
- requires #12004 TURBO thermostatic valve

Polished Chrome **\$890**
Brushed Nickel **\$1175**

T12004 TURBO thermostatic valve with 4 shut-off valve - 3/4" - 1/2"

Rough **\$1135**



2-way

SR8251 plate and handle trim set with 2-way diverter

- shared functions
- 4^{1/4"}x12"x1/8"
- requires #T12123 Turbo Uniplex thermostatic valve

Polished Chrome **\$550**
Brushed Nickel **\$715**

T12123 TURBO UNIPLEX thermostatic valve 3/4" - 1/2"

Rough **\$495**



2-way

SR9251 plate and handle trim set with 2-way diverter

- 1 function at a time
- 4^{1/4"}x12"x1/8"
- requires #T12123 Turbo Uniplex thermostatic valve

Polished Chrome **\$550**
Brushed Nickel **\$715**

T12123 TURBO UNIPLEX thermostatic valve 3/4" - 1/2"

Rough **\$495**



3-way

SR8351 plate and handle trim set with 3-way diverter

- shared functions
- 4^{1/4"}x12"x1/8"
- requires #T12123 Turbo Uniplex thermostatic valve

Polished Chrome **\$550**
Brushed Nickel **\$715**

T12123 TURBO UNIPLEX thermostatic valve 3/4" - 1/2"

Rough **\$495**



3-way

SR9351 plate and handle trim set with 3-way diverter

- 1 function at a time
- 4^{1/4"}x12"x1/8"
- requires #T12123 Turbo Uniplex thermostatic valve

Polished Chrome **\$550**
Brushed Nickel **\$715**

T12123 TURBO UNIPLEX thermostatic valve 3/4" - 1/2"

Rough **\$495**



SR4095 plate and handle trim set

- 6^{1/2}"x8^{1/4}"x1/8"
- requires #40255 pressure balance valve

Polished Chrome **\$165**
Brushed Nickel **\$215**

40255 1/2" pressure balance valve for shower

- due to visible rough parts, select matching finish

Polished Chrome **\$235**
Brushed Nickel **\$265**



SR4295 plate and handle trim set

- 6^{1/2}"x8^{1/4}"x1/8"
- requires #42355 pressure balance valve

Polished Chrome **\$195**
Brushed Nickel **\$250**

42355 1/2" pressure balance valve for tub / shower

- due to visible rough parts, select matching finish

Polished Chrome **\$425**
Brushed Nickel **\$485**



MARMO

TOSCA

OTTO

VITTORIO

REGENCY

ETNA

CUT



MB2

XROUND

GEO

TIME

BLOK

VOLARE

FOLIA



MIDTOWN

MUST

BLADE

LOVEME

ALPHA

METRO

CHICANE



B-JOU

MADISON

X SQUARE

STREEM

SOLO

DRAINS

BLOK

AVAILABLE FINISH

polished chrome







MARMO

TOSCA

OTTO

VITTORIO

REGENCY

ETNA

CUT

BLOK



51914 wallmount single-hole lavatory faucet with shelf

Polished Chrome
(white shelf)**\$1850**

- solid brass construction (faucet) and Cristalplant™ (shelf)
- aerated water flow
- single volume and temperature control
- 3/8" connection

shelf: 23^{5/8"} x 5^{1/2"} x 2^{3/8"}overall projection: 7^{7/8"}

flow rate: 2.2 gpm



ABCA51998



MB2

XROUND

GEO

TIME

BLOK

VOLARE

FOLIA



51990 wallmount lavatory basin

White

\$3595

- Cristalplant™ construction
- press pop-up drain and p-trap included
- no overflow

height: 23^{3/4"}sink diameter: 14^{1/4"}

MIDTOWN

MUST

BLADE

LOVEME

ALPHA

METRO

CHICANE



B-JOU

MADISON

XSQUARE

STREEM

SOLO



51904 wallmount tub filler with handshower and shelf

Polished Chrome
(white shelf)**\$2295**









- solid brass construction (faucet) and Cristalplant™ (shelf)
- aerated water flow
- single volume and temperature control
- handshower inserted into shelf with 5' reinforced pvc hose
- 1/2" NPT male connection

shelf: 23^{5/8"} x 5^{1/2"} x 2^{3/8"}overall projection: 8^{1/4"}flow rate: (tub filler) 5.5 gpm
(handshower) 2.5 gpm

ABCA51998

Shower Valves & Trim Set Solutions

(for complete program, see pages 241 - 292)

		<p>R3095 plate and handle trim set</p> <ul style="list-style-type: none"> • 4^{1/4}"x7^{7/8}"x1/8" • requires # 12000 TURBO thermostatic valve with a choice of a shut-off valve (# 1206) or a 2-3 way diverter (# 61934) 	Polished Chrome	\$150
		T12000 TURBO thermostatic valve 3/4" - 1/2"	Rough	\$455
		<p>R0695 plate and handle trim set</p> <ul style="list-style-type: none"> • 3^{1/4}"x1/8" • requires # 1206 shut-off valve 	Polished Chrome	\$130
		1206 TURBO 1/2" shut-off valve	Rough	\$165
		<p>93921 plate and handle trim set with 2-way diverter</p> <ul style="list-style-type: none"> • WITH STOP – shared functions • replaces the functionality of 2 shut-off valves • 2^{3/4}"x1/8" • requires # 61934 diverter 	Polished Chrome	\$245
		61934 2 & 3 way diverter	Rough	\$195
		<p>93821 plate and handle trim set with 2-way diverter</p> <ul style="list-style-type: none"> • WITH STOP – 1 function at a time • replaces the functionality of 2 shut-off valves • 2^{3/4}"x1/8" • requires # 61934 diverter 	Polished Chrome	\$245
		61934 2 & 3 way diverter	Rough	\$195



MARMO

TOSCA

OTTO

VITTORIO

REGENCY

ETNA

CUT

BLOK



3-way

93931 plate and handle trim set with 3-way diverter

Polished Chrome

\$245**• WITH STOP – shared functions**

- replaces the functionality of 3 shut-off valves
- 2^{3/4}" x 1/8"
- requires #61934 diverter

61934 2 & 3 way diverter

Rough

\$195

3-way

93831 plate and handle trim set with 3-way diverter

Polished Chrome

\$245**• WITH STOP – 1 function at a time**

- replaces the functionality of 3 shut-off valves
- 2^{3/4}" x 1/8"
- requires #61934 diverter

61934 2 & 3 way diverter

Rough

\$195**R3195 plate and handle trim set**

Polished Chrome

\$260

- 4^{1/4}" x 11" x 1/8"
- requires #12001 TURBO thermostatic valve

T12001 TURBO thermostatic valve with 1 shut-off valve - 3/4" - 1/2"

Rough

\$625**R3295 plate and handle trim set**

Polished Chrome

\$375

- 4^{1/4}" x 13^{3/4}" x 1/8"
- requires #12002 TURBO thermostatic valve

T12002 TURBO thermostatic valve with 2 shut-off valve - 3/4" - 1/2"

Rough

\$795**R3395 plate and handle trim set**

Polished Chrome

\$495

- 4^{1/4}" x 16^{3/4}" x 1/8"
- requires #12003 TURBO thermostatic valve

T12003 TURBO thermostatic valve with 3 shut-off valve - 3/4" - 1/2"

Rough

\$965

B-JOU

MADISON

XSQUARE

STREEM

SOLO

DRAINS

R3495 plate and handle trim set

- 4^{1/4}"x19^{5/8}"x1/8"
- requires #12004 TURBO thermostatic valve

 Polished Chrome **\$625**
T12004 TURBO thermostatic valve with 4 shut-off valve - 3/4" - 1/2"

 Rough **\$1135**

R8295 plate and handle trim set with 2-way diverter

- shared functions
- 4^{1/4}"x12"x1/8"
- requires #T12123 Turbo Uniplex thermostatic valve

 Polished Chrome **\$350**
T12123 TURBO UNIPLEX thermostatic valve 3/4" - 1/2"

 Rough **\$495**

2-way

R9295 plate and handle trim set with 2-way diverter

- 1 function at a time
- 4^{1/4}"x12"x1/8"
- requires #T12123 Turbo Uniplex thermostatic valve

 Polished Chrome **\$350**
T12123 TURBO UNIPLEX thermostatic valve 3/4" - 1/2"

 Rough **\$495**

2-way

R8395 plate and handle trim set with 3-way diverter

- shared functions
- 4^{1/4}"x12"x1/8"
- requires #T12123 Turbo Uniplex thermostatic valve

 Polished Chrome **\$350**
T12123 TURBO UNIPLEX thermostatic valve 3/4" - 1/2"

 Rough **\$495**

3-way

R9395 plate and handle trim set with 3-way diverter

- 1 function at a time
- 4^{1/4}"x12"x1/8"
- requires #T12123 Turbo Uniplex thermostatic valve

 Polished Chrome **\$350**
T12123 TURBO UNIPLEX thermostatic valve 3/4" - 1/2"

 Rough **\$495**

3-way



MARMO

TOSCA

OTTO

VITTORIO

REGENCY

ETNA

CUT

BLOK



R4095 plate and handle trim set

Polished Chrome

\$135

- 8"x1/8"
- requires #40255 pressure balance valve

40255 1/2" pressure balance valve for shower

Polished Chrome

\$235

- due to visible rough parts, select matching finish



MB2

XROUND

GEO

TIME

BLOK

VOLARE

FOLIA

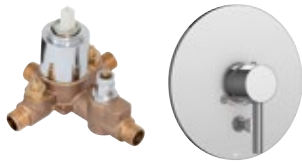

R4295 plate and handle trim set

Polished Chrome

\$165

- 8"x1/8"
- requires #42355 pressure balance valve

42355 1/2" pressure balance valve for tub / shower

Polished Chrome

\$425

- due to visible rough parts, select matching finish



MIDTOWN

MUST

BLADE

LOVEME

ALPHA

METRO

CHICANE



B-JOU

MADISON

X SQUARE

STREEM

SOLO

DRAINS



MARMO

TOSCA

OTTO

VITTORIO

REGENCY

ETNA

CUT



MB2

XROUND

GEO

TIME

BLOK

VOLARE

FOLIA



MIDTOWN

MUST

BLADE

LOVEME

ALPHA

METRO

CHICANE



B-JOU

MADISON

X SQUARE

STREEM

SOLO

DRAINS

VOLARE

AVAILABLE FINISHES

polished chrome



brushed nickel



 VOLARE collection is also available
in Aquabross' custom finishes
(10 weeks lead time, see finish chart p.vii)







MARMO

TOSCA

OTTO

VITTORIO

REGENCY

ETNA

CUT

VOLARE

**61044 small single-hole lavatory faucet**

- solid brass construction
- aerated water flow
- press pop-up drain with overflow included
- 3/8" connection

height: 5^{1/8"}
 overall projection: 5^{3/8"}
 flow rate: 2.2 gpm



- Polished Chrome **\$395**
 Brushed Nickel **\$515**
 Custom Finish **\$790**



MB2

XROUND

GEO

TIME

BLOK

VOLARE

FOLIA



MIDTOWN

MUST

BLADE

LOVEME

ALPHA

METRO

CHICANE

**61014 single-hole lavatory faucet**

- solid brass construction
- aerated water flow
- press pop-up drain with overflow included
- 3/8" connection

height: 5^{13/16"}
 overall projection: 5^{13/16"}
 flow rate: 2 gpm



- Polished Chrome **\$325**
 Brushed Nickel **\$425**
 Custom Finish **\$650**

**61020 tall single-hole lavatory faucet**

- solid brass construction
- aerated water flow
- press pop-up drain with overflow included
- 3/8" connection

height: 13^{1/16"}
 overall projection: 6"
 flow rate: 2 gpm



- Polished Chrome **\$475**
 Brushed Nickel **\$615**
 Custom Finish **\$950**

61028 wallmount lavatory faucet

- rough included
- solid brass construction
- aerated water flow
- drain not included, see page 212 for options
- 1/2" NPT female connection

height: 2^{3/8"}
 overall projection: 7^{3/8"}
 flow rate: 2 gpm



- Polished Chrome **\$595**
 Brushed Nickel **\$775**
 Custom Finish **\$1190**

**61029 wallmount lavatory faucet**

- rough included
- solid brass construction
- aerated water flow
- drain not included, see page 212 for options
- 1/2" NPT female connection

height: 2^{3/8"}
 overall projection: 8^{5/8"}
 flow rate: 2 gpm



- Polished Chrome **\$595**
 Brushed Nickel **\$775**
 Custom Finish **\$1190**



B-JOU

MADISON

XSQUARE

STREEM

SOLO

DRAINS



61013 3-piece deckmount tub filler with handshower

- solid brass construction
- aerated water flow
- pressure balance volume control mixing valve
- handshower with 5' double-helix hidden hose
- 1/2" connection

height: 7^{13/16}"
 overall projection: 9"
 flow rate: (tub filler) 5.5 gpm (handshower) 2.5 gpm

Polished Chrome **\$655**
 Brushed Nickel **\$850**
 Custom Finish **\$1310**



61N84 floormount tub filler with handshower

- solid brass construction
- aerated water flow
- handshower with 5' double-helix brass hose
- 3/8" connection

height: 35"
 overall projection: 10^{11/16}"
 flow rate: (tub filler) 4.5 gpm (handshower) 2.5 gpm



Polished Chrome **\$1695**
 Brushed Nickel **\$2195**
 Custom Finish **\$3390**

Easy-Fit™ adaptors give extra play room and snap when faucet is pushed down

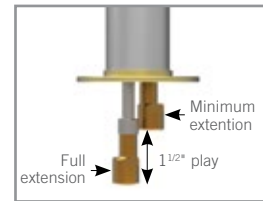

Easy-Fit™ adaptors included for an easy, fast and simple installation (see installation guide for details)

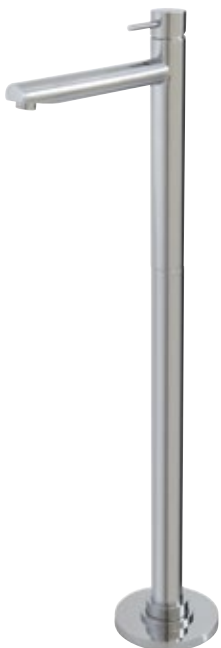

61085 floormount tub filler

- solid brass construction
- aerated water flow
- 3/8" connection

height: 34"
 overall projection: 11^{1/16}"
 flow rate: 5.5 gpm



Polished Chrome **\$1495**
 Brushed Nickel **\$1950**
 Custom Finish **\$2990**



MARMO

TOSCA

OTTO

VITTORIO

REGENCY

ETNA

CUT

VOLARE

**61024 single-hole bidet with swivel spray**

- solid brass construction
- mechanical drain included
- 20° swivel aerator
- 1/2" connection

height: 5^{7/8"}
 overall projection: 5^{5/8"}
 flow rate: 3 gpm



ABCA04075

Polished Chrome **\$395**
 Brushed Nickel **\$515**
 Custom Finish **\$790**



MB2

XROUND

GEO

TIME

BLOK

VOLARE

FOLIA

**61026 4 hole bidet set**

- solid brass construction
- incorporated vacuum breaker and vertical spray
- mechanical drain included
- 1/2" connection

height: 4^{11/16"}
 flow rate: full flow

ABCA30911 / HOT
ABCA30921 / COLD

Polished Chrome **\$1350**
 Brushed Nickel **\$1750**
 Custom Finish **\$2700**



MIDTOWN

MUST

BLADE

LOVEME

ALPHA

METRO

CHICANE

Shower Valves & Trim Set Solutions

(for complete program, see pages 241 - 292)

**R3061 plate and handle trim set**

- 4^{1/4"}x7^{7/8"}x1/8"
- requires #12000 TURBO thermostatic valve with a choice of a shut-off valve (#1206) or a 2-3 way diverter (#61934)

Polished Chrome **\$245**
 Brushed Nickel **\$320**
 Custom Finish **\$490**

T12000 TURBO thermostatic valve 3/4" - 1/2"

Rough **\$455**



B-JOU

MADISON

XSQUARE

STREEM

**R0695 plate and handle trim set**

- 3^{1/4"}x1/8"
- requires #1206 shut-off valve

Polished Chrome **\$130**
 Brushed Nickel **\$165**
 Custom Finish **\$260**

1206 TURBO 1/2" shut-off valve

Rough **\$165**

SOLO

DRAINS



2-way

93921 plate and handle trim set with 2-way diverter

• WITH STOP – shared functions

- replaces the functionality of 2 shut-off valves
- 2^{3/4}" x 1/8"
- requires #61934 diverter

Polished Chrome **\$245**
 Brushed Nickel **\$295**
 Custom Finish **\$490**

61934 2 & 3 way diverter

Rough **\$195**



2-way

93821 plate and handle trim set with 2-way diverter

• WITH STOP – 1 function at a time

- replaces the functionality of 2 shut-off valves
- 2^{3/4}" x 1/8"
- requires #61934 diverter

Polished Chrome **\$245**
 Brushed Nickel **\$295**
 Custom Finish **\$490**

61934 2 & 3 way diverter

Rough **\$195**



3-way

93931 plate and handle trim set with 3-way diverter

• WITH STOP – shared functions

- replaces the functionality of 3 shut-off valves
- 2^{3/4}" x 1/8"
- requires #61934 diverter

Polished Chrome **\$245**
 Brushed Nickel **\$295**
 Custom Finish **\$490**

61934 2 & 3 way diverter

Rough **\$195**



3-way

93831 plate and handle trim set with 3-way diverter

• WITH STOP – 1 function at a time

- replaces the functionality of 3 shut-off valves
- 2^{3/4}" x 1/8"
- requires #61934 diverter

Polished Chrome **\$245**
 Brushed Nickel **\$295**
 Custom Finish **\$490**

61934 2 & 3 way diverter

Rough **\$195**



R3161 plate and handle trim set

- 4^{1/4}" x 1 1/8" x 1/8"
- requires #12001 TURBO thermostatic valve

Polished Chrome **\$355**
 Brushed Nickel **\$465**
 Custom Finish **\$710**

T12001 TURBO thermostatic valve with 1 shut-off valve - 3/4" - 1/2"

Rough **\$625**



MARMO

TOSCA

OTTO

VITTORIO

REGENCY

ETNA

CUT

VOLARE

**R3261 plate and handle trim set**

- 4^{1/4}"x13^{3/4}"x1/8"
- requires # 12002 TURBO thermostatic valve

Polished Chrome **\$470**Brushed Nickel **\$615**Custom Finish **\$940****T12002 TURBO thermostatic valve with 2 shut-off valve - 3/4" - 1/2"**Rough **\$795****R3361 plate and handle trim set**

- 4^{1/4}"x16^{3/4}"x1/8"
- requires # 12003 TURBO thermostatic valve

Polished Chrome **\$590**Brushed Nickel **\$770**Custom Finish **\$1180****T12003 TURBO thermostatic valve with 3 shut-off valve - 3/4" - 1/2"**Rough **\$965****R3461 plate and handle trim set**

- 4^{1/4}"x19^{5/8}"x1/8"
- requires # 12004 TURBO thermostatic valve

Polished Chrome **\$720**Brushed Nickel **\$940**Custom Finish **\$1440****T12004 TURBO thermostatic valve with 4 shut-off valve - 3/4" - 1/2"**Rough **\$1135****R8261 plate and handle trim set with 2-way diverter**

- shared functions
- 4^{1/4}"x12"x1/8"
- requires #T12123 Turbo Uniplex thermostatic valve

Polished Chrome **\$445**Brushed Nickel **\$580**Custom Finish **\$890**

2-way

T12123 TURBO UNIPLEX thermostatic valve 3/4" - 1/2"Rough **\$495****R9261 plate and handle trim set with 2-way diverter**

- 1 function at a time
- 4^{1/4}"x12"x1/8"
- requires #T12123 Turbo Uniplex thermostatic valve

Polished Chrome **\$445**Brushed Nickel **\$580**Custom Finish **\$890**

2-way

T12123 TURBO UNIPLEX thermostatic valve 3/4" - 1/2"Rough **\$495**

MB2

XROUND

GEO

TIME

BLOK

VOLARE

FOLIA



MIDTOWN

MUST

BLADE

LOVEME

ALPHA

METRO

CHICANE



B-JOU

MADISON

XSQUARE

STREEM

SOLO

DRAINS



3-way

- R8361 plate and handle trim set with 3-way diverter**
- **shared functions**
 - 4^{1/4}"x12"x1/8"
 - requires #T12123 Turbo Uniplex thermostatic valve

Polished Chrome **\$445**
 Brushed Nickel **\$580**
 Custom Finish **\$890**

T12123 TURBO UNIPLEX thermostatic valve 3/4" - 1/2"

Rough **\$495**



3-way

- R9361 plate and handle trim set with 3-way diverter**
- **1 function at a time**
 - 4^{1/4}"x12"x1/8"
 - requires #T12123 Turbo Uniplex thermostatic valve

Polished Chrome **\$445**
 Brushed Nickel **\$580**
 Custom Finish **\$890**

T12123 TURBO UNIPLEX thermostatic valve 3/4" - 1/2"

Rough **\$495**



- R4095 plate and handle trim set**
- 8"x1/8"
 - requires #40255 pressure balance valve

Polished Chrome **\$135**
 Brushed Nickel **\$175**
 Custom Finish **\$270**

- 40255 1/2" pressure balance valve for shower**
- due to visible rough parts, select matching finish

Polished Chrome **\$235**
 Brushed Nickel **\$265**
 Custom Finish **\$470**



- R4295 plate and handle trim set**
- 8"x1/8"
 - requires #42355 pressure balance valve

Polished Chrome **\$165**
 Brushed Nickel **\$215**
 Custom Finish **\$330**

- 42355 1/2" pressure balance valve for tub / shower**
- due to visible rough parts, select matching finish

Polished Chrome **\$425**
 Brushed Nickel **\$485**
 Custom Finish **\$850**

FOLIA

AVAILABLE FINISH

electro black







MARMO

TOSCA

OTTO

VITTORIO

REGENCY

ETNA

CUT

FOLIA

18014 single-hole lavatory faucet

Electro Black

\$395

- solid brass construction
- crystal clear water flow
- press pop-up drain with overflow included
- 3/8" connection

height: 8^{1/8"}overall projection: 6^{11/16"}

flow rate: 1.75 gpm



ABCA18001



MB2

XROUND

GEO

TIME

BLOK

VOLARE

FOLIA

18020 tall single-hole lavatory faucet

Electro Black

\$525

- solid brass construction
- crystal clear water flow
- press pop-up drain with overflow included
- 3/8" connection

height: 12^{1/16"}overall projection: 8^{11/16"}

flow rate: 1.75 gpm



ABCA18001



MIDTOWN

MUST

BLADE

LOVEME

ALPHA

METRO

CHICANE

18016 widespread lavatory faucet

Electro Black

\$795

- solid brass construction
- crystal clear water flow
- press pop-up drain with overflow included
- 1/2" connection

height: 6^{1/8"}overall projection: 6^{3/8"}

flow rate: 1.75 gpm

ABCA18011 / HOT
ABCA18021 / COLD

B-JOU

MADISON

XSQUARE

STREEM

18018 4-piece deckmount tub filler with handshower

Electro Black

\$975

- solid brass construction
- crystal clear water flow
- handshower with 5' double-helix hidden hose
- pull-button diverter at back of spout
- 1/2" connection





height: 7^{13/16"}overall projection: 8^{3/4"}

flow rate: (tub filler) 9 gpm (handshower) 2.5 gpm

ABCA18011 / HOT
ABCA18021 / COLD

Shower Valves & Trim Set Solutions

(for complete program, see pages 241 - 292)

	R3061 plate and handle trim set Electro Black \$415 <ul style="list-style-type: none"> • 4^{1/4}"x7^{7/8}"x1/8" • requires # 12000 TURBO thermostatic valve with a choice of a shut-off valve (#1206) or a 2-3 way diverter (#61934)
	T12000 TURBO thermostatic valve 3/4" - 1/2" Rough \$455
	R0695 plate and handle trim set Electro Black \$225 <ul style="list-style-type: none"> • 3^{1/4}"x1/8" • requires # 1206 shut-off valve
	1206 TURBO 1/2" shut-off valve Rough \$165
	93921 plate and handle trim set with 2-way diverter Electro Black \$355 <ul style="list-style-type: none"> • WITH STOP – shared functions • replaces the functionality of 2 shut-off valves • 2^{3/4}"x1/8" • requires #61934 diverter
	61934 2 & 3 way diverter Rough \$195
	93821 plate and handle trim set with 2-way diverter Electro Black \$355 <ul style="list-style-type: none"> • WITH STOP – 1 function at a time • replaces the functionality of 2 shut-off valves • 2^{3/4}"x1/8" • requires #61934 diverter
	61934 2 & 3 way diverter Rough \$195



MARMO

TOSCA

OTTO

VITTORIO

REGENCY

ETNA

CUT

FOLIA



3-way

93931 plate and handle trim set with 3-way diverter

Electro Black

\$355**• WITH STOP – shared functions**

- replaces the functionality of 3 shut-off valves
- 2^{3/4}" x 1/8"
- requires #61934 diverter

61934 2 & 3 way diverter

Rough

\$195

3-way

93831 plate and handle trim set with 3-way diverter

Electro Black

\$355**• WITH STOP – 1 function at a time**

- replaces the functionality of 3 shut-off valves
- 2^{3/4}" x 1/8"
- requires #61934 diverter

61934 2 & 3 way diverter

Rough

\$195**R3161 plate and handle trim set**

Electro Black

\$620

- 4^{1/4}" x 11" x 1/8"
- requires #12001 TURBO thermostatic valve

T12001 TURBO thermostatic valve with 1 shut-off valve - 3/4" - 1/2"

Rough

\$625**R3261 plate and handle trim set**

Electro Black

\$820

- 4^{1/4}" x 13^{3/4}" x 1/8"
- requires #12002 TURBO thermostatic valve

T12002 TURBO thermostatic valve with 2 shut-off valve - 3/4" - 1/2"

Rough

\$795**R3361 plate and handle trim set**

Electro Black

\$1030

- 4^{1/4}" x 16^{3/4}" x 1/8"
- requires #12003 TURBO thermostatic valve

T12003 TURBO thermostatic valve with 3 shut-off valve - 3/4" - 1/2"

Rough

\$965

MB2

XROUND

GEO

TIME

BLOK

VOLARE

FOLIA



MIDTOWN

MUST

BLADE

LOVEME

ALPHA

METRO

CHICANE



B-JOU

MADISON

XSQUARE

STREEM

SOLO

DRAINS



R3461 plate and handle trim set
 • 4^{1/4}"x19^{5/8}"x1/8"
 • requires #12004 TURBO thermostatic valve

Electro Black **\$1240**

T12004 TURBO thermostatic valve with 4 shut-off valve - 3/4" - 1/2"

Rough **\$1135**



R8261 plate and handle trim set with 2-way diverter
 • shared functions
 • 4^{1/4}"x12"x1/8"
 • requires #T12123 Turbo Uniplex thermostatic valve

Electro Black **\$780**

T12123 TURBO UNIPLEX thermostatic valve 3/4" - 1/2"

Rough **\$495**

2-way



R9261 plate and handle trim set with 2-way diverter
 • 1 function at a time
 • 4^{1/4}"x12"x1/8"
 • requires #T12123 Turbo Uniplex thermostatic valve

Electro Black **\$780**

T12123 TURBO UNIPLEX thermostatic valve 3/4" - 1/2"

Rough **\$495**

2-way



R8361 plate and handle trim set with 3-way diverter
 • shared functions
 • 4^{1/4}"x12"x1/8"
 • requires #T12123 Turbo Uniplex thermostatic valve

Electro Black **\$780**

T12123 TURBO UNIPLEX thermostatic valve 3/4" - 1/2"

Rough **\$495**

3-way



R9361 plate and handle trim set with 3-way diverter
 • 1 function at a time
 • 4^{1/4}"x12"x1/8"
 • requires #T12123 Turbo Uniplex thermostatic valve

Electro Black **\$780**

T12123 TURBO UNIPLEX thermostatic valve 3/4" - 1/2"

Rough **\$495**

3-way



MARMO

TOSCA

OTTO

VITTORIO

REGENCY

ETNA

CUT

FOLIA



R4095 plate and handle trim set

Electro Black

\$235

- 8"x1/8"
- requires #40255 pressure balance valve

40255 1/2" pressure balance valve for shower

Electro Black

\$415

- due to visible rough parts, select matching finish



MB2

XROUND

GEO

TIME

BLOK

VOLARE

FOLIA



R4295 plate and handle trim set

Electro Black

\$290

- 8"x1/8"
- requires #42355 pressure balance valve

42355 1/2" pressure balance valve for tub / shower

Electro Black

\$745

- due to visible rough parts, select matching finish



MIDTOWN

MUST

BLADE

LOVEME

ALPHA

METRO

CHICANE



B-JOU

MADISON

X SQUARE

STREEM

SOLO

DRAINS



MARMO

TOSCA

OTTO

VITTORIO

REGENCY

ETNA

CUT



MB2

XROUND

GEO

TIME

BLOK

VOLARE

FOLIA



MIDTOWN

MUST

BLADE

LOVEME

ALPHA

METRO

CHICANE



B-JOU

MADISON

X SQUARE

STREEM

SOLO

DRAINS

MIDTOWN

AVAILABLE FINISHES

polished chrome



electro black



brushed gold PVD





MARMO

TOSCA

OTTO

VITTORIO

REGENCY

ETNA

CUT

MIDTOWN

15014 single-hole lavatory faucet



- solid brass construction
- crystal clear water flow
- press pop-up drain with overflow included
- 3/8" connection

height: 6^{3/8"}
 overall projection: 6^{13/16"}
 flow rate: 1.75 gpm



ABCA01500

Polished Chrome **\$365**
 Electro Black **\$475**
 Brushed Gold PVD **\$515**

15019 4" centerset lavatory faucet



- solid brass construction
- aerated water flow
- press pop-up drain with overflow included
- 1/2" connection

height: 4^{15/16"}
 overall projection: 6^{11/16"}
 flow rate: 1.75 gpm

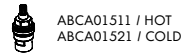
ABCA01511 / HOT
ABCA01521 / COLD

Polished Chrome **\$355**
 Electro Black **\$455**
 Brushed Gold PVD **\$495**

15016 widespread lavatory faucet



- solid brass construction
- crystal clear water flow
- press pop-up drain with overflow included
- 1/2" connection

height: 4^{3/4"}
 overall projection: 6^{5/8"}
 flow rate: 1.75 gpm

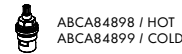
ABCA84898 / HOT
ABCA84899 / COLD

Polished Chrome **\$495**
 Electro Black **\$645**
 Brushed Gold PVD **\$695**

15084 Floormount tub filler with handshower



- solid brass construction
- crystal clear water flow
- handshower with 5' reinforced PVC hose
- pull-button diverter on the side of the spout
- 1/2" connection

height: 33^{1/4"}
 overall projection: 12^{11/16"}
 flow rate: (tub filler) 4.5 gpm
 (handshower) 2.5 gpm



ABCA84099

Polished Chrome **\$1395**
 Electro Black **\$1795**
 Brushed Gold PVD **\$1955**

Easy-Fit™ adaptors **included** for an easy, fast and simple installation (see installation guide for details)

Easy-Fit™ adaptors give extra play room and snap when faucet is pushed down

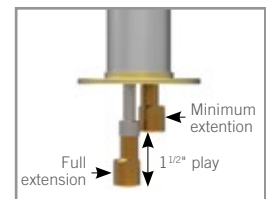

15018 4-piece deckmount tub filler with handshower



- solid brass construction
- crystal clear water flow
- handshower with 5' double-helix hidden hose
- pull-button diverter at the back of spout
- 1/2" connection

height: (w/ handshower) 5^{11/16"}
 overall projection: 8^{5/8"}
 flow rate: (tub filler) 9 gpm (handshower) 2.5 gpm

Polished Chrome **\$795**

Electro Black **\$995**

Brushed Gold PVD **\$1115**



ABCA84898 / HOT
 ABCA84899 / COLD

Shower Valves & Trim Set Solutions

(for complete program, see pages 241 - 292)



SR3095 plate and handle trim set

- 4^{1/4"}x7^{7/8"}x1/8"
- requires # 12000 TURBO thermostatic valve with a choice of a shut-off valve (# 1206) or a 2-3 way diverter (# 61934)

Polished Chrome **\$195**

Electro Black **\$340**

Brushed Gold **\$340**

T12000 TURBO thermostatic valve 3/4" - 1/2"

Rough **\$455**



SR0695 plate and handle trim set

- 3^{1/4"}x4^{1/4"}x1/8"
- requires # 1206 shut-off valve

Polished Chrome **\$160**

Electro Black **\$280**

Brushed Gold **\$280**

1206 1/2" shut-off valve

Rough **\$165**

93922 plate and handle trim set with 2-way diverter

- **WITH STOP – shared functions**
- replaces the functionality of 2 shut-off valves
- 2^{3/4"}x2^{3/4"}x1/8"
- requires # 61934 diverter

Polished Chrome **\$275**

Electro Black **\$395**

Brushed Gold **\$395**



2-way

61934 2 & 3 way diverter

Rough **\$195**





MARMO

TOSCA

OTTO

VITTORIO

REGENCY

ETNA

CUT

MIDTOWN



2-way

93822 plate and handle trim set with 2-way diverter

- **WITH STOP – 1 function at a time**
- replaces the functionality of 2 shut-off valves
- 2^{3/4}" x 2^{3/4}" x 1/8"
- requires # 61934 diverter

Polished Chrome **\$275**
 Electro Black **\$395**
 Brushed Gold **\$395**

61934 2 & 3 way diverter

Rough **\$195**



3-way

93932 plate and handle trim set with 3-way diverter

- **WITH STOP – shared functions**
- replaces the functionality of 3 shut-off valves
- 2^{3/4}" x 2^{3/4}" x 1/8"
- requires # 61934 diverter

Polished Chrome **\$275**
 Electro Black **\$395**
 Brushed Gold **\$395**

61934 2 & 3 way diverter

Rough **\$195**



3-way

93832 plate and handle trim set with 3-way diverter

- **WITH STOP – 1 function at a time**
- replaces the functionality of 3 shut-off valves
- 2^{3/4}" x 2^{3/4}" x 1/8"
- requires # 61934 diverter

Polished Chrome **\$275**
 Electro Black **\$395**
 Brushed Gold **\$395**

61934 2 & 3 way diverter

Rough **\$195**



SR3195 plate and handle trim set

- 4^{1/4}" x 1^{1/8}" x 1/8"
- requires # 12001 TURBO thermostatic valve

Polished Chrome **\$340**
 Electro Black **\$595**
 Brushed Gold **\$595**

T12001 TURBO thermostatic valve with 1 shut-off valve - 3/4" - 1/2"

Rough **\$625**



SR3295 plate and handle trim set

- 4^{1/4}" x 1^{3/4}" x 1^{1/8}"
- requires # 12002 TURBO thermostatic valve

Polished Chrome **\$490**
 Electro Black **\$850**
 Brushed Gold **\$850**

T12002 TURBO thermostatic valve with 2 shut-off valve - 3/4" - 1/2"

Rough **\$795**



MB2

XROUND

GEO

TIME

BLOK

VOLARE

FOLIA



MIDTOWN

MUST

BLADE

LOVEME

ALPHA

METRO

CHICANE



B-JOU

MADISON

XSQUARE

STREEM

SOLO

DRAINS



SR3395 plate and handle trim set
 • 4^{1/4}"x16^{3/4}"x1/8"
 • requires # 12003 TURBO thermostatic valve

Polished Chrome **\$645**
 Electro Black **\$1130**
 Brushed Gold **\$1130**

T12003 TURBO thermostatic valve with 3 shut-off valve - 3/4" - 1/2"

Rough **\$965**



SR3495 plate and handle trim set
 • 4^{1/4}"x19^{5/8}"x1/8"
 • requires # 12004 TURBO thermostatic valve

Polished Chrome **\$795**
 Electro Black **\$1385**
 Brushed Gold **\$1385**

T12004 TURBO thermostatic valve with 4 shut-off valve - 3/4" - 1/2"

Rough **\$1135**



2-way

SR8295 plate and handle trim set with 2-way diverter
 • shared functions
 • 4^{1/4}"x12"x1/8"
 • requires #T12123 Turbo Uniplex thermostatic valve

Polished Chrome **\$455**
 Electro Black **\$795**
 Brushed Gold **\$795**

T12123 TURBO UNIPLEX thermostatic valve 3/4" - 1/2"

Rough **\$495**



2-way

SR9295 plate and handle trim set with 2-way diverter
 • 1 function at a time
 • 4^{1/4}"x12"x1/8"
 • requires #T12123 Turbo Uniplex thermostatic valve

Polished Chrome **\$455**
 Electro Black **\$795**
 Brushed Gold **\$795**

T12123 TURBO UNIPLEX thermostatic valve 3/4" - 1/2"

Rough **\$495**



3-way

SR8395 plate and handle trim set with 3-way diverter
 • shared functions
 • 4^{1/4}"x12"x1/8"
 • requires #T12123 Turbo Uniplex thermostatic valve

Polished Chrome **\$455**
 Electro Black **\$795**
 Brushed Gold **\$795**

T12123 TURBO UNIPLEX thermostatic valve 3/4" - 1/2"

Rough **\$495**



MARMO

TOSCA

OTTO

VITTORIO

REGENCY

ETNA

CUT

MIDTOWN



3-way

- SR9395 plate and handle trim set with 3-way diverter**
- 1 function at a time
 - 4^{1/4}"x12"x1/8"
 - requires #T12123 Turbo Uniplex thermostatic valve

Polished Chrome **\$455**
 Electro Black **\$795**
 Brushed Gold **\$795**

T12123 TURBO UNIPLEX thermostatic valve 3/4" - 1/2"

Rough **\$495**



MB2

XROUND

GEO

TIME

BLOK

VOLARE

FOLIA



- SR4095 plate and handle trim set**
- 6^{1/2}"x8^{1/4}"x1/8"
 - requires #40255 pressure balance valve

Polished Chrome **\$165**
 Electro Black **\$285**
 Brushed Gold **\$285**

40255 1/2" pressure balance valve for shower

- due to visible rough parts, select matching finish

Polished Chrome **\$235**
 Electro Black **\$415**
 Brushed Gold **\$415**



- SR4295 plate and handle trim set**
- 6^{1/2}"x8^{1/4}"x1/8"
 - requires #42355 pressure balance valve

Polished Chrome **\$195**
 Electro Black **\$345**
 Brushed Gold **\$345**

42355 1/2" pressure balance valve for tub / shower

- due to visible rough parts, select matching finish

Polished Chrome **\$425**
 Electro Black **\$745**
 Brushed Gold **\$745**

MIDTOWN

MUST

BLADE

LOVEME

ALPHA

METRO

CHICANE



B-JOU

MADISON

XSQUARE

STREEM

SOLO

DRAINS



MARMO

TOSCA

OTTO

VITTORIO

REGENCY

ETNA

CUT



MB2

XROUND

GEO

TIME

BLOK

VOLARE

FOLIA



MIDTOWN

MUST

BLADE

LOVEME

ALPHA

METRO

CHICANE



B-JOU

MADISON

X SQUARE

STREEM

SOLO

DRAINS

MUST

AVAILABLE FINISHES

polished chrome



electro black

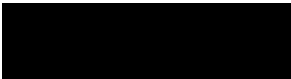





MARMO

TOSCA

OTTO

VITTORIO

REGENCY

ETNA

CUT

MUST

**56014 single-hole lavatory faucet**

- solid brass construction
- crystal clear water flow
- press pop-up drain with overflow included
- 3/8" connection

height: 6^{1/16"}
 overall projection: 7"
 flow rate: 2 gpm



ABCA56040

Polished Chrome **\$325**
 Electro Black **\$425**



MB2

XROUND

GEO

TIME

BLOK

VOLARE

FOLIA

**56020 tall single-hole lavatory faucet**

- solid brass construction
- crystal clear water flow
- press pop-up drain with overflow included
- 3/8" connection

height: 9^{15/16"}
 overall projection: 7"
 flow rate: 2 gpm



ABCA56040

Polished Chrome **\$475**
 Electro Black **\$615**



MIDTOWN

MUST

BLADE

LOVEME

ALPHA

METRO

CHICANE

**56074 2-piece deckmount tub filler with handshower**

- solid brass construction
- concealed aerator – crystal clear water flow
- handshower with 5' double-helix hidden hose
- pull-button diverter on front of spout
- 1/2" female connections

height: 8^{1/4"}
 overall projection: 10^{11/16"}
 flow rate: (tub filler) 5.5 gpm (handshower) 2 gpm



ABCA56084

Polished Chrome **\$695**
 Electro Black **\$895**



B-JOU

MADISON

XSQUARE

STREEM

SOLO

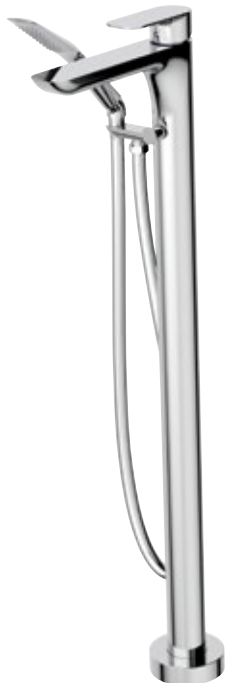
**56084 floormount tub filler with handshower**

- solid brass construction
- crystal clear water flow
- handshower with 5' reinforced PVC hose
- pull-button diverter in front of the spout
- 1/2" connection

height: 36^{5/8"}
 overall projection: 11^{9/16"}
 flow rate (tub filler): 5 gpm
 (handshower): 2 gpm



ABCA56084

Polished Chrome **\$1295**
 Electro Black **\$1685**

Easy-Fit™ adaptors give extra play room and snap when faucet is pushed down

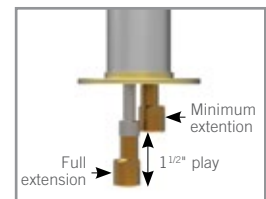

Easy-Fit™ adaptors included for an easy, fast and simple installation (see installation guide for details)

56032 wallmount tub spout

- solid brass construction
- crystal clear water flow
- non diverter spout
- 1/2" NPT male connection

 height: 2^{3/16}"

 overall projection: 7^{5/8}"

flow rate: depends on capacity of the valve

 Polished Chrome **\$195**

 Electro Black **\$245**

Shower Valves & Trim Set Solutions

(for complete program, see pages 241 - 292)

SR3095 plate and handle trim set

- 4^{1/4}"x7^{7/8}"x1/8"
- requires # 12000 TURBO thermostatic valve with a choice of a shut-off valve (# 1206) or a 2-3 way diverter (# 61934)

 Polished Chrome **\$195**

 Electro Black **\$340**
T12000 TURBO thermostatic valve 3/4" - 1/2"

 Rough **\$455**

SR0695 plate and handle trim set

- 3^{1/4}"x4^{1/4}"x1/8"
- requires # 1206 shut-off valve

 Polished Chrome **\$160**

 Electro Black **\$280**
1206 1/2" shut-off valve

 Rough **\$165**

2-way

93922 plate and handle trim set with 2-way diverter

- **WITH STOP – shared functions**
- replaces the functionality of 2 shut-off valves
- 2^{3/4}" x 2^{3/4}" x 1/8"
- requires # 61934 diverter

 Polished Chrome **\$275**

 Electro Black **\$395**
61934 2 & 3 way diverter

 Rough **\$195**



MARMO

TOSCA

OTTO

VITTORIO

REGENCY

ETNA

CUT

MUST



2-way

93822 plate and handle trim set with 2-way diverter

- **WITH STOP – 1 function at a time**
- replaces the functionality of 2 shut-off valves
- 2^{3/4}" x 2^{3/4}" x 1/8"
- requires # 61934 diverter

Polished Chrome **\$275**
Electro Black **\$395**

61934 2 & 3 way diverter

Rough **\$195**



3-way

93932 plate and handle trim set with 3-way diverter

- **WITH STOP – shared functions**
- replaces the functionality of 3 shut-off valves
- 2^{3/4}" x 2^{3/4}" x 1/8"
- requires # 61934 diverter

Polished Chrome **\$275**
Electro Black **\$395**

61934 2 & 3 way diverter

Rough **\$195**



3-way

93832 plate and handle trim set with 3-way diverter

- **WITH STOP – 1 function at a time**
- replaces the functionality of 3 shut-off valves
- 2^{3/4}" x 2^{3/4}" x 1/8"
- requires # 61934 diverter

Polished Chrome **\$275**
Electro Black **\$395**

61934 2 & 3 way diverter

Rough **\$195**

**SR3195 plate and handle trim set**

- 4^{1/4}" x 1 1/8" x 1/8"
- requires # 12001 TURBO thermostatic valve

Polished Chrome **\$340**
Electro Black **\$595**

T12001 TURBO thermostatic valve with 1 shut-off valve - 3/4" - 1/2"

Rough **\$625**

**SR3295 plate and handle trim set**

- 4^{1/4}" x 1 3/4" x 1/8"
- requires # 12002 TURBO thermostatic valve

Polished Chrome **\$490**
Electro Black **\$850**

T12002 TURBO thermostatic valve with 2 shut-off valve - 3/4" - 1/2"

Rough **\$795**



MB2

XROUND

GEO

TIME

BLOK

VOLARE

FOLIA



MIDTOWN

MUST

BLADE

LOVEME

ALPHA

METRO

CHICANE



B-JOU

MADISON

XSQUARE

STREEM

SOLO

DRAINS



MUST

MARMO

TOSCA

OTTO

VITTORIO

REGENCY

ETNA

CUT



MB2

XROUND

GEO

TIME

BLOK

VOLARE

FOLIA



MIDTOWN

MUST

BLADE

LOVEME

ALPHA

METRO

CHICANE



B-JOU

MADISON

XSQUARE

STREAM

SOLO

DRAINS



SR3395 plate and handle trim set
 • 4^{1/4}"x16^{3/4}"x1/8"
 • requires # 12003 TURBO thermostatic valve

Polished Chrome **\$645**
 Electro Black **\$1130**

T12003 TURBO thermostatic valve with 3 shut-off valve - 3/4" - 1/2"

Rough **\$965**



SR3495 plate and handle trim set
 • 4^{1/4}"x19^{5/8}"x1/8"
 • requires # 12004 TURBO thermostatic valve

Polished Chrome **\$795**
 Electro Black **\$1385**

T12004 TURBO thermostatic valve with 4 shut-off valve - 3/4" - 1/2"

Rough **\$1135**



2-way

SR8295 plate and handle trim set with 2-way diverter
 • shared functions
 • 4^{1/4}"x12"x1/8"
 • requires #T12123 Turbo Uniplex thermostatic valve

Polished Chrome **\$455**
 Electro Black **\$795**

T12123 TURBO UNIPLEX thermostatic valve 3/4" - 1/2"

Rough **\$495**



2-way

SR9295 plate and handle trim set with 2-way diverter
 • 1 function at a time
 • 4^{1/4}"x12"x1/8"
 • requires #T12123 Turbo Uniplex thermostatic valve

Polished Chrome **\$455**
 Electro Black **\$795**

T12123 TURBO UNIPLEX thermostatic valve 3/4" - 1/2"

Rough **\$495**



3-way

SR8395 plate and handle trim set with 3-way diverter
 • shared functions
 • 4^{1/4}"x12"x1/8"
 • requires #T12123 Turbo Uniplex thermostatic valve

Polished Chrome **\$455**
 Electro Black **\$795**

T12123 TURBO UNIPLEX thermostatic valve 3/4" - 1/2"

Rough **\$495**



MARMO

TOSCA

OTTO

VITTORIO

REGENCY

ETNA

CUT

MUST



3-way

- SR9395 plate and handle trim set with 3-way diverter**
- 1 function at a time
 - 4^{1/4"}x12"x1/8"
 - requires #T12123 Turbo Uniplex thermostatic valve

Polished Chrome **\$455**
Electro Black **\$795**

T12123 TURBO UNIPLEX thermostatic valve 3/4" - 1/2"

Rough **\$495**



MB2

XROUND

GEO

TIME

BLOK

VOLARE

FOLIA



- SR4095 plate and handle trim set**
- 6^{1/2"}x8^{1/4"}x1/8"
 - requires #40255 pressure balance valve

Polished Chrome **\$165**
Electro Black **\$285**

- 40255 1/2" pressure balance valve for shower**
- due to visible rough parts, select matching finish

Polished Chrome **\$235**
Electro Black **\$415**



MIDTOWN

MUST

BLADE

LOVEME

ALPHA

METRO

CHICANE



- SR4295 plate and handle trim set**
- 6^{1/2"}x8^{1/4"}x1/8"
 - requires #42355 pressure balance valve

Polished Chrome **\$195**
Electro Black **\$345**

- 42355 1/2" pressure balance valve for tub / shower**
- due to visible rough parts, select matching finish

Polished Chrome **\$425**
Electro Black **\$745**



B-JOU

MADISON

XSQUARE

STREEM

SOLO

DRAINS



MARMO

TOSCA

OTTO

VITTORIO

REGENCY

ETNA

CUT



MB2

XROUND

GEO

TIME

BLOK

VOLARE

FOLIA



MIDTOWN

MUST

BLADE

LOVEME

ALPHA

METRO

CHICANE



B-JOU

MADISON

X SQUARE

STREEM

SOLO

DRAINS

BLADE

AVAILABLE FINISHES

polished chrome



brushed nickel



electro black

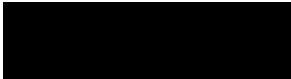

brushed gold



 BLADE collection is also available
in Aquabross' custom finishes
(10 weeks lead time, see finish chart p.vii)







MARMO

TOSCA

OTTO

VITTORIO

REGENCY

ETNA

CUT



MB2

XROUND

GEO

TIME

BLOK

VOLARE

FOLIA



MIDTOWN

MUST

BLADE

LOVEME

ALPHA

METRO

CHICANE



B-JOU

MADISON

XSQUARE

STREEM

SOLO

DRAINS

BLADE



68014 single-hole lavatory faucet

- solid brass construction
- aerated water flow
- press pop-up drain with overflow included
- 3/8" connection

height: 5^{7/8}"
overall projection: 6"
flow rate: 1.5 gpm



ABCA04075

Polished Chrome **\$325**
Brushed Nickel **\$425**
Electro Black **\$565**
Brushed Gold **\$565**
Custom Finish **\$650**



68020 tall single-hole lavatory faucet

- solid brass construction
- aerated water flow
- press pop-up drain with overflow included
- 3/8" connection

height: 13^{1/16}"
overall projection: 8^{7/16}"
flow rate: 1.5 gpm



ABCA04075

Polished Chrome **\$475**
Brushed Nickel **\$615**
Electro Black **\$835**
Brushed Gold **\$835**
Custom Finish **\$950**



68016 widespread lavatory faucet

- solid brass construction
- aerated water flow
- press pop-up drain with overflow included
- 1/2" connection

height: 9^{11/16}"
overall projection: 6^{5/8}"
flow rate: 1.5 gpm

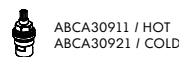
ABCA30911 / HOT
ABCA30921 / COLD

Polished Chrome **\$525**
Brushed Nickel **\$685**
Electro Black **\$895**
Brushed Gold **\$895**
Custom Finish **\$1050**



68029 wallmount 8" c.c. lavatory faucet

- solid brass construction
- aerated water flow
- drain not included, see page 212 for options
- rough-in not included, order # **83029**

height: 3^{3/8}"
overall projection: 8"
flow rate: 2.2 gpm

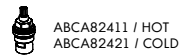
ABCA82411 / HOT
ABCA82421 / COLD

Polished Chrome **\$425**
Brushed Nickel **\$555**
Electro Black **\$745**
Brushed Gold **\$745**
Custom Finish **\$850**



83029 rough-in for wallmount faucet #68029

- 1/2" NPT connection

Rough-in **\$195**

BLADE

- ∞
- MARMO
- TOSCA
- OTTO
- VITTORIO
- REGENCY
- ETNA
- CUT

-
- MB2
- XROUND
- GEO
- TIME
- BLOK
- VOLARE
- FOLIA

- ◻
- MIDTOWN
- MUST
- BLADE**
- LOVEME
- ALPHA
- METRO
- CHICANE

- ◻
- B-JOU
- MADISON
- X SQUARE
- STREAM

- SOLO

- DRAINS

68012 2-piece lavatory faucet with side joystick



- solid brass construction
- aerated water flow
- single volume and temperature side joystick control
- press pop-up drain with overflow included
- 3/8" connection

height: 9^{11/16"}
 overall projection: 7^{5/8"}
 flow rate: 1.5 gpm



- Polished Chrome **\$595**
- Brushed Nickel **\$775**
- Electro Black **\$995**
- Brushed Gold **\$995**
- ✦ Custom Finish **\$1190**

68N84 floormount tub filler with handshower



- solid brass construction
- aerated water flow
- handshower with 5' reinforced PVC hose
- pull-button diverter in front of the spout
- 1/2" connection

height: 38^{15/16"}
 overall projection: 12^{5/8"}
 flow rate: (tub filler) 5.5 gpm
 (handshower) 2.5 gpm



- Polished Chrome **\$1295**
- Brushed Nickel **\$1685**
- Electro Black **\$2250**
- Brushed Gold **\$2250**
- ✦ Custom Finish **\$2590**

Easy-Fit™ adaptors give extra play room and snap when faucet is pushed down

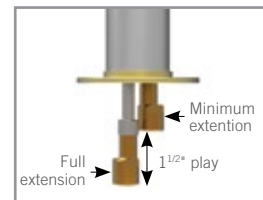

Easy-Fit™ adaptors included for an easy, fast and simple installation (see installation guide for details)

68024 single-hole bidet with swivel spray



- solid brass construction
- mechanical drain included
- 20° swivel aerator
- 1/2" connection

height: 5^{3/4"}
 overall projection: 5^{5/8"}
 flow rate: 3 gpm

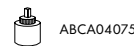

- Polished Chrome **\$395**
- Brushed Nickel **\$515**
- Electro Black **\$690**
- Brushed Gold **\$690**
- ✦ Custom Finish **\$790**

68026 4 hole bidet set



- solid brass construction
- incorporated vacuum breaker & vertical spray
- mechanical drain included
- 1/2" connection

height: 4^{11/16"}
 flow rate: full flow

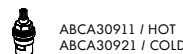

- Polished Chrome **\$1350**
- Brushed Nickel **\$1750**
- Electro Black **\$2350**
- Brushed Gold **\$2350**
- ✦ Custom Finish **\$2700**



MARMO

TOSCA

OTTO

VITTORIO

REGENCY

ETNA

CUT

BLADE

Shower Valves & Trim Set Solutions

(for complete program, see pages 241 - 292)



R3095 plate and handle trim set

- 4^{1/4}"x7^{7/8}"x1/8"
- requires #12000 TURBO thermostatic valve with a choice of a shut-off valve (#1206) or a 2-3 way diverter (#61934)

Polished Chrome	\$150
Brushed Nickel	\$195
Electro Black	\$250
Brushed Gold	\$250
✦ Custom Finish	\$300

T12000 TURBO thermostatic valve 3/4" - 1/2"

Rough	\$455
-------	--------------



R0695 plate and handle trim set

- 3^{1/4}"x1/8"
- requires #1206 shut-off valve

Polished Chrome	\$130
Brushed Nickel	\$165
Electro Black	\$225
Brushed Gold	\$225
✦ Custom Finish	\$260

1206 TURBO 1/2" shut-off valve

Rough	\$165
-------	--------------



2-way

93921 plate and handle trim set with 2-way diverter

- **WITH STOP – shared functions**
- replaces the functionality of 2 shut-off valves
- 2^{3/4}" x1/8"
- requires #61934 diverter

Polished Chrome	\$245
Brushed Nickel	\$295
Electro Black	\$355
Brushed Gold	\$355
✦ Custom Finish	\$490

61934 2 & 3 way diverter

Rough	\$195
-------	--------------



2-way

93821 plate and handle trim set with 2-way diverter

- **WITH STOP – 1 function at a time**
- replaces the functionality of 2 shut-off valves
- 2^{3/4}" x1/8"
- requires #61934 diverter

Polished Chrome	\$245
Brushed Nickel	\$295
Electro Black	\$355
Brushed Gold	\$355
✦ Custom Finish	\$490

61934 2 & 3 way diverter

Rough	\$195
-------	--------------

SOLO

DRAINS

BLADE

LOVEME

ALPHA

METRO

CHICANE



B-JOU

MADISON

XSQUARE

STREEM

MIDTOWN

MUST

BLADE

LOVEME

ALPHA

METRO

CHICANE



B-JOU

MADISON

XSQUARE

STREEM

SOLO

DRAINS



3-way

93931 plate and handle trim set with 3-way diverter

• WITH STOP – shared functions

- replaces the functionality of 3 shut-off valves
- 2^{3/4}" x 1/8"
- requires #61934 diverter

Polished Chrome **\$245**

Brushed Nickel **\$295**

Electro Black **\$355**

Brushed Gold **\$355**

✦ Custom Finish **\$490**

61934 2 & 3 way diverter

Rough **\$195**



3-way

93831 plate and handle trim set with 3-way diverter

• WITH STOP – 1 function at a time

- replaces the functionality of 3 shut-off valves
- 2^{3/4}" x 1/8"
- requires #61934 diverter

Polished Chrome **\$245**

Brushed Nickel **\$295**

Electro Black **\$355**

Brushed Gold **\$355**

✦ Custom Finish **\$490**

61934 2 & 3 way diverter

Rough **\$195**



R3195 plate and handle trim set

- 4^{1/4}" x 1 1/8" x 1/8"
- requires #12001 TURBO thermostatic valve

Polished Chrome **\$260**

Brushed Nickel **\$340**

Electro Black **\$455**

Brushed Gold **\$455**

✦ Custom Finish **\$520**

T12001 TURBO thermostatic valve with 1 shut-off valve - 3/4" - 1/2"

Rough **\$625**



R3295 plate and handle trim set

- 4^{1/4}" x 1 3/4" x 1/8"
- requires #12002 TURBO thermostatic valve

Polished Chrome **\$375**

Brushed Nickel **\$490**

Electro Black **\$655**

Brushed Gold **\$655**

✦ Custom Finish **\$750**

T12002 TURBO thermostatic valve with 2 shut-off valve - 3/4" - 1/2"

Rough **\$795**



R3395 plate and handle trim set

- 4^{1/4}" x 1 6/8" x 1/8"
- requires #12003 TURBO thermostatic valve

Polished Chrome **\$495**

Brushed Nickel **\$695**

Electro Black **\$865**

Brushed Gold **\$865**

✦ Custom Finish **\$990**

T12003 TURBO thermostatic valve with 3 shut-off valve - 3/4" - 1/2"

Rough **\$965**



MARMO

TOSCA

OTTO

VITTORIO

REGENCY

ETNA

CUT



MB2

XROUND

GEO

TIME

BLOK

VOLARE

FOLIA



MIDTOWN

MUST

BLADE

LOVEME

ALPHA

METRO

CHICANE



B-JOU

MADISON

XSQUARE

STREEM

SOLO

DRAINS

BLADE



R3495 plate and handle trim set

- 4^{1/4}"x19^{5/8}"x1/8"
- requires #12004 TURBO thermostatic valve

Polished Chrome	\$625
Brushed Nickel	\$815
Electro Black	\$1075
Brushed Gold	\$1075

Custom Finish **\$1250**

T12004 TURBO thermostatic valve with 4 shut-off valve - 3/4" - 1/2"

Rough **\$1135**



2-way

R8295 plate and handle trim set with 2-way diverter

- shared functions
- 4^{1/4}"x12"x1/8"
- requires #T12123 Turbo Uniplex thermostatic valve

Polished Chrome	\$350
Brushed Nickel	\$455
Electro Black	\$615
Brushed Gold	\$615

Custom Finish **\$700**

T12123 TURBO UNIPLEX thermostatic valve 3/4" - 1/2"

Rough **\$495**



2-way

R9295 plate and handle trim set with 2-way diverter

- 1 function at a time
- 4^{1/4}"x12"x1/8"
- requires #T12123 Turbo Uniplex thermostatic valve

Polished Chrome	\$350
Brushed Nickel	\$455
Electro Black	\$615
Brushed Gold	\$615

Custom Finish **\$700**

T12123 TURBO UNIPLEX thermostatic valve 3/4" - 1/2"

Rough **\$495**



3-way

R8395 plate and handle trim set with 3-way diverter

- shared functions
- 4^{1/4}"x12"x1/8"
- requires #T12123 Turbo Uniplex thermostatic valve

Polished Chrome	\$350
Brushed Nickel	\$455
Electro Black	\$615
Brushed Gold	\$615

Custom Finish **\$700**

T12123 TURBO UNIPLEX thermostatic valve 3/4" - 1/2"

Rough **\$495**



3-way

R9395 plate and handle trim set with 3-way diverter

- 1 function at a time
- 4^{1/4}"x12"x1/8"
- requires #T12123 Turbo Uniplex thermostatic valve

Polished Chrome	\$350
Brushed Nickel	\$455
Electro Black	\$615
Brushed Gold	\$615

Custom Finish **\$700**

T12123 TURBO UNIPLEX thermostatic valve 3/4" - 1/2"

Rough **\$495**

R4095 plate and handle trim set

- 8"x1/8"
- requires #40255 pressure balance valve

 Polished Chrome **\$135**

 Brushed Nickel **\$175**

 Electro Black **\$235**

 Brushed Gold **\$235**

 Custom Finish **\$270**
40255 1/2" pressure balance valve for shower

- due to visible rough parts, select matching finish

 Polished Chrome **\$235**

 Brushed Nickel **\$265**

 Electro Black **\$415**

 Brushed Gold **\$415**

 Custom Finish **\$470**
R4295 plate and handle trim set

- 8"x1/8"
- requires #42355 pressure balance valve

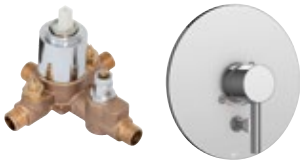
 Polished Chrome **\$165**

 Brushed Nickel **\$215**

 Electro Black **\$290**

 Brushed Gold **\$290**

 Custom Finish **\$330**
42355 1/2" pressure balance valve for tub / shower

- due to visible rough parts, select matching finish

 Polished Chrome **\$425**

 Brushed Nickel **\$485**

 Electro Black **\$745**

 Brushed Gold **\$745**

 Custom Finish **\$850**

LOVEME

AVAILABLE FINISH

polished chrome







MARMO

TOSCA

OTTO

VITTORIO

REGENCY

ETNA

CUT



MB2

XROUND

GEO

TIME

BLOK

VOLARE

FOLIA



MIDTOWN

MUST

BLADE

LOVEME

ALPHA

METRO

CHICANE



B-JOU

MADISON

X SQUARE

STREEM

SOLO

DRAINS

LOVEME



32044 short single-hole lavatory faucet

Polished Chrome

\$495

- solid brass construction
- cascading water flow
- single volume and temperature joystick control
- press pop-up drain with overflow included
- 3/8" connection

height: 7^{1/8"}

overall projection: 4^{5/8"}

flow rate: 2.2 gpm



ABCA11012



32014 single-hole lavatory faucet

Polished Chrome

\$895

- solid brass construction
- cascading water flow
- single volume and temperature joystick control
- press pop-up drain with overflow included
- 3/8" connection

height: 7"

overall projection: 5^{1/4"}

flow rate: 2.2 gpm



ABCA03240



32015 medium single-hole lavatory faucet

Polished Chrome

\$1095

- solid brass construction
- cascading water flow
- single volume and temperature joystick control
- press pop-up drain with overflow included
- 3/8" connection

height: 9"

overall projection: 5^{7/8"}

flow rate: 2.2 gpm



ABCA03240



32020 tall single-hole lavatory faucet

Polished Chrome

\$1295

- solid brass construction
- cascading water flow
- single volume and temperature joystick control
- press pop-up drain with overflow included
- 3/8" connection

height: 14"

overall projection: 5^{15/16"}

flow rate: 2.2 gpm



ABCA03240

32N29 wallmount lavatory faucet

Polished Chrome **\$1095**



- solid brass construction
- cascading water flow
- single volume and temperature joystick control
- drain not included, see page 212 for options
- rough-in not included, order # **CB029**

height: (w/ plate) 4^{3/8}"
 overall projection: 5^{1/2}"
 flow rate: 2.2 gpm



CB029 rough-in for wallmount faucet #32N29

Rough-in **\$295**



- 1/2" NPT connection

32074 2-piece deckmount tub filler with handshower

Polished Chrome **\$2995**



- solid brass construction
- cascading water flow
- single volume and temperature joystick control
- handshower with 5' double-helix hidden hose
- 1/2" connection

height: 8"
 overall projection: 7^{3/4}"
 flow rate: (tub filler) 10.5 gpm (handshower) 2.5 gpm



32013 3-piece deckmount tub filler with handshower

Polished Chrome **\$2795**



- solid brass construction
- cascading water flow
- pressure balance volume control mixing valve
- handshower with 5' double-helix hidden hose
- 1/2" connection

height: 8"
 overall projection: 5^{1/4}"
 flow rate: (tub filler) 5.5 gpm (handshower) 2.5 gpm



32004 wallmount tub filler with handshower

Polished Chrome **\$1895**



- solid brass construction
- cascading water flow
- single volume and temperature joystick control
- handshower with 5' reinforced pvc hose
- 1/2" NPT male connection

height: 8^{1/2}"
 overall projection: 5^{1/2}"
 flow rate: (tub filler) 5 gpm (handshower) 2.5 gpm

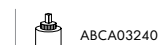



MARMO

TOSCA

OTTO

VITTORIO

REGENCY

ETNA

CUT



MB2

XROUND

GEO

TIME

BLOK

VOLARE

FOLIA



MIDTOWN

MUST

BLADE

LOVEME

ALPHA

METRO

CHICANE



B-JOU

MADISON

XSQUARE

STREEM

SOLO

DRAINS

LOVEME



32085 floormount tub filler with handshower

Polished Chrome

\$3795

- solid brass construction
- cascading water flow
- single volume and temperature joystick control
- handshower with 5' reinforced pvc hose
- 1/2" NPT male connection

height: 36^{1/4"}

overall projection: 11"

flow rate: (tub filler) 7 gpm

(handshower) 2.5 gpm



ABCA03240

Shower Valves & Trim Set Solutions

(for complete program, see pages 241 - 292)



SR3095 plate and handle trim set

Polished Chrome

\$195

- 4^{1/4"}x7^{7/8"}x1/8"
- requires #12000 TURBO thermostatic valve with a choice of a shut-off valve (#1206) or a 2-3 way diverter (#61934)

T12000 TURBO thermostatic valve 3/4" - 1/2"

Rough

\$455

SR0695 plate and handle trim set

Polished Chrome

\$160

- 3^{1/4"}x4^{1/4"}x1/8"
- requires #1206 shut-off valve

1206 1/2" shut-off valve

Rough

\$165



2-way

93922 plate and handle trim set with 2-way diverter

Polished Chrome **\$275**

• **WITH STOP – shared functions**

- replaces the functionality of 2 shut-off valves
- 2^{3/4"} x 2^{3/4"} x 1/8"
- requires #61934 diverter

61934 2 & 3 way diverter

Rough **\$195**



2-way

93822 plate and handle trim set with 2-way diverter

Polished Chrome **\$275**

• **WITH STOP – 1 function at a time**

- replaces the functionality of 2 shut-off valves
- 2^{3/4"} x 2^{3/4"} x 1/8"
- requires #61934 diverter

61934 2 & 3 way diverter

Rough **\$195**



3-way

93932 plate and handle trim set with 3-way diverter

Polished Chrome **\$275**

• **WITH STOP – shared functions**

- replaces the functionality of 3 shut-off valves
- 2^{3/4"} x 2^{3/4"} x 1/8"
- requires #61934 diverter

61934 2 & 3 way diverter

Rough **\$195**



3-way

93832 plate and handle trim set with 3-way diverter

Polished Chrome **\$275**

• **WITH STOP – 1 function at a time**

- replaces the functionality of 3 shut-off valves
- 2^{3/4"} x 2^{3/4"} x 1/8"
- requires #61934 diverter

61934 2 & 3 way diverter

Rough **\$195**



SR3195 plate and handle trim set

Polished Chrome **\$340**

- 4^{1/4"} x 11" x 1/8"
- requires #12001 TURBO thermostatic valve

T12001 TURBO thermostatic valve with 1 shut-off valve - 3/4" - 1/2"

Rough **\$625**



MARMO

TOSCA

OTTO

VITTORIO

REGENCY

ETNA

CUT

LOVEME



SR3295 plate and handle trim set
 • 4^{1/4}"x13^{3/4}"x1/8"
 • requires #12002 TURBO thermostatic valve

Polished Chrome **\$490**

T12002 TURBO thermostatic valve with 2 shut-off valve - 3/4" - 1/2"

Rough **\$795**



SR3395 plate and handle trim set
 • 4^{1/4}"x16^{3/4}"x1/8"
 • requires #12003 TURBO thermostatic valve

Polished Chrome **\$645**

T12003 TURBO thermostatic valve with 3 shut-off valve - 3/4" - 1/2"

Rough **\$965**



SR3495 plate and handle trim set
 • 4^{1/4}"x19^{5/8}"x1/8"
 • requires #12004 TURBO thermostatic valve

Polished Chrome **\$795**

T12004 TURBO thermostatic valve with 4 shut-off valve - 3/4" - 1/2"

Rough **\$1135**



2-way

SR8295 plate and handle trim set with 2-way diverter
 • shared functions
 • 4^{1/4}"x12"x1/8"
 • requires #T12123 Turbo Uniplex thermostatic valve

Polished Chrome **\$350**

T12123 TURBO UNIPLEX thermostatic valve 3/4" - 1/2"

Rough **\$495**



2-way

SR9295 plate and handle trim set with 2-way diverter
 • 1 function at a time
 • 4^{1/4}"x12"x1/8"
 • requires #T12123 Turbo Uniplex thermostatic valve

Polished Chrome **\$350**

T12123 TURBO UNIPLEX thermostatic valve 3/4" - 1/2"

Rough **\$495**

DRAINS

SOLO

STREEM

XSQUARE

MADISON

B-JOU



CHICANE

METRO

ALPHA

LOVEME

BLADE

MUST

MIDTOWN



FOLIA

VOLARE

BLOK

TIME

GEO

XROUND

MB2





3-way

SR8395 plate and handle trim set with 3-way diverter
 - shared functions
 - 4^{1/4}"x12"x1/8"
 - requires #T12123 Turbo Uniplex thermostatic valve

Polished Chrome **\$350**

T12123 TURBO UNIPLEX thermostatic valve 3/4" - 1/2"

Rough **\$495**



3-way

SR9395 plate and handle trim set with 3-way diverter
 - 1 function at a time
 - 4^{1/4}"x12"x1/8"
 - requires #T12123 Turbo Uniplex thermostatic valve

Polished Chrome **\$350**

T12123 TURBO UNIPLEX thermostatic valve 3/4" - 1/2"

Rough **\$495**



SR4095 plate and handle trim set
 - 6^{1/2}"x8^{1/4}"x1/8"
 - requires #40255 pressure balance valve

Polished Chrome **\$165**

40255 1/2" pressure balance valve for shower
 - due to visible rough parts, select matching finish

Polished Chrome **\$235**



SR4295 plate and handle trim set
 - 6^{1/2}"x8^{1/4}"x1/8"
 - requires #42355 pressure balance valve

Polished Chrome **\$195**

42355 1/2" pressure balance valve for tub / shower
 - due to visible rough parts, select matching finish

Polished Chrome **\$425**

ALPHA

AVAILABLE FINISHES

polished chrome



brushed nickel





AGGA
SEAL



MARMO

TOSCA

OTTO

VITTORIO

REGENCY

ETNA

CUT

ALPHA

92014 single-hole lavatory faucet

- solid brass construction
- crystal clear water flow
- press pop-up drain with overflow included
- 3/8" connection

height: 5^{1/4}"
 overall projection: 6^{5/8}"
 flow rate: 2 gpm



ABCA92098

Polished Chrome **\$525**
 Brushed Nickel **\$685**

92020 tall single-hole lavatory faucet

- solid brass construction
- crystal clear water flow
- press pop-up drain with overflow included
- 3/8" connection

height: 7^{1/2}"
 overall projection: 8^{1/8}"
 flow rate: 2 gpm



ABCA92098

Polished Chrome **\$750**
 Brushed Nickel **\$975**

92064 touchless single-hole lavatory faucet

- **mixer required (not included)**
- solid brass construction
- crystal clear water flow
- press pop-up drain with overflow included
- 3/8" connection

height: 4^{1/8}"
 overall projection: 6^{5/8}"
 flow rate: 2 gpm

Polished Chrome **\$995**
 Brushed Nickel **\$1295**

92N29 wallmount lavatory faucet

- solid brass construction
- crystal clear water flow
- drain not included, see page 212 for options
- rough-in not included, order # **CB329**

height: (w/ plate) 3^{15/16}"
 overall projection: 10^{5/16}"
 flow rate: 2 gpm



ABCA92097



ABSPEX3M29

Polished Chrome **\$695**
 Brushed Nickel **\$895**

CB329 rough-in for wallmount faucet #92N29

- 1/2" NPT male connection

Rough-in **\$295**



MB2

XROUND

GEO

TIME

BLOK

VOLARE

FOLIA



MIDTOWN

MUST

BLADE

LOVEME

ALPHA

METRO

CHICANE



B-JOU

MADISON

XSQUARE

STREEM

SOLO

92017 deckmount tub filler with handshower and 2 mixers

 Polished Chrome **\$2150**
 Brushed Nickel **\$2795**

- solid brass construction
- crystal clear water flow
- 2 independent single volume and temperature mixing valves
- handshower with 5' double-helix hidden hose
- 1/2" NPT female connection

 height: 7^{3/16"}
 overall projection: 10^{5/8"}
 flow rate (tub filler): 5.5 gpm (handshower) 2.5 gpm

ABCA92098

92N04 wallmount tub filler with handshower

 Polished Chrome **\$1495**
 Brushed Nickel **\$1945**

- solid brass construction
- crystal clear water flow
- 2 independent single volume and temperature mixing valves
- handshower with 5' reinforced pvc hose
- rough-in not included, order # **CB304**

 height: 5^{1/2"}
 overall projection: 13^{3/8"}
 flow rate: (tub filler) 5.5 gpm (handshower) 2.5 gpm

ABCA92097

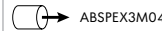

ABSPEX3M04

CB304 rough-in for wallmount tub filler 92N04

 Rough-in **\$795**

- 1/2" NPT male connection

92N85 floormount tub filler with handshower

 Polished Chrome **\$1995**
 Brushed Nickel **\$2595**

- solid brass construction
- crystal clear water flow
- 2 independent mixing valves
- handshower with 5' reinforced PVC hose
- rough-in not included, order # **92189**
- 1/2" NPT male connection

 height: 34^{1/4"}
 overall projection: 12"
 flow rate: (tub filler) 5 gpm (handshower) 2.5 gpm

ABCA92048

92189 rough-in for wallmount tub filler 92N85

 Rough-in **\$595**

- 1/2" NPT male connection





MARMO

TOSCA

OTTO

VITTORIO

REGENCY

ETNA

CUT

ALPHA

**92032 wallmount tub spout**

- solid brass construction
- crystal clear water flow
- non-diverter spout
- 1/2" NPT male connection

Polished Chrome **\$395**
Brushed Nickel **\$495**

height: 2^{5/8"}
overall projection: 8^{7/16"}
flow rate: depends on supply valve capacity

**92024 single-hole bidet with swivel spray**

- solid brass construction
- press pop up drain with overflow included
- 20° swivel aerator
- 3/8" connection

Polished Chrome **\$650**
Brushed Nickel **\$845**

height: 5^{3/16"}
overall projection: 5^{3/4"}
flow rate: 2.5 gpm



Shower Valves & Trim Set Solutions

(for complete program, see pages 241 - 292)

**SR3095 plate and handle trim set**

- 4^{1/4"}x7^{7/8"}x1/8"
- requires #12000 TURBO thermostatic valve with a choice of a shut-off valve (#1206) or a 2-3 way diverter (#61934)

Polished Chrome **\$195**
Brushed Nickel **\$255**

T12000 TURBO thermostatic valve 3/4" - 1/2"

Rough **\$455**

**SR0695 plate and handle trim set**

- 3^{1/4"}x4^{1/4"}x1/8"
- requires #1206 shut-off valve

Polished Chrome **\$160**
Brushed Nickel **\$205**

1206 1/2" shut-off valve

Rough **\$165**

SOLO

DRAINS

MIDTOWN

MUST

BLADE

LOVEME

ALPHA

METRO

CHICANE

B-JOU

MADISON

XSQUARE

STREEM



2-way

93922 plate and handle trim set with 2-way diverter
• WITH STOP – shared functions

- replaces the functionality of 2 shut-off valves
- 2^{3/4}" x 2^{3/4}" x 1/8"
- requires #61934 diverter

 Polished Chrome **\$275**
 Brushed Nickel **\$325**
61934 2 & 3 way diverter

 Rough **\$195**

2-way

93822 plate and handle trim set with 2-way diverter
• WITH STOP – 1 function at a time

- replaces the functionality of 2 shut-off valves
- 2^{3/4}" x 2^{3/4}" x 1/8"
- requires #61934 diverter

 Polished Chrome **\$275**
 Brushed Nickel **\$325**
61934 2 & 3 way diverter

 Rough **\$195**

3-way

93932 plate and handle trim set with 3-way diverter
• WITH STOP – shared functions

- replaces the functionality of 3 shut-off valves
- 2^{3/4}" x 2^{3/4}" x 1/8"
- requires #61934 diverter

 Polished Chrome **\$275**
 Brushed Nickel **\$325**
61934 2 & 3 way diverter

 Rough **\$195**

3-way

93832 plate and handle trim set with 3-way diverter
• WITH STOP – 1 function at a time

- replaces the functionality of 3 shut-off valves
- 2^{3/4}" x 2^{3/4}" x 1/8"
- requires #61934 diverter

 Polished Chrome **\$275**
 Brushed Nickel **\$325**
61934 2 & 3 way diverter

 Rough **\$195**

SR3195 plate and handle trim set

- 4^{1/4}" x 11" x 1/8"
- requires #12001 TURBO thermostatic valve

 Polished Chrome **\$340**
 Brushed Nickel **\$445**
T12001 TURBO thermostatic valve with 1 shut-off valve - 3/4" - 1/2"

 Rough **\$625**



MARMO

TOSCA

OTTO

VITTORIO

REGENCY

ETNA

CUT

ALPHA



- SR3295 plate and handle trim set**
- 4^{1/4}"x13^{3/4}"x1/8"
 - requires # 12002 TURBO thermostatic valve

Polished Chrome **\$490**
Brushed Nickel **\$640**

- T12002 TURBO thermostatic valve with 2 shut-off valve - 3/4" - 1/2"**

Rough **\$795**



- SR3395 plate and handle trim set**
- 4^{1/4}"x16^{3/4}"x1/8"
 - requires # 12003 TURBO thermostatic valve

Polished Chrome **\$645**
Brushed Nickel **\$840**

- T12003 TURBO thermostatic valve with 3 shut-off valve - 3/4" - 1/2"**

Rough **\$965**



- SR3495 plate and handle trim set**
- 4^{1/4}"x19^{5/8}"x1/8"
 - requires # 12004 TURBO thermostatic valve

Polished Chrome **\$795**
Brushed Nickel **\$1050**

- T12004 TURBO thermostatic valve with 4 shut-off valve - 3/4" - 1/2"**

Rough **\$1135**



2-way

- SR8295 plate and handle trim set with 2-way diverter**
- shared functions
 - 4^{1/4}"x12"x1/8"
 - requires #T12123 Turbo Uniplex thermostatic valve

Polished Chrome **\$455**
Brushed Nickel **\$590**

- T12123 TURBO UNIPLEX thermostatic valve 3/4" - 1/2"**

Rough **\$495**



2-way

- SR9295 plate and handle trim set with 2-way diverter**
- 1 function at a time
 - 4^{1/4}"x12"x1/8"
 - requires #T12123 Turbo Uniplex thermostatic valve

Polished Chrome **\$455**
Brushed Nickel **\$590**

- T12123 TURBO UNIPLEX thermostatic valve 3/4" - 1/2"**

Rough **\$495**



MB2

XROUND

GEO

TIME

BLOK

VOLARE

FOLIA



MIDTOWN

MUST

BLADE

LOVEME

ALPHA

METRO

CHICANE



B-JOU

MADISON

XSQUARE

STREEM

SOLO

DRAINS



3-way

- SR8395 plate and handle trim set with 3-way diverter**
- shared functions
 - 4^{1/4}"x12"x1/8"
 - requires #T12123 Turbo Uniplex thermostatic valve

Polished Chrome **\$455**
Brushed Nickel **\$590**

- T12123 TURBO UNIPLEX thermostatic valve 3/4" - 1/2"** Rough **\$495**



3-way

- SR9395 plate and handle trim set with 3-way diverter**
- 1 function at a time
 - 4^{1/4}"x12"x1/8"
 - requires #T12123 Turbo Uniplex thermostatic valve

Polished Chrome **\$455**
Brushed Nickel **\$590**

- T12123 TURBO UNIPLEX thermostatic valve 3/4" - 1/2"** Rough **\$495**



- SR4095 plate and handle trim set**
- 6^{1/2}"x8^{1/4}"x1/8"
 - requires #40255 pressure balance valve

Polished Chrome **\$165**
Brushed Nickel **\$215**

- 40255 1/2" pressure balance valve for shower**
- due to visible rough parts, select matching finish
- Polished Chrome **\$235**
Brushed Nickel **\$265**



- SR4295 plate and handle trim set**
- 6^{1/2}"x8^{1/4}"x1/8"
 - requires #42355 pressure balance valve

Polished Chrome **\$195**
Brushed Nickel **\$250**

- 42355 1/2" pressure balance valve for tub / shower**
- due to visible rough parts, select matching finish
- Polished Chrome **\$425**
Brushed Nickel **\$485**

METRO

AVAILABLE FINISHES

polished chrome



brushed nickel







MARMO

TOSCA

OTTO

VITTORIO

REGENCY

ETNA

CUT

METRO

**17014 single-hole lavatory faucet**

- solid brass construction
- aerated water flow
- press pop-up drain with overflow included
- 3/8" connection

height: 7^{5/8"}
 overall projection: 6^{1/2"}
 flow rate: 1.5 gpm



Polished Chrome **\$395**
 Brushed Nickel **\$495**



MB2

**17020 tall single-hole lavatory faucet**

- solid brass construction
- aerated water flow
- press pop-up drain with overflow included
- 3/8" connection

height: 12^{1/8"}
 overall projection: 7^{1/4"}
 flow rate: 1.5 gpm



Polished Chrome **\$615**
 Brushed Nickel **\$795**

XROUND

GEO

TIME

BLOK

VOLARE

FOLIA

**17N29 wallmount lavatory faucet**

- solid brass construction
- aerated water flow
- drain not included, see page 212 for options
- rough-in not included, order # **CB029**

height: (w/ plate) 4^{3/8"}
 overall projection: 7^{1/4"}
 flow rate: 1.5 gpm

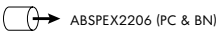

Polished Chrome **\$645**
 Brushed Nickel **\$835**

MIDTOWN

MUST

BLADE

LOVEME

ALPHA

METRO

CHICANE

CB029 rough-in for wallmount faucet # 17N29

- 1/2" NPT connection

Rough-in **\$295**



B-JOU

MADISON

XSQUARE

STREEM

SOLO

**17074 2-piece deckmount tub filler with handshower**

- solid brass construction
- aerated water flow
- handshower with 5' double-helix hidden hose
- 1/2" NPT female connection

height: 9^{1/8"}
 overall projection: 10^{5/8"}
 flow rate: (tub filler) 5.5 gpm
 (handshower) 2.5 gpm



Polished Chrome **\$695**
 Brushed Nickel **\$895**

DRAINS

17013 3-piece deckmount tub filler with handshower



- solid brass construction
- aerated water flow
- pressure balance volume control mixing valve
- handshower with 5' double-helix hidden hose
- 1/2" NPT female connection

height: 8^{5/8}"
 overall projection: 9^{5/8}"
 flow rate: (tub filler) 5 gpm (handshower) 2.5 gpm

Polished Chrome **\$655**
 Brushed Nickel **\$855**



17N85 floormount tub filler with handshower

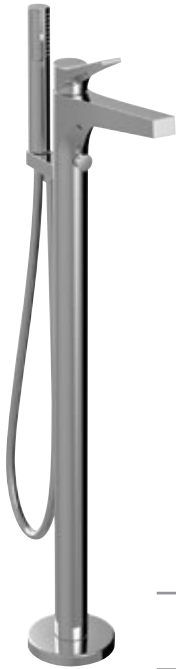

- solid brass construction
- aerated water flow
- handshower with 5' reinforced PVC hose
- 1/2" connection

height: 38^{1/4}"
 overall projection: 13^{1/2}"
 flow rate: (tub filler) 5 gpm (handshower) 2.5 gpm



Polished Chrome **\$1295**
 Brushed Nickel **\$1675**

Easy-Fit™ adaptors give extra play room and snap when faucet is pushed down

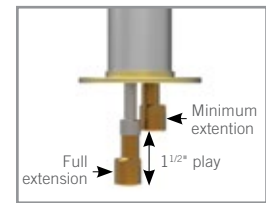

Easy-Fit™ adaptors included for an easy, fast and simple installation (see installation guide for details)



MARMO

TOSCA

OTTO

VITTORIO

REGENCY

ETNA

CUT

METRO

Shower Valves & Trim Set Solutions

(for complete program, see pages 241 - 292)

**SR3095 plate and handle trim set**

- 4^{1/4"}x7^{7/8"}x1/8"
- requires # 12000 TURBO thermostatic valve with a choice of a shut-off valve (# 1206) or a 2-3 way diverter (# 61934)

Polished Chrome **\$195**
 Brushed Nickel **\$255**

T12000 TURBO thermostatic valve 3/4" - 1/2"

Rough **\$455**

**SR0695 plate and handle trim set**

- 3^{1/4"}x4^{1/4"}x1/8"
- requires # 1206 shut-off valve

Polished Chrome **\$160**
 Brushed Nickel **\$205**

1206 TURBO 1/2" shut-off valve

Rough **\$165**



2-way

93922 plate and handle trim set with 2-way diverter

- **WITH STOP – shared functions**
- replaces the functionality of 2 shut-off valves
- 2^{3/4"}x2^{3/4"}x1/8"
- requires # 61934 diverter

Polished Chrome **\$275**
 Brushed Nickel **\$325**

61934 2 & 3 way diverter

Rough **\$195**



2-way

93822 plate and handle trim set with 2-way diverter

- **WITH STOP – 1 function at a time**
- replaces the functionality of 2 shut-off valves
- 2^{3/4"}x2^{3/4"}x1/8"
- requires # 61934 diverter

Polished Chrome **\$275**
 Brushed Nickel **\$325**

61934 2 & 3 way diverter

Rough **\$195**



MB2

XROUND

GEO

TIME

BLOK

VOLARE

FOLIA



MIDTOWN

MUST

BLADE

LOVEME

ALPHA

METRO

CHICANE



B-JOU

MADISON

XSQUARE

STREEM

SOLO

DRAINS



3-way

93932 plate and handle trim set with 3-way diverter
• WITH STOP – shared functions

- replaces the functionality of 3 shut-off valves
- 2^{3/4"} x 2^{3/4"} x 1/8"
- requires #61934 diverter

 Polished Chrome **\$275**

 Brushed Nickel **\$325**
61934 2 & 3 way diverter

 Rough **\$195**

3-way

93832 plate and handle trim set with 3-way diverter
• WITH STOP – 1 function at a time

- replaces the functionality of 3 shut-off valves
- 2^{3/4"} x 2^{3/4"} x 1/8"
- requires #61934 diverter

 Polished Chrome **\$275**

 Brushed Nickel **\$325**
61934 2 & 3 way diverter

 Rough **\$195**

SR3195 plate and handle trim set

- 4^{1/4"} x 11" x 1/8"
- requires #12001 TURBO thermostatic valve

 Polished Chrome **\$340**

 Brushed Nickel **\$445**
T12001 TURBO thermostatic valve with 1 shut-off valve - 3/4" - 1/2"

 Rough **\$625**

SR3295 plate and handle trim set

- 4^{1/4"} x 13^{3/4"} x 1/8"
- requires #12002 TURBO thermostatic valve

 Polished Chrome **\$490**

 Brushed Nickel **\$640**
T12002 TURBO thermostatic valve with 2 shut-off valve - 3/4" - 1/2"

 Rough **\$795**

SR3395 plate and handle trim set

- 4^{1/4"} x 16^{3/4"} x 1/8"
- requires #12003 TURBO thermostatic valve

 Polished Chrome **\$645**

 Brushed Nickel **\$840**
T12003 TURBO thermostatic valve with 3 shut-off valve - 3/4" - 1/2"

 Rough **\$965**



MARMO

TOSCA

OTTO

VITTORIO

REGENCY

ETNA

CUT



MB2

XROUND

GEO

TIME

BLOK

VOLARE

FOLIA



MIDTOWN

MUST

BLADE

LOVEME

ALPHA

METRO

CHICANE



B-JOU

MADISON

XSQUARE

STREEM

SOLO

DRAINS

METRO

SR3495 plate and handle trim set

- 4^{1/4"}x19^{5/8"}x1/8"
- requires #12004 TURBO thermostatic valve

Polished Chrome **\$795**
Brushed Nickel **\$1050**

T12004 TURBO thermostatic valve with 4 shut-off valve - 3/4" - 1/2"

Rough **\$1135**



2-way

SR8295 plate and handle trim set with 2-way diverter

- shared functions
- 4^{1/4"}x12"x1/8"
- requires #T12123 Turbo Uniplex thermostatic valve

Polished Chrome **\$455**
Brushed Nickel **\$590**

T12123 TURBO UNIPLEX thermostatic valve 3/4" - 1/2"

Rough **\$495**



2-way

SR9295 plate and handle trim set with 2-way diverter

- 1 function at a time
- 4^{1/4"}x12"x1/8"
- requires #T12123 Turbo Uniplex thermostatic valve

Polished Chrome **\$455**
Brushed Nickel **\$590**

T12123 TURBO UNIPLEX thermostatic valve 3/4" - 1/2"

Rough **\$495**



3-way

SR8395 plate and handle trim set with 3-way diverter

- shared functions
- 4^{1/4"}x12"x1/8"
- requires #T12123 Turbo Uniplex thermostatic valve

Polished Chrome **\$455**
Brushed Nickel **\$590**

T12123 TURBO UNIPLEX thermostatic valve 3/4" - 1/2"

Rough **\$495**



3-way

SR9395 plate and handle trim set with 3-way diverter

- 1 function at a time
- 4^{1/4"}x12"x1/8"
- requires #T12123 Turbo Uniplex thermostatic valve

Polished Chrome **\$455**
Brushed Nickel **\$590**

T12123 TURBO UNIPLEX thermostatic valve 3/4" - 1/2"

Rough **\$495**

SR4095 plate and handle trim set

- 6^{1/2}"x8^{1/4}"x1/8"
- requires #40255 pressure balance valve

Polished Chrome **\$165**
Brushed Nickel **\$215**



40255 1/2" pressure balance valve for shower

- due to visible rough parts, select matching finish

Polished Chrome **\$235**
Brushed Nickel **\$265**

SR4295 plate and handle trim set

- 6^{1/2}"x8^{1/4}"x1/8"
- requires #42355 pressure balance valve

Polished Chrome **\$195**
Brushed Nickel **\$250**



42355 1/2" pressure balance valve for tub / shower

- due to visible rough parts, select matching finish

Polished Chrome **\$425**
Brushed Nickel **\$485**

CHICANE

AVAILABLE FINISHES

polished chrome



brushed nickel







MARMO

TOSCA

OTTO

VITTORIO

REGENCY

ETNA

CUT



MB2

XROUND

GEO

TIME

BLOK

VOLARE

FOLIA



MIDTOWN

MUST

BLADE

LOVEME

ALPHA

METRO

CHICANE



B-JOU

MADISON

XSQUARE

STREEM

SOLO

DRAINS

CHICANE



19014 single-hole lavatory faucet

- solid brass construction
- recessed aerator – aerated water flow
- press pop-up drain with overflow included
- 3/8" connection

height: 6^{1/8}"
overall projection: 6^{3/8}"
flow rate: 1.5 gpm



Polished Chrome **\$545**
Brushed Nickel **\$695**



19020 tall single-hole lavatory faucet

- solid brass construction
- recessed aerator – aerated water flow
- press pop-up drain with overflow included
- 3/8" connection

height: 11^{1/8}"
overall projection: 7^{3/4}"
flow rate: 1.5 gpm



Polished Chrome **\$875**
Brushed Nickel **\$1150**



19N29 wallmount lavatory faucet

- solid brass construction
- recessed aerator – aerated water flow
- drain not included, see page 212 for options
- rough-in not included, order # **CB029**

height: (w/ plate) 4^{3/8}"
overall projection: 7^{3/4}"
flow rate: 1.5 gpm

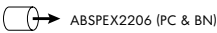

Polished Chrome **\$745**
Brushed Nickel **\$965**



CB029 rough-in for wallmount faucet # 19N29

- 1/2" NPT connection

Rough-in **\$295**



19074 2-piece deckmount tub filler with handshower

- solid brass construction
- aerated water flow
- handshower with 5' double-helix hidden hose
- 1/2" connection

height: (w/ handshower) 9^{1/8}"
overall projection: 9"
flow rate: (tub filler) 7 gpm
(handshower) 2.5 gpm



Polished Chrome **\$1495**
Brushed Nickel **\$1950**

CHICANE

19032 wallmount tub spout



- solid brass construction
- aerated water flow
- non-diverter spout
- 1/2" connection

overall projection: 9^{3/4}"

flow rate: depends on supply valve capacity

Polished Chrome **\$495**

Brushed Nickel **\$650**

19085 floormount tub filler with handshower



- solid brass construction
- aerated water flow
- handshower with 5' reinforced PVC hose
- 1/2" connection

height: 34"

overall projection: 9^{1/6}"

flow rate: (tub filler) 6.5 gpm
(handshower) 2.5 gpm



ABCA19098

Polished Chrome **\$2795**

Brushed Nickel **\$3595**

--- Easy-Fit™ adaptors included for an easy, fast and simple installation (see installation guide for details)

Easy-Fit™ adaptors give extra play room and snap when faucet is pushed down

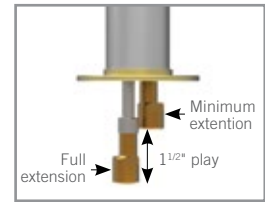

MARMO

TOSCA

OTTO

VITTORIO

REGENCY

ETNA

CUT



MB2

XROUND

GEO

TIME

BLOK

VOLARE

FOLIA



MIDTOWN

MUST

BLADE

LOVEME

ALPHA

METRO

CHICANE



B-JOU

MADISON

XSQUARE

STREEM

SOLO

DRAINS



MARMO

TOSCA

OTTO

VITTORIO

REGENCY

ETNA

CUT

CHICANE

Shower Valves & Trim Set Solutions

(for complete program, see pages 241 - 292)

**S3076 plate and handle trim set**

- 4^{1/4}" x 7^{7/8}" x 1/8"
- requires # 12000 TURBO thermostatic valve with a choice of a shut-off valve (# 1206) or a 2-3 way diverter (# 61934)

Polished Chrome **\$290**
 Brushed Nickel **\$380**

T12000 TURBO thermostatic valve 3/4" - 1/2"

Rough **\$455**

**S0695 plate and handle trim set**

- 3^{1/4}" x 4^{1/4}" x 1/8"
- requires # 1206 shut-off valve

Polished Chrome **\$160**
 Brushed Nickel **\$205**

1206 1/2" shut-off valve

Rough **\$165**



2-way

93923 plate and handle trim set with 2-way diverter

- **WITH STOP – shared functions**
- replaces the functionality of 2 shut-off valves
- 2^{3/4}" x 2^{3/4}" x 1/8"
- requires # 61934 diverter

Polished Chrome **\$275**
 Brushed Nickel **\$325**

61934 2 & 3 way diverter

Rough **\$195**



2-way

93823 plate and handle trim set with 2-way diverter

- **WITH STOP – 1 function at a time**
- replaces the functionality of 2 shut-off valves
- 2^{3/4}" x 2^{3/4}" x 1/8"
- requires # 61934 diverter

Polished Chrome **\$275**
 Brushed Nickel **\$325**

61934 2 & 3 way diverter

Rough **\$195**



MB2

XROUND

GEO

TIME

BLOK

VOLARE

FOLIA



MIDTOWN

MUST

BLADE

LOVEME

ALPHA

METRO

CHICANE



B-JOU

MADISON

XSQUARE

STREEM

SOLO

DRAINS



3-way

93933 plate and handle trim set with 3-way diverter

• WITH STOP – shared functions

- replaces the functionality of 3 shut-off valves
- 2^{3/4}" x 2^{3/4}" x 1/8"
- requires #61934 diverter

Polished Chrome **\$275**

Brushed Nickel **\$325**

61934 2 & 3 way diverter

Rough **\$195**



3-way

93833 plate and handle trim set with 3-way diverter

• WITH STOP – 1 function at a time

- replaces the functionality of 3 shut-off valves
- 2^{3/4}" x 2^{3/4}" x 1/8"
- requires #61934 diverter

Polished Chrome **\$275**

Brushed Nickel **\$325**

61934 2 & 3 way diverter

Rough **\$195**



S3176 plate and handle trim set

- 4^{1/4}" x 11" x 1/8"
- requires #12001 TURBO thermostatic valve

Polished Chrome **\$435**

Brushed Nickel **\$570**

T12001 TURBO thermostatic valve with 1 shut-off valve - 3/4" - 1/2"

Rough **\$625**



S3276 plate and handle trim set

- 4^{1/4}" x 13^{3/4}" x 1/8"
- requires #12002 TURBO thermostatic valve

Polished Chrome **\$585**

Brushed Nickel **\$765**

T12002 TURBO thermostatic valve with 2 shut-off valve - 3/4" - 1/2"

Rough **\$795**



S3376 plate and handle trim set

- 4^{1/4}" x 16^{3/4}" x 1/8"
- requires #12003 TURBO thermostatic valve

Polished Chrome **\$740**

Brushed Nickel **\$965**

T12003 TURBO thermostatic valve with 3 shut-off valve - 3/4" - 1/2"

Rough **\$965**



MARMO

TOSCA

OTTO

VITTORIO

REGENCY

ETNA

CUT



MB2

XROUND

GEO

TIME

BLOK

VOLARE

FOLIA



MIDTOWN

MUST

BLADE

LOVEME

ALPHA

METRO

CHICANE



B-JOU

MADISON

XSQUARE

STREEM

SOLO

DRAINS

CHICANE



S3476 plate and handle trim set

- 4^{1/4}"x19^{5/8}"x1/8"
- requires #12004 TURBO thermostatic valve

Polished Chrome **\$890**
Brushed Nickel **\$1175**

T12004 TURBO thermostatic valve with 4 shut-off valve - 3/4" - 1/2"

Rough **\$1135**



S8276 plate and handle trim set with 2-way diverter

- shared functions
- 4^{1/4}"x12"x1/8"
- requires #T12123 Turbo Uniplex thermostatic valve

Polished Chrome **\$550**
Brushed Nickel **\$715**

T12123 TURBO UNIPLEX thermostatic valve 3/4" - 1/2"

Rough **\$495**

2-way



S9276 plate and handle trim set with 2-way diverter

- 1 function at a time
- 4^{1/4}"x12"x1/8"
- requires #T12123 Turbo Uniplex thermostatic valve

Polished Chrome **\$550**
Brushed Nickel **\$715**

T12123 TURBO UNIPLEX thermostatic valve 3/4" - 1/2"

Rough **\$495**

2-way



S8376 plate and handle trim set with 3-way diverter

- shared functions
- 4^{1/4}"x12"x1/8"
- requires #T12123 Turbo Uniplex thermostatic valve

Polished Chrome **\$550**
Brushed Nickel **\$715**

T12123 TURBO UNIPLEX thermostatic valve 3/4" - 1/2"

Rough **\$495**

3-way



S9376 plate and handle trim set with 3-way diverter

- 1 function at a time
- 4^{1/4}"x12"x1/8"
- requires #T12123 Turbo Uniplex thermostatic valve

Polished Chrome **\$550**
Brushed Nickel **\$715**

T12123 TURBO UNIPLEX thermostatic valve 3/4" - 1/2"

Rough **\$495**

3-way

CHICANE



S4095 plate and handle trim set

- 6^{1/2}"x8^{1/4}"x1/8"
- requires #40255 pressure balance valve

Polished Chrome **\$165**
Brushed Nickel **\$215**

40255 1/2" pressure balance valve for shower

- due to visible rough parts, select matching finish

Polished Chrome **\$235**
Brushed Nickel **\$265**



S4295 plate and handle trim set

- 6^{1/2}"x8^{1/4}"x1/8"
- requires #42355 pressure balance valve

Polished Chrome **\$195**
Brushed Nickel **\$250**

42355 1/2" pressure balance valve for tub / shower

- due to visible rough parts, select matching finish

Polished Chrome **\$425**
Brushed Nickel **\$485**



MARMO

TOSCA

OTTO

VITTORIO

REGENCY

ETNA

CUT



MB2

XROUND

GEO

TIME

BLOK

VOLARE

FOLIA



MIDTOWN

MUST

BLADE

LOVEME

ALPHA

METRO

CHICANE



B-JOU

MADISON

XSQUARE

STREEM

SOLO

DRAINS

B-JOU

AVAILABLE FINISHES

polished chrome



brushed nickel



CHOICE OF HANDLES



B-JOU
metal



B-JOU STAR
Swarovski crystal

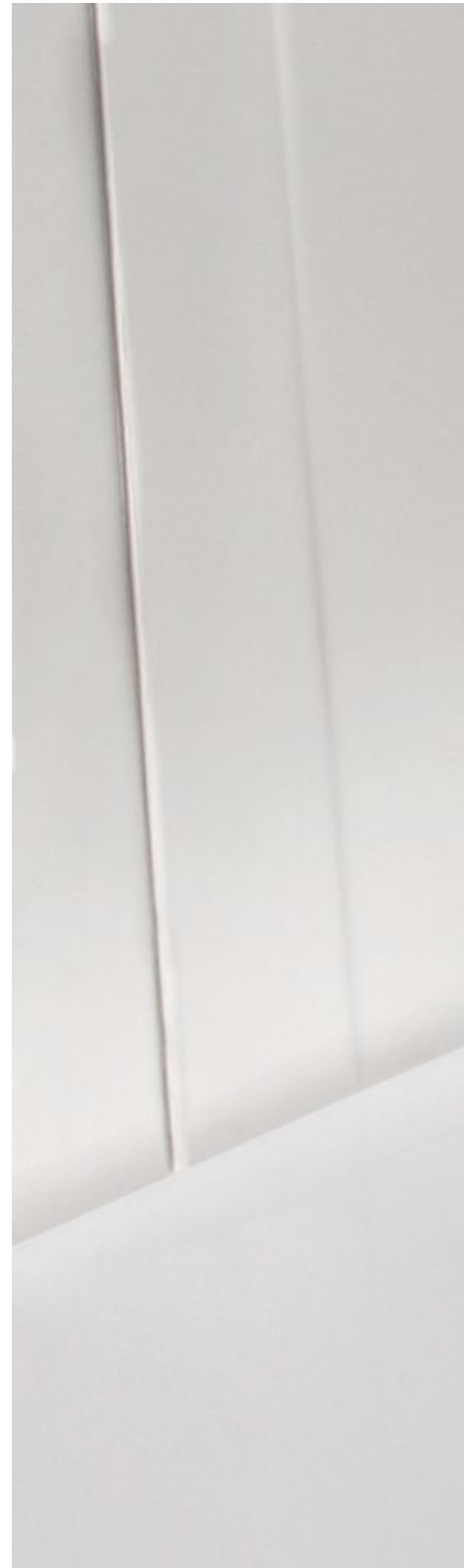





MARMO

TOSCA

OTTO

VITTORIO

REGENCY

ETNA

CUT

B-JOU



84514 single-hole lavatory faucet

- solid brass construction
- crystal clear water flow
- press pop-up drain with overflow included
- 3/8" connection

height: 5^{3/16"}
 overall projection: 7^{1/16"}
 flow rate: 1.75 gpm



ABCA84998

Polished Chrome **\$395**
 Brushed Nickel **\$495**



MB2

XROUND

GEO

TIME

BLOK

VOLARE

FOLIA



84520 tall single-hole lavatory faucet

- solid brass construction
- crystal clear water flow
- press pop-up drain with overflow included
- 3/8" connection

height: 11^{1/16"}
 overall projection: 7^{1/16"}
 flow rate: 1.75 gpm



ABCA84998

Polished Chrome **\$495**
 Brushed Nickel **\$645**



MIDTOWN

MUST

BLADE

LOVEME

ALPHA

METRO

CHICANE



84516 widespread lavatory faucet

- solid brass construction
- crystal clear water flow
- press pop-up drain with overflow included
- 1/2" connection

height: 3^{7/8"}
 overall projection: 7^{1/16"}
 flow rate: 1.75 gpm

ABCA84898 / HOT
ABCA84899 / COLD

Polished Chrome **\$595**
 Brushed Nickel **\$775**



B-JOU

MADISON

XSQUARE

STREEM

SOLO



84518 4-piece deckmount tub filler with handshower

- solid brass construction
- crystal clear water flow
- handshower with 5' double-helix hidden hose
- 1/2" connection

height: 8^{1/4"}
 overall projection: 8^{7/8"}
 flow rate: (tub filler) 9 gpm
 (handshower) 2.5 gpm

ABCA84898 / HOT
ABCA84899 / COLD

Polished Chrome **\$845**
 Brushed Nickel **\$1095**

84584 floormount tub filler with handshower



- solid brass construction
- crystal clear water flow
- handshower with 5" reinforced PVC hose
- pull-button diverter on the side of the spout
- 1/2" connection

height: 34^{1/4"}

overall projection: 10^{1/4"}

flow rate (tub filler): 4.5 gpm
(handshower) 2.5 gpm



ABCA86499

Polished Chrome **\$1395**

Brushed Nickel **\$1795**

Easy-Fit™ adaptors included for an easy, fast and simple installation (see installation guide for details)

Easy-Fit™ adaptors give extra play room and snap when faucet is pushed down

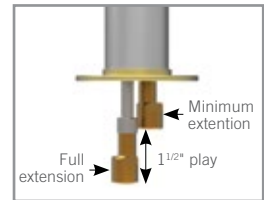

84526 4 hole bidet set



- solid brass construction
- incorporated vacuum breaker and vertical spray
- mechanical drain included
- 1/2" connection

height: 4^{11/16"}

flow rate: full flow



ABCA84898 / HOT
ABCA84899 / COLD

Polished Chrome **\$1350**

Brushed Nickel **\$1750**



MARMO

TOSCA

OTTO

VITTORIO

REGENCY

ETNA

CUT

B-JOU STAR

84014 single-hole lavatory faucet WITH CRYSTAL



- solid brass construction
- crystal clear water flow
- lever with Swarovski crystal insert
- press pop-up drain with overflow included
- 3/8" connection

height: 5^{3/16"}overall projection: 7^{1/16"}

flow rate: 1.75 gpm



ABCA84998

Polished Chrome **\$530**Brushed Nickel **\$685**

MB2

XROUND

GEO

TIME

BLOK

VOLARE

FOLIA



84020 tall single-hole lavatory faucet WITH CRYSTAL

- solid brass construction
- crystal clear water flow
- lever with Swarovski crystal insert
- press pop-up drain with overflow included
- 3/8" connection

height: 11^{1/16"}overall projection: 7^{1/16"}

flow rate: 1.75 gpm



ABCA84998

Polished Chrome **\$630**Brushed Nickel **\$825**

MIDTOWN

MUST

BLADE

LOVEME

ALPHA

METRO

CHICANE

84016 widespread lavatory faucet WITH CRYSTAL



- solid brass construction
- crystal clear water flow
- handles with Swarovski crystal insert
- press pop-up drain with overflow included
- 1/2" connection

height: 3^{7/8"}overall projection: 7^{1/16"}

flow rate: 1.75 gpm

ABCA84898 / HOT
ABCA84899 / COLDPolished Chrome **\$865**Brushed Nickel **\$1125**

B-JOU

MADISON

XSQUARE

STREAM

SOLO

84018 4-piece deckmount tub filler w/ handshower and CRYSTAL

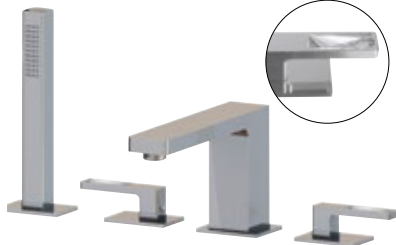

- solid brass construction
- crystal clear water flow
- handles with Swarovski crystal insert
- handshower with 5' double-helix hidden hose
- 1/2" connection

height: 8^{1/4"}overall projection: 8^{7/8"}

flow rate (tub filler): 9 gpm

(handshower) 2.5 gpm

ABCA84898 / HOT
ABCA84899 / COLDPolished Chrome **\$1115**Brushed Nickel **\$1445**

B-JOU STAR

- ∞
- MARMO
- TOSCA
- OTTO
- VITTORIO
- REGENCY
- ETNA
- CUT

-
- MB2
- XROUND
- GEO
- TIME
- BLOK
- VOLARE
- FOLIA

- ◻
- MIDTOWN
- MUST
- BLADE
- LOVEME
- ALPHA
- METRO
- CHICANE

- ◻
- B-JOU
- MADISON
- X SQUARE
- STREAM

- SOLO

- DRAINS

84084 floormount tub filler w/ handshower and CRYSTAL

Polished Chrome **\$1530**
Brushed Nickel **\$1985**



- solid brass construction
- crystal clear water flow
- lever with Swarovski crystal insert
- handshower with 5" reinforced PVC hose
- pull-button diverter on the side of the spout
- 1/2" connection

height: 34^{1/4"}

overall projection: 10^{1/4"}

flow rate (tub filler): 4.5 gpm
(handshower) 2.5 gpm



Easy-Fit™ adaptors included for an easy, fast and simple installation (see installation guide for details)

Easy-Fit™ adaptors give extra play room and snap when faucet is pushed down

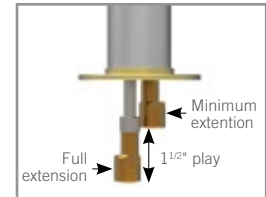

84026 4 hole bidet set WITH CRYSTAL

Polished Chrome **\$1620**
Brushed Nickel **\$2095**



- solid brass construction
- lever with Swarovski crystal insert
- incorporated vacuum breaker and vertical spray
- mechanical drain included
- 1/2" connection

height: 4^{11/16"}

flow rate: full flow

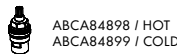



MARMO

TOSCA

OTTO

VITTORIO

REGENCY

ETNA

CUT

B-JOU

Shower Valves & Trim Set Solutions

(for complete program, see pages 241 - 292)

**S3084 plate and handle trim set**

- 4^{1/4}" x 7^{7/8}" x 1/8"
- requires # 12000 TURBO thermostatic valve with a choice of a shut-off valve (# 1206) or a 2-3 way diverter (# 61934)

Polished Chrome **\$290**
 Brushed Nickel **\$380**

T12000 TURBO thermostatic valve 3/4" - 1/2"

Rough **\$455**

**S0695 plate and handle trim set**

- 3^{1/4}" x 4^{1/4}" x 1/8"
- requires # 1206 shut-off valve

Polished Chrome **\$160**
 Brushed Nickel **\$205**

1206 1/2" shut-off valve

Rough **\$165**



2-way

93923 plate and handle trim set with 2-way diverter

- **WITH STOP – shared functions**
- replaces the functionality of 2 shut-off valves
- 2^{3/4}" x 2^{3/4}" x 1/8"
- requires # 61934 diverter

Polished Chrome **\$275**
 Brushed Nickel **\$325**

61934 2 & 3 way diverter

Rough **\$195**



2-way

93823 plate and handle trim set with 2-way diverter

- **WITH STOP – 1 function at a time**
- replaces the functionality of 2 shut-off valves
- 2^{3/4}" x 2^{3/4}" x 1/8"
- requires # 61934 diverter

Polished Chrome **\$275**
 Brushed Nickel **\$325**

61934 2 & 3 way diverter

Rough **\$195**



MB2

XROUND

GEO

TIME

BLOK

VOLARE

FOLIA



MIDTOWN

MUST

BLADE

LOVEME

ALPHA

METRO

CHICANE



B-JOU

MADISON

XSQUARE

STREEM

SOLO

DRAINS



3-way

93933 plate and handle trim set with 3-way diverter
• WITH STOP – shared functions

- replaces the functionality of 3 shut-off valves
- 2^{3/4}" x 2^{3/4}" x 1/8"
- requires #61934 diverter

 Polished Chrome **\$275**

 Brushed Nickel **\$325**
61934 2 & 3 way diverter

 Rough **\$195**

3-way

93833 plate and handle trim set with 3-way diverter
• WITH STOP – 1 function at a time

- replaces the functionality of 3 shut-off valves
- 2^{3/4}" x 2^{3/4}" x 1/8"
- requires #61934 diverter

 Polished Chrome **\$275**

 Brushed Nickel **\$325**
61934 2 & 3 way diverter

 Rough **\$195**

S3184 plate and handle trim set

- 4^{1/4}" x 11" x 1/8"
- requires #12001 TURBO thermostatic valve

 Polished Chrome **\$435**

 Brushed Nickel **\$570**
T12001 TURBO thermostatic valve with 1 shut-off valve - 3/4" - 1/2"

 Rough **\$625**

S3284 plate and handle trim set

- 4^{1/4}" x 13^{3/4}" x 1/8"
- requires #12002 TURBO thermostatic valve

 Polished Chrome **\$585**

 Brushed Nickel **\$765**
T12002 TURBO thermostatic valve with 2 shut-off valve - 3/4" - 1/2"

 Rough **\$795**

S3384 plate and handle trim set

- 4^{1/4}" x 16^{3/4}" x 1/8"
- requires #12003 TURBO thermostatic valve

 Polished Chrome **\$740**

 Brushed Nickel **\$965**
T12003 TURBO thermostatic valve with 3 shut-off valve - 3/4" - 1/2"

 Rough **\$965**



MARMO

TOSCA

OTTO

VITTORIO

REGENCY

ETNA

CUT



MB2

XROUND

GEO

TIME

BLOK

VOLARE

FOLIA



MIDTOWN

MUST

BLADE

LOVEME

ALPHA

METRO

CHICANE



B-JOU

MADISON

XSQUARE

STREEM

SOLO

DRAINS

B-JOU

**S3484 plate and handle trim set**

- 4^{1/4}"x19^{5/8}"x1/8"
- requires #12004 TURBO thermostatic valve

Polished Chrome **\$890**
Brushed Nickel **\$1175**

T12004 TURBO thermostatic valve with 4 shut-off valve - 3/4" - 1/2"

Rough **\$1135**



2-way

S8284 plate and handle trim set with 2-way diverter

- shared functions
- 4^{1/4}"x12"x1/8"
- requires #T12123 Turbo Uniplex thermostatic valve

Polished Chrome **\$550**
Brushed Nickel **\$715**

T12123 TURBO UNIPLEX thermostatic valve 3/4" - 1/2"

Rough **\$495**



2-way

S9284 plate and handle trim set with 2-way diverter

- 1 function at a time
- 4^{1/4}"x12"x1/8"
- requires #T12123 Turbo Uniplex thermostatic valve

Polished Chrome **\$550**
Brushed Nickel **\$715**

T12123 TURBO UNIPLEX thermostatic valve 3/4" - 1/2"

Rough **\$495**



3-way

S8384 plate and handle trim set with 3-way diverter

- shared functions
- 4^{1/4}"x12"x1/8"
- requires #T12123 Turbo Uniplex thermostatic valve

Polished Chrome **\$550**
Brushed Nickel **\$715**

T12123 TURBO UNIPLEX thermostatic valve 3/4" - 1/2"

Rough **\$495**



3-way

S9384 plate and handle trim set with 3-way diverter

- 1 function at a time
- 4^{1/4}"x12"x1/8"
- requires #T12123 Turbo Uniplex thermostatic valve

Polished Chrome **\$550**
Brushed Nickel **\$715**

T12123 TURBO UNIPLEX thermostatic valve 3/4" - 1/2"

Rough **\$495**

B-JOU



S4095 plate and handle trim set

- 6^{1/2}"x8^{1/4}"x1/8"
- requires #40255 pressure balance valve

Polished Chrome **\$165**
Brushed Nickel **\$215**

40255 1/2" pressure balance valve for shower

- due to visible rough parts, select matching finish

Polished Chrome **\$235**
Brushed Nickel **\$265**



S4295 plate and handle trim set

- 6^{1/2}"x8^{1/4}"x1/8"
- requires #42355 pressure balance valve

Polished Chrome **\$195**
Brushed Nickel **\$250**

42355 1/2" pressure balance valve for tub / shower

- due to visible rough parts, select matching finish

Polished Chrome **\$425**
Brushed Nickel **\$485**

- ∞
- MARMO
- TOSCA
- OTTO
- VITTORIO
- REGENCY
- ETNA
- CUT

-
- MB2
- XROUND
- GEO
- TIME
- BLOK
- VOLARE
- FOLIA

- ◻
- MIDTOWN
- MUST
- BLADE
- LOVEME
- ALPHA
- METRO
- CHICANE

- ◻
- B-JOU**
- MADISON
- XSQUARE
- STREEM

- SOLO

- DRAINS

MADISON

AVAILABLE FINISHES

polished chrome



brushed nickel







MARMO

TOSCA

OTTO

VITTORIO

REGENCY

ETNA

CUT

MADISON



86014 single-hole lavatory faucet

- solid brass construction
- aerated water flow
- press pop-up drain with overflow included
- 3/8" connection

height: 5^{1/2}"
 overall projection: 5^{5/8}"
 flow rate: 1.5 gpm



ABCA86094

Polished Chrome **\$295**
 Brushed Nickel **\$385**



86020 tall single-hole lavatory faucet

- solid brass construction
- aerated water flow
- press pop-up drain with overflow included
- 3/8" connection

height: 10^{5/8}"
 overall projection: 5^{5/8}"
 flow rate: 1.5 gpm



ABCA86094

Polished Chrome **\$445**
 Brushed Nickel **\$575**



86013 3-piece deckmount tub filler with handshower

- solid brass construction
- aerated water flow
- pressure balance volume control mixing valve
- handshower with 5' double-helix hidden hose
- 1/2" connection

height: 7^{3/4}"
 overall projection: 8^{1/16}"
 flow rate: (tub filler) 5 gpm (handshower) 2.5 gpm



ABCA86193

Polished Chrome **\$655**
 Brushed Nickel **\$855**



86N85 floormount tub filler with handshower

- solid brass construction
- aerated water flow
- handshower with 5' reinforced PVC hose
- 1/2" connection

height: 34^{1/4}"
 overall projection: 10^{1/4}"
 flow rate: (tub filler) 4.5 gpm
 (handshower) 2.5 gpm



ABCA86499

Polished Chrome **\$1195**
 Brushed Nickel **\$1550**

Easy-Fit™ adaptors included for an easy, fast and simple installation (see installation guide for details)

Easy-Fit™ adaptors give extra play room and snap when faucet is pushed down

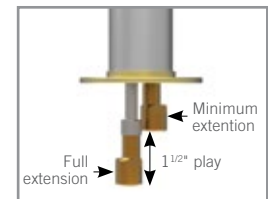

DRAINS

B-JOU

MADISON

XSQUARE

STREEM

MIDTOWN

MUST

BLADE

LOVEME

ALPHA

METRO

CHICANE



Shower Valves & Trim Set Solutions

(for complete program, see pages 241 - 292)



S3095 plate and handle trim set

- 4^{1/4}"x7^{7/8}"x1/8"
- requires # 12000 TURBO thermostatic valve with a choice of a shut-off valve (#1206) or a 2-3 way diverter (#61934)

Polished Chrome **\$195**
Brushed Nickel **\$255**

T12000 TURBO thermostatic valve 3/4" - 1/2"

Rough **\$455**



S0695 plate and handle trim set

- 3^{1/4}"x4^{1/4}"x1/8"
- requires # 1206 shut-off valve

Polished Chrome **\$160**
Brushed Nickel **\$205**

1206 1/2" shut-off valve

Rough **\$165**



2-way

93923 plate and handle trim set with 2-way diverter

- **WITH STOP – shared functions**
- replaces the functionality of 2 shut-off valves
- 2^{3/4}" x 2^{3/4}" x 1/8"
- requires #61934 diverter

Polished Chrome **\$275**
Brushed Nickel **\$325**

61934 2 & 3 way diverter

Rough **\$195**



2-way

93823 plate and handle trim set with 2-way diverter

- **WITH STOP – 1 function at a time**
- replaces the functionality of 2 shut-off valves
- 2^{3/4}" x 2^{3/4}" x 1/8"
- requires #61934 diverter

Polished Chrome **\$275**
Brushed Nickel **\$325**

61934 2 & 3 way diverter

Rough **\$195**



MARMO

TOSCA

OTTO

VITTORIO

REGENCY

ETNA

CUT

MADISON



3-way

93933 plate and handle trim set with 3-way diverter**• WITH STOP – shared functions**

- replaces the functionality of 3 shut-off valves
- 2^{3/4}" x 2^{3/4}" x 1/8"
- requires # 61934 diverter

Polished Chrome

\$275

Brushed Nickel

\$325**61934 2 & 3 way diverter**

Rough

\$195

3-way

93833 plate and handle trim set with 3-way diverter**• WITH STOP – 1 function at a time**

- replaces the functionality of 3 shut-off valves
- 2^{3/4}" x 2^{3/4}" x 1/8"
- requires # 61934 diverter

Polished Chrome

\$275

Brushed Nickel

\$325**61934 2 & 3 way diverter**

Rough

\$195**S3195 plate and handle trim set**

- 4^{1/4}" x 11" x 1/8"
- requires # 12001 TURBO thermostatic valve

Polished Chrome

\$340

Brushed Nickel

\$445**T12001 TURBO thermostatic valve with 1 shut-off valve - 3/4" - 1/2"**

Rough

\$625**S3295 plate and handle trim set**

- 4^{1/4}" x 13^{3/4}" x 1/8"
- requires # 12002 TURBO thermostatic valve

Polished Chrome

\$490

Brushed Nickel

\$640**T12002 TURBO thermostatic valve with 2 shut-off valve - 3/4" - 1/2"**

Rough

\$795**S3395 plate and handle trim set**

- 4^{1/4}" x 16^{3/4}" x 1/8"
- requires # 12003 TURBO thermostatic valve

Polished Chrome

\$645

Brushed Nickel

\$840**T12003 TURBO thermostatic valve with 3 shut-off valve - 3/4" - 1/2"**

Rough

\$965

MB2

XROUND

GEO

TIME

BLOK

VOLARE

FOLIA



MIDTOWN

MUST

BLADE

LOVEME

ALPHA

METRO

CHICANE



B-JOU

MADISON

XSQUARE

STREEM

SOLO

DRAINS

S3495 plate and handle trim set

- 4^{1/4}"x19^{5/8}"x1/8"
- requires #12004 TURBO thermostatic valve

Polished Chrome

\$795

Brushed Nickel

\$1050
T12004 TURBO thermostatic valve with 4 shut-off valve - 3/4" - 1/2"

Rough

\$1135

2-way

S8295 plate and handle trim set with 2-way diverter

- shared functions
- 4^{1/4}"x12"x1/8"
- requires #T12123 Turbo Uniplex thermostatic valve

Polished Chrome

\$455

Brushed Nickel

\$590
T12123 TURBO UNIPLEX thermostatic valve 3/4" - 1/2"

Rough

\$495

2-way

S9295 plate and handle trim set with 2-way diverter

- 1 function at a time
- 4^{1/4}"x12"x1/8"
- requires #T12123 Turbo Uniplex thermostatic valve

Polished Chrome

\$455

Brushed Nickel

\$590
T12123 TURBO UNIPLEX thermostatic valve 3/4" - 1/2"

Rough

\$495

3-way

S8395 plate and handle trim set with 3-way diverter

- shared functions
- 4^{1/4}"x12"x1/8"
- requires #T12123 Turbo Uniplex thermostatic valve

Polished Chrome

\$455

Brushed Nickel

\$590
T12123 TURBO UNIPLEX thermostatic valve 3/4" - 1/2"

Rough

\$495

3-way

S9395 plate and handle trim set with 3-way diverter

- 1 function at a time
- 4^{1/4}"x12"x1/8"
- requires #T12123 Turbo Uniplex thermostatic valve

Polished Chrome

\$455

Brushed Nickel

\$590
T12123 TURBO UNIPLEX thermostatic valve 3/4" - 1/2"

Rough

\$495



MARMO

TOSCA

OTTO

VITTORIO

REGENCY

ETNA

CUT



S4095 plate and handle trim set

- 6 1/2" x 8 1/4" x 1/8"
- requires # 40255 pressure balance valve

Polished Chrome **\$165**
 Brushed Nickel **\$215**

40255 1/2" pressure balance valve for shower

- due to visible rough parts, select matching finish

Polished Chrome **\$235**
 Brushed Nickel **\$265**



MB2

XROUND

GEO

TIME

BLOK

VOLARE

FOLIA



S4295 plate and handle trim set

- 6 1/2" x 8 1/4" x 1/8"
- requires # 42355 pressure balance valve

Polished Chrome **\$195**
 Brushed Nickel **\$250**

42355 1/2" pressure balance valve for tub / shower

- due to visible rough parts, select matching finish

Polished Chrome **\$425**
 Brushed Nickel **\$485**



MIDTOWN

MUST

BLADE

LOVEME

ALPHA

METRO

CHICANE



B-JOU

MADISON

XSQUARE

STREEM

SOLO

DRAINS



MARMO

TOSCA

OTTO

VITTORIO

REGENCY

ETNA

CUT



MB2

XROUND

GEO

TIME

BLOK

VOLARE

FOLIA



MIDTOWN

MUST

BLADE

LOVEME

ALPHA

METRO

CHICANE



B-JOU

MADISON

X SQUARE

STREEM

SOLO

DRAINS

XSQUARE

AVAILABLE FINISHES

polished chrome



XSQUARE collection is also available
in Aquabrass' custom finishes
(10 weeks lead time, see finish chart p.vii)

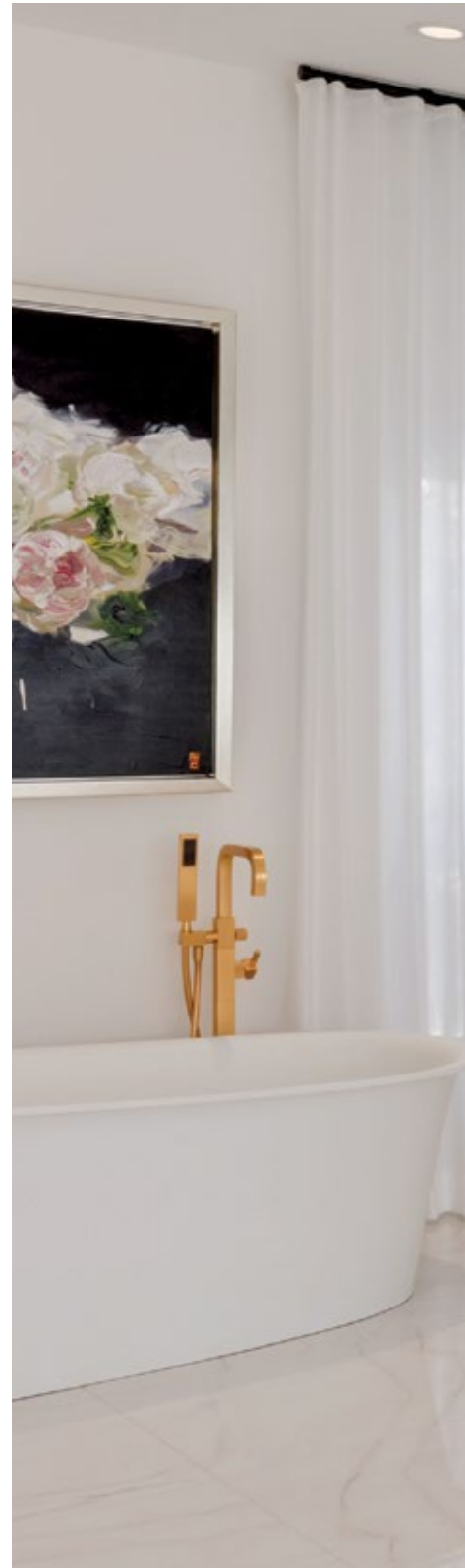





MARMO

TOSCA

OTTO

VITTORIO

REGENCY

ETNA

CUT

XSQUARE

**X7614 single-hole lavatory faucet**

- solid brass construction
- recessed aerator – aerated water flow
- press pop-up drain with overflow included
- 3/8" connection

height: 12^{3/8"}
 overall projection: 6^{3/8"}
 flow rate: 2.2 gpm



Polished Chrome **\$995**
 Custom Finish **\$1990**

**X7612 2-piece lavatory faucet with side joystick**

- solid brass construction
- recessed aerator – aerated water flow
- single volume and temperature joystick control
- press pop-up drain with overflow included
- 3/8" connection

height: 11"
 overall projection: 6^{5/8"}
 flow rate: 2.2 gpm



Polished Chrome **\$995**
 Custom Finish **\$1990**

**X7702 2-piece lavatory faucet with side joystick**

- solid brass construction
- recessed aerator – aerated water flow
- single volume and temperature joystick control
- press pop-up drain with overflow included
- 3/8" connection

height: 8"
 overall projection: 5"
 flow rate: 2.2 gpm



Polished Chrome **\$995**
 Custom Finish **\$1990**

**X7710 short widespread lavatory faucet**

- solid brass construction
- recessed aerator – aerated water flow
- press pop-up drain with overflow included
- 1/2" connection

height: 8"
 overall projection: 5"
 flow rate: 2.2 gpm

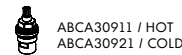

Polished Chrome **\$1195**
 Custom Finish **\$2390**

**X7910 short widespread lavatory faucet**

- solid brass construction
- recessed aerator – aerated water flow
- press pop-up drain with overflow included
- 1/2" connection

height: 8"
 overall projection: 5"
 flow rate: 2.2 gpm

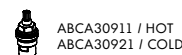

Polished Chrome **\$1195**
 Custom Finish **\$2390**



MB2

XROUND

GEO

TIME

BLOK

VOLARE

FOLIA



MIDTOWN

MUST

BLADE

LOVEME

ALPHA

METRO

CHICANE



B-JOU

MADISON

XSQUARE

STREEM

SOLO



X7616 widespread lavatory faucet

- solid brass construction
- recessed aerator – aerated water flow
- press pop-up drain with overflow included
- 1/2" connection

height: 11"
 overall projection: 6^{5/8}"
 flow rate: 2.2 gpm

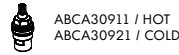

Polished Chrome **\$1195**

Custom Finish **\$2390**



X7816 widespread lavatory faucet

- solid brass construction
- recessed aerator – aerated water flow
- press pop-up drain with overflow included
- 1/2" connection

height: 11"
 overall projection: 6^{5/8}"
 flow rate: 2.2 gpm

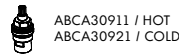

Polished Chrome **\$1195**

Custom Finish **\$2390**



X7613 3-piece deckmount tub filler with handshower

- solid brass construction
- recessed aerator – aerated water flow
- pressure balance volume control mixing valve
- handshower with 5' double-helix hidden hose
- 1/2" connection

height: 11"
 overall projection: 9^{3/4}"
 flow rate: (tub filler) 5 gpm (handshower) 2.5 gpm



Polished Chrome **\$1195**

Custom Finish **\$2390**



X7713 3-piece deckmount tub filler with handshower

- solid brass construction
- recessed aerator – aerated water flow
- pressure balance volume control mixing valve
- handshower with 5' double-helix hidden hose
- 1/2" connection

height: 11^{5/16}"
 overall projection: 6^{3/4}"
 flow rate: (tub filler) 5 gpm (handshower) 2.5 gpm



Polished Chrome **\$1195**

Custom Finish **\$2390**



X7626 4 hole bidet set

- solid brass construction
- incorporated vacuum breaker and vertical spray
- mechanical drain included
- 1/2" connection

height: 4^{11/16}"
 flow rate: full flow

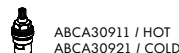

Polished Chrome **\$1350**

Custom Finish **\$2700**



MARMO

TOSCA

OTTO

VITTORIO

REGENCY

ETNA

CUT

XSQUARE

X7826 4 hole bidet set



- solid brass construction
- incorporated vacuum breaker and vertical spray
- mechanical drain included
- 1/2" connection

height: 4^{11/16"}
flow rate: full flow

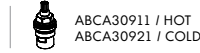
Polished Chrome **\$1350**Custom Finish **\$2700**

MB2

XROUND

GEO

TIME

BLOK

VOLARE

FOLIA

X76N85 floormount tub filler with handshower



- solid brass construction
- recessed aerator – aerated water flow
- handshower with 5' double-helix brass hose
- rough-in not included, order #92189
- 1/2" female connection with quick connect

height: 37"
overall projection: 9^{3/4"}
flow rate: (tub filler) 5 gpm
(handshower) 2.5 gpm

Polished Chrome **\$2995**Custom Finish **\$5990**

MIDTOWN

MUST

BLADE

LOVEME

ALPHA

METRO

CHICANE

92189 rough-in for wallmount tub filler X76N85



- 1/2" NPT male connection

Rough-in **\$595**

B-JOU

MADISON

XSQUARE

STREEM

SOLO

X76N95 floormount tub filler with handshower



- solid brass construction
- recessed aerator – aerated water flow
- handshower with 5' double-helix brass hose
- rough-in not included, order #92189
- 1/2" female connection with quick connect

height: 37^{1/2"}
overall projection: 14^{7/8"}
flow rate: (tub filler) 5 gpm
(handshower) 2.5 gpm

Polished Chrome **\$3195**Custom Finish **\$6390**

92189 rough-in for wallmount tub filler X76N95



- 1/2" NPT male connection

Rough-in **\$595**



X77N85 floormount tub filler with handshower

- solid brass construction
- recessed aerator – aerated water flow
- handshower with 5' double-helix hose
- rough-in not included, order #**92189**
- 1/2" female connection with quick connect

Polished Chrome **\$2995**

Custom Finish **\$5990**

height: 38^{1/4}"
 overall projection: 7"
 flow rate: (tub filler) 5 gpm
 (handshower) 2.5 gpm



92189 rough-in for wallmount tub filler X77N85

- 1/2" NPT male connection

Rough-in **\$595**



Shower Valves & Trim Set Solutions

(for complete program, see pages 241 - 292)



S3095 plate and handle trim set

- 4^{1/4}"x7^{7/8}"x1/8"
- requires # 12000 TURBO thermostatic valve with a choice of a shut-off valve (# 1206) or a 2-3 way diverter (# 61934)

Polished Chrome **\$195**

Custom Finish **\$390**

T12000 TURBO thermostatic valve 3/4" - 1/2"

Rough **\$455**



S0695 plate and handle trim set

- 3^{1/4}"x4^{1/4}"x1/8"
- requires # 1206 shut-off valve

Polished Chrome **\$160**

Custom Finish **\$205**

1206 1/2" shut-off valve

Rough **\$165**



MARMO

TOSCA

OTTO

VITTORIO

REGENCY

ETNA

CUT

XSQUARE



2-way

93923 plate and handle trim set with 2-way diverter**• WITH STOP – shared functions**

- replaces the functionality of 2 shut-off valves
- 2^{3/4"} x 2^{3/4"} x 1/8"
- requires # 61934 diverter

Polished Chrome

\$275

Custom Finish

\$550**61934 2 & 3 way diverter**

Rough

\$195

2-way

93823 plate and handle trim set with 2-way diverter**• WITH STOP – 1 function at a time**

- replaces the functionality of 2 shut-off valves
- 2^{3/4"} x 2^{3/4"} x 1/8"
- requires # 61934 diverter

Polished Chrome

\$275

Custom Finish

\$550**61934 2 & 3 way diverter**

Rough

\$195

3-way

93933 plate and handle trim set with 3-way diverter**• WITH STOP – shared functions**

- replaces the functionality of 3 shut-off valves
- 2^{3/4"} x 2^{3/4"} x 1/8"
- requires # 61934 diverter

Polished Chrome

\$275

Custom Finish

\$550**61934 2 & 3 way diverter**

Rough

\$195

3-way

93833 plate and handle trim set with 3-way diverter**• WITH STOP – 1 function at a time**

- replaces the functionality of 3 shut-off valves
- 2^{3/4"} x 2^{3/4"} x 1/8"
- requires # 61934 diverter

Polished Chrome

\$275

Custom Finish

\$550**61934 2 & 3 way diverter**

Rough

\$195**S3195 plate and handle trim set**

- 4^{1/4"} x 11" x 1/8"

- requires # 12001 TURBO thermostatic valve

Polished Chrome

\$340

Custom Finish

\$680**T12001 TURBO thermostatic valve with 1 shut-off valve - 3/4" - 1/2"**

Rough

\$625

B-JOU











MADISON

XSQUARE

STREEM

SOLO

DRAINS

 	S3295 plate and handle trim set • 4 ^{1/4} "x13 ^{3/4} "x1/8" • requires # 12002 TURBO thermostatic valve	Polished Chrome	\$490
	T12002 TURBO thermostatic valve with 2 shut-off valve - 3/4" - 1/2"	Rough	\$795
 	S3395 plate and handle trim set • 4 ^{1/4} "x16 ^{3/4} "x1/8" • requires # 12003 TURBO thermostatic valve	Polished Chrome	\$645
	T12003 TURBO thermostatic valve with 3 shut-off valve - 3/4" - 1/2"	Rough	\$965
 	S3495 plate and handle trim set • 4 ^{1/4} "x19 ^{5/8} "x1/8" • requires # 12004 TURBO thermostatic valve	Polished Chrome	\$795
	T12004 TURBO thermostatic valve with 4 shut-off valve - 3/4" - 1/2"	Rough	\$1135
 	S8295 plate and handle trim set with 2-way diverter • shared functions • 4 ^{1/4} "x12"x1/8" • requires #T12123 Turbo Uniplex thermostatic valve	Polished Chrome	\$455
	T12123 TURBO UNIPLEX thermostatic valve 3/4" - 1/2"	Rough	\$495
2-way			
 	S9295 plate and handle trim set with 2-way diverter • 1 function at a time • 4 ^{1/4} "x12"x1/8" • requires #T12123 Turbo Uniplex thermostatic valve	Polished Chrome	\$455
	T12123 TURBO UNIPLEX thermostatic valve 3/4" - 1/2"	Rough	\$495
2-way			



MARMO

TOSCA

OTTO

VITTORIO

REGENCY

ETNA

CUT

XSQUARE



3-way

- S8395 plate and handle trim set with 3-way diverter**
- shared functions
 - 4^{1/4}"x12"x1/8"
 - requires #T12123 Turbo Uniplex thermostatic valve

Polished Chrome **\$455**
 Custom Finish **\$910**

T12123 TURBO UNIPLEX thermostatic valve 3/4" - 1/2" Rough **\$495**



3-way

- S9395 plate and handle trim set with 3-way diverter**
- 1 function at a time
 - 4^{1/4}"x12"x1/8"
 - requires #T12123 Turbo Uniplex thermostatic valve

Polished Chrome **\$455**
 Custom Finish **\$910**

T12123 TURBO UNIPLEX thermostatic valve 3/4" - 1/2" Rough **\$495**



- S4095 plate and handle trim set**
- 6^{1/2}"x8^{1/4}"x1/8"
 - requires #40255 pressure balance valve

Polished Chrome **\$165**
 Custom Finish **\$330**

- 40255 1/2" pressure balance valve for shower**
- due to visible rough parts, select matching finish

Polished Chrome **\$235**
 Custom Finish **\$470**



- S4295 plate and handle trim set**
- 6^{1/2}"x8^{1/4}"x1/8"
 - requires #42355 pressure balance valve

Polished Chrome **\$195**
 Custom Finish **\$390**

- 42355 1/2" pressure balance valve for tub / shower**
- due to visible rough parts, select matching finish

Polished Chrome **\$425**
 Custom Finish **\$850**



B-JOU

MADISON

XSQUARE

STREEM

SOLO

DRAINS



MARMO

TOSCA

OTTO

VITTORIO

REGENCY

ETNA

CUT



MB2

XROUND

GEO

TIME

BLOK

VOLARE

FOLIA



MIDTOWN

MUST

BLADE

LOVEME

ALPHA

METRO

CHICANE



B-JOU

MADISON

X SQUARE

STREEM

SOLO

DRAINS

STREEM

AVAILABLE FINISH

polished chrome

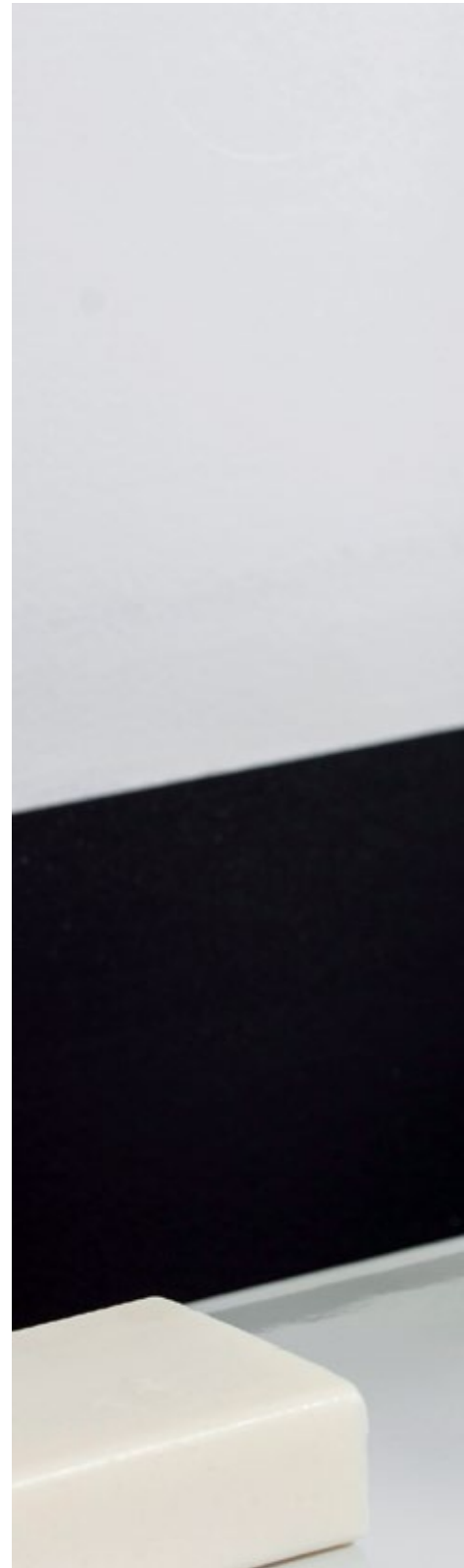





MARMO

TOSCA

OTTO

VITTORIO

REGENCY

ETNA

CUT

STREEM

77314 single-hole lavatory faucet

Polished Chrome

\$595

- solid brass construction
- cascading water flow
- press pop-up drain with overflow included
- 3/8" connection

height: 6^{5/8"}
 overall projection: 5^{5/16"}
 flow rate: 2 gpm



ABCA07799

77320 tall single-hole lavatory faucet

Polished Chrome

\$895

- solid brass construction
- cascading water flow
- press pop-up drain with overflow included
- 3/8" connection

height: 11^{1/4"}
 overall projection: 7^{1/2"}
 flow rate: 2 gpm



ABCA07799

77N29 wallmount lavatory faucet

Polished Chrome

\$745

- solid brass construction
- cascading water flow
- drain not included, see page 212 for options
- rough-in not included, order # **CB029**

height: (w/ plate) 4^{3/8"}
 overall projection: 7^{1/4"}
 flow rate: 2 gpm



ABCA07798



ABSPEX2206 (PC)

CB029 rough-in for wallmount faucet # 77N29

Rough-in

\$295

- 1/2" NPT connection

**77313 3-piece deckmount tub filler with handshower**

Polished Chrome

\$995

- solid brass construction
- cascading water flow
- pressure balance volume control mixing valve
- handshower with 5' double-helix hidden hose
- 1/2" connection

height: 8^{1/4"}
 overall projection: 8^{1/4"}
 flow rate: (tub filler) 5.5 gpm (handshower) 2.5 gpm



ABCA74599



MB2

XROUND

GEO

TIME

BLOK

VOLARE

FOLIA



MIDTOWN

MUST

BLADE

LOVEME

ALPHA

METRO

CHICANE



B-JOU

MADISON

XSQUARE

STREEM

SOLO

DRAINS

Shower Valves & Trim Set Solutions

(for complete program, see pages 241 - 292)



S3095 plate and handle trim set

Polished Chrome **\$195**

- 4^{1/4}"x7^{7/8}"x1/8"
- requires # 12000 TURBO thermostatic valve with a choice of a shut-off valve (# 1206) or a 2-3 way diverter (# 61934)

T12000 TURBO thermostatic valve 3/4" - 1/2"

Rough **\$455**



S0695 plate and handle trim set

Polished Chrome **\$160**

- 3^{1/4}"x4^{1/4}"x1/8"
- requires # 1206 shut-off valve

1206 1/2" shut-off valve

Rough **\$165**



2-way

93923 plate and handle trim set with 2-way diverter

Polished Chrome **\$275**

- **WITH STOP – shared functions**
- replaces the functionality of 2 shut-off valves
- 2^{3/4}" x 2^{3/4}" x 1/8"
- requires # 61934 diverter

61934 2 & 3 way diverter

Rough **\$195**



2-way

93823 plate and handle trim set with 2-way diverter

Polished Chrome **\$275**

- **WITH STOP – 1 function at a time**
- replaces the functionality of 2 shut-off valves
- 2^{3/4}" x 2^{3/4}" x 1/8"
- requires # 61934 diverter

61934 2 & 3 way diverter

Rough **\$195**



MARMO

TOSCA

OTTO

VITTORIO

REGENCY

ETNA

CUT

STREEM



3-way

93933 plate and handle trim set with 3-way diverter

Polished Chrome

\$275**• WITH STOP – shared functions**

- replaces the functionality of 3 shut-off valves
- 2^{3/4"} x 2^{3/4"} x 1/8"
- requires # 61934 diverter

61934 2 & 3 way diverter

Rough

\$195

3-way

93833 plate and handle trim set with 3-way diverter

Polished Chrome

\$275**• WITH STOP – 1 function at a time**

- replaces the functionality of 3 shut-off valves
- 2^{3/4"} x 2^{3/4"} x 1/8"
- requires # 61934 diverter

61934 2 & 3 way diverter

Rough

\$195**S3195 plate and handle trim set**

Polished Chrome

\$340

- 4^{1/4"} x 11" x 1/8"
- requires # 12001 TURBO thermostatic valve

T12001 TURBO thermostatic valve with 1 shut-off valve - 3/4" - 1/2"

Rough

\$625**S3295 plate and handle trim set**

Polished Chrome

\$490

- 4^{1/4"} x 13^{3/4"} x 1/8"
- requires # 12002 TURBO thermostatic valve

T12002 TURBO thermostatic valve with 2 shut-off valve - 3/4" - 1/2"

Rough

\$795**S3395 plate and handle trim set**

Polished Chrome

\$645

- 4^{1/4"} x 16^{3/4"} x 1/8"
- requires # 12003 TURBO thermostatic valve

T12003 TURBO thermostatic valve with 3 shut-off valve - 3/4" - 1/2"

Rough

\$965

MB2

XROUND

GEO

TIME

BLOK

VOLARE

FOLIA



MIDTOWN

MUST

BLADE

LOVEME

ALPHA

METRO

CHICANE



B-JOU

MADISON

XSQUARE

STREEM

SOLO

DRAINS



S3495 plate and handle trim set
 Polished Chrome **\$795**
 • 4^{1/4}"x19^{5/8}"x1/8"
 • requires #12004 TURBO thermostatic valve

T12004 TURBO thermostatic valve with 4 shut-off valve - 3/4" - 1/2"
 Rough **\$1135**



S8295 plate and handle trim set with 2-way diverter
 Polished Chrome **\$455**
 • shared functions
 • 4^{1/4}"x12"x1/8"
 • requires #T12123 Turbo Uniplex thermostatic valve

T12123 TURBO UNIPLEX thermostatic valve 3/4" - 1/2"
 Rough **\$495**

2-way



S9295 plate and handle trim set with 2-way diverter
 Polished Chrome **\$455**
 • 1 function at a time
 • 4^{1/4}"x12"x1/8"
 • requires #T12123 Turbo Uniplex thermostatic valve

T12123 TURBO UNIPLEX thermostatic valve 3/4" - 1/2"
 Rough **\$495**

2-way



S8395 plate and handle trim set with 3-way diverter
 Polished Chrome **\$455**
 • shared functions
 • 4^{1/4}"x12"x1/8"
 • requires #T12123 Turbo Uniplex thermostatic valve

T12123 TURBO UNIPLEX thermostatic valve 3/4" - 1/2"
 Rough **\$495**

3-way



S9395 plate and handle trim set with 3-way diverter
 Polished Chrome **\$455**
 • 1 function at a time
 • 4^{1/4}"x12"x1/8"
 • requires #T12123 Turbo Uniplex thermostatic valve

T12123 TURBO UNIPLEX thermostatic valve 3/4" - 1/2"
 Rough **\$495**

3-way



MARMO

TOSCA

OTTO

VITTORIO

REGENCY

ETNA

CUT

STREEM



S4095 plate and handle trim set

Polished Chrome

\$165

- 6^{1/2}"x8^{1/4}"x1/8"
- requires #40255 pressure balance valve

40255 1/2" pressure balance valve for shower

Polished Chrome

\$235

- due to visible rough parts, select matching finish



MB2

XROUND

GEO

TIME

BLOK

VOLARE

FOLIA



S4295 plate and handle trim set

Polished Chrome

\$195

- 6^{1/2}"x8^{1/4}"x1/8"
- requires #42355 pressure balance valve

42355 1/2" pressure balance valve for tub / shower

Polished Chrome

\$425

- due to visible rough parts, select matching finish



MIDTOWN

MUST

BLADE

LOVEME

ALPHA

METRO

CHICANE



B-JOU

MADISON

XSQUARE

STREEM

SOLO

DRAINS



MARMO

TOSCA

OTTO

VITTORIO

REGENCY

ETNA

CUT



MB2

XROUND

GEO

TIME

BLOK

VOLARE

FOLIA



MIDTOWN

MUST

BLADE

LOVEME

ALPHA

METRO

CHICANE



B-JOU

MADISON

XSQUARE

STREEM

SOLO

DRAINS

SOLO



TUBO

Polished Chrome
Black
Brushed Gold



HEY JOE

Polished Chrome



HOCKEY

Polished Chrome



KIKI

Polished Chrome
Electro Black



MARTINI

Polished Chrome



MINIME

Polished Chrome



STILETTO

Polished Chrome



STRING

Polished Chrome



TUBO - single-hole lavatory faucet #12014 featured in black



MARMO

TOSCA

OTTO

VITTORIO

REGENCY

ETNA

CUT

SOLO



12014 TUBO – single-hole lavatory faucet

- solid brass construction
- crystal clear water flow
- press pop-up drain with overflow included
- 3/8" connection

height: 6^{3/8"}
 overall projection: 6^{13/16"}
 flow rate: 1.75 gpm



ABCA66099

Polished Chrome **\$495**
 Black **\$645**
 Brushed Gold **\$745**



MB2

XROUND

GEO

TIME

BLOK

VOLARE

FOLIA



28014 HEY JOE – single-hole lavatory faucet

- solid brass construction
- aerated water flow
- press pop-up drain with overflow included
- 3/8" connection

height: 5^{7/8"}
 overall projection: 6^{5/16"}
 flow rate: 1.5 gpm



ABCA03240

Polished Chrome **\$635**



MIDTOWN

MUST

BLADE

LOVEME

ALPHA

METRO

CHICANE



81514 HOCKEY – single-hole lavatory faucet

- solid brass construction
- recessed aerator – aerated water flow
- press pop-up drain with overflow included
- 3/8" connection

height: 8^{1/4"}
 overall projection: 6^{9/16"}
 flow rate: 1.5 gpm



ABCA81599

Polished Chrome **\$425**



B-JOU

MADISON

XSQUARE

STREEM



45014 KIKI – single-hole lavatory faucet

- solid brass construction
- aerated water flow
- press pop-up drain with overflow included
- 3/8" connection

height: 6^{3/8"}
 overall projection: 6"
 flow rate: 1.5 gpm



ABCA04500

Polished Chrome **\$295**
 Electro Black **\$395**

SOLO

DRAINS



80914 MARTINI – single-hole lavatory faucet

Polished Chrome **\$845**

- solid brass construction
- cascading water flow
- press pop-up drain with overflow included
- 3/8" connection

height: 6^{7/8}"
 overall projection: 6^{5/16}"
 flow rate: 2.2 gpm



54014 MINIME – single-hole lavatory faucet

Polished Chrome **\$345**

- solid brass construction
- recessed aerator – aerated water flow
- press pop-up drain with overflow included
- 3/8" connection

height: 5^{1/16}"
 overall projection: 4^{3/8}"
 flow rate: 2.2 gpm



98014 STILETTO – single-hole lavatory faucet

Polished Chrome **\$745**

- solid brass construction
- recessed aerator – aerated water flow
- press pop-up drain with overflow included
- 3/8" connection

height: 6^{7/8}"
 overall projection: 5^{13/16}"
 flow rate: 1.5 gpm



17714 STRING – single-hole lavatory faucet

Polished Chrome **\$1275**

- solid brass construction
- 3 strings of aerated water flow
- press pop-up drain with overflow included
- 3/8" connection

height: 5^{5/8}"
 overall projection: 7^{1/4}"
 flow rate: 1.5 gpm





MARMO

TOSCA

OTTO

VITTORIO

REGENCY

ETNA

CUT

DRAINS & P-TRAPS

**699 round press pop-up drain**

- overflow included
- fits up to 2"

Polished Chrome **\$95**
 Brushed Nickel **\$125**
 Electro Black **\$125**
 Brushed Gold PVD **\$170**

✦ Custom Finish **\$190**

**698 round press pop-up drain**

- fits up to 2"

Polished Chrome **\$95**
 Brushed Nickel **\$125**

✦ Custom Finish **\$190**

**626 1^{1/4}" round press pop-up drain**

- overflow included
- fits up to 2"

Polished Chrome **\$110**
 Brushed Nickel **\$145**

✦ Custom Finish **\$220**

**627 1^{1/4}" round press pop-up drain**

- fits up to 2"

Polished Chrome **\$110**
 Brushed Nickel **\$145**

✦ Custom Finish **\$220**

**637 1^{1/4}" long round press pop-up drain**

- fits up to 2^{3/4}"

Polished Chrome **\$110**
 Brushed Nickel **\$145**

✦ Custom Finish **\$220**

**628 1^{1/4}" square press pop-up drain**

- overflow included
- fits up to 2"

Polished Chrome **\$135**
 Brushed Nickel **\$175**

✦ Custom Finish **\$270**



MB2

XROUND

GEO

TIME

BLOK

VOLARE

FOLIA



MIDTOWN

MUST

BLADE

LOVEME

ALPHA

METRO

CHICANE



B-JOU

MADISON

XSQUARE

STREEM

SOLO

DRAINS & P-TRAPS



629 1 1/4" square press pop-up drain
 • fits up to 2"

- Polished Chrome **\$135**
- Brushed Nickel **\$175**
- ✦ Custom Finish **\$270**



638 1 1/4" long square press pop-up drain
 • fits up to 2"

- Polished Chrome **\$135**
- Brushed Nickel **\$175**
- ✦ Custom Finish **\$270**



42300 1 1/4" mechanical drain
 • overflow included
 • fits up to 2"

- Polished Chrome **\$105**
- Brushed Nickel **\$135**
- ✦ Custom Finish **\$210**



2454 1 1/4" round p-trap

- Polished Chrome **\$185**
- Brushed Nickel **\$240**
- Electro Black **\$325**
- Brushed Gold **\$325**
- ✦ Custom Finish **\$370**

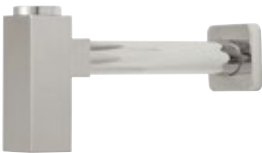

2464 1 1/4" square p-trap

- Polished Chrome **\$230**
- Brushed Nickel **\$295**
- Electro Black **\$395**
- Brushed Gold **\$395**
- ✦ Custom Finish **\$460**

- ∞
- MARMO
- TOSCA
- OTTO
- VITTORIO
- REGENCY
- ETNA
- CUT

-
- MB2
- XROUND
- GEO
- TIME
- BLOK
- VOLARE
- FOLIA

- ◻
- MIDTOWN
- MUST
- BLADE
- LOVEME
- ALPHA
- METRO
- CHICANE

- ◻
- B-JOU
- MADISON
- XSQUARE
- STREEM

- SOLO

SHOWER



Photo credit: Tomlenovich Design, photography by Giorgio Locatelli

SHOWER FAUCETS

Included:
ceiling arm



1-FUNCTION RAINHEAD

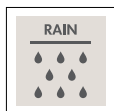

PUSH BUTTON 3-FUNCTION HANDSHOWER

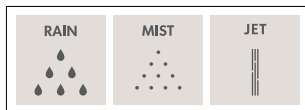

SF-U-01 Shower faucet U1

- thermostatic valve Uniplex 3/4" - 1/2"
- 2-way diverter, **2 functions working simultaneously**
- round solid brass trim set with handles
- 18" round shower arm & flange
- 4" round arm included for ceiling installation
- 10" round rainhead
- 3-function round shower rail (rain, mist, jet)
- adjustable round waterway

Polished Chrome **\$1550**
Brushed Nickel **\$1830**

SF-U-01G Shower faucet U1G CalGreen compliant option

- same components as above with a 2-way diverter, **one function at a time**

Polished Chrome **\$1550**
Brushed Nickel **\$1830**

SHOWER FAUCETS

Included:
ceiling arm

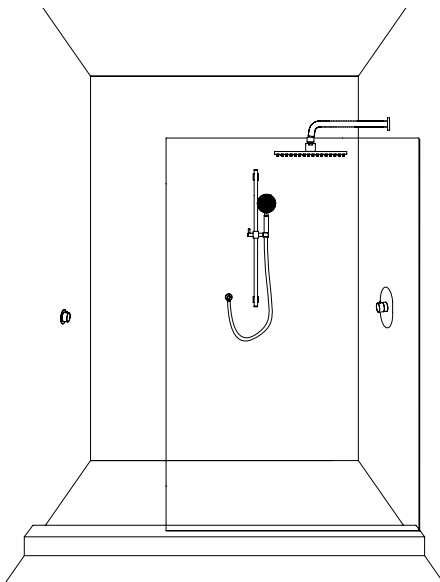

Configuration example for an optimal installation of the independent diverter (access the on/off control from outside the shower)



1-FUNCTION
RAINHEAD

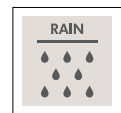

PUSH BUTTON 3-FUNCTION HANDSHOWER

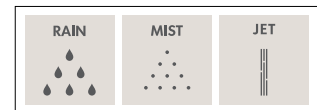

SF-D-01 Shower faucet D1

- thermostatic valve 3/4" - 1/2"
- 2-way independent diverter, **2 functions working simultaneously** with on/off contrôle
- round solid brass trim sets with handles
- 18" round shower arm & round flange
- 4" round arm included for ceiling installation
- 10" round rainhead
- 3-function round shower rail (rain, mist, jet)
- adjustable round waterway

Polished Chrome **\$1750**
Brushed Nickel **\$2020**

SF-D-01G Shower faucet D1G CalGreen compliant option

- same components as above with a 2-way independent diverter, **one function at a time**

Polished Chrome **\$1750**
Brushed Nickel **\$2020**

SHOWER FAUCETS

Included:
ceiling arm



1-FUNCTION RAINHEAD

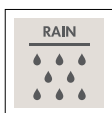

PUSH BUTTON 3-FUNCTION HANDSHOWER

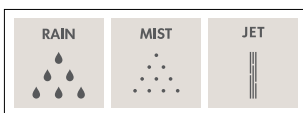

SF-U-02 Shower faucet U2

- thermostatic valve Uniplex 3/4" – 1/2"
- 2-way diverter, **2 functions working simultaneously**
- square solid brass trim set with handles
- 18" round shower arm & square flange
- 4" round arm included for ceiling installation
- 10" square rainhead
- 3-function square shower rail (rain, mist, jet)
- adjustable square waterway

Polished Chrome **\$1854**

Brushed Nickel **\$2245**

SF-U-02G Shower faucet U2G CalGreen compliant option

- same components as above with a
2-way diverter, **one function at a time**

Polished Chrome **\$1854**

Brushed Nickel **\$2245**

SHOWER FAUCETS

Included:
ceiling arm

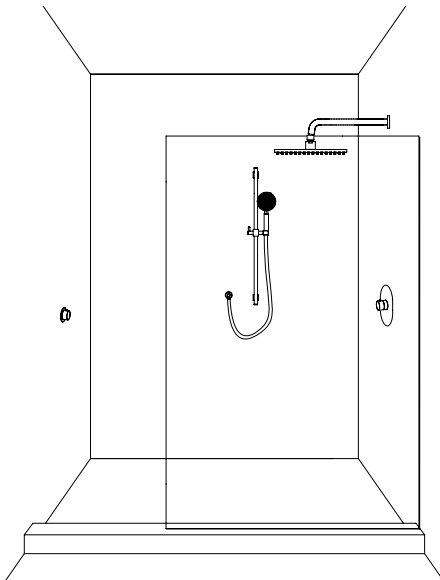

Configuration example for an optimal installation of the independent diverter (access the on/off control from outside the shower)



1-FUNCTION
RAINHEAD

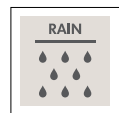

PUSH BUTTON 3-FUNCTION HANDSHOWER

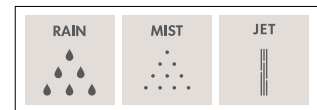

SF-D-02 Shower faucet D2

- thermostatic valve 3/4" - 1/2"
- 2-way independent diverter, **2 functions working simultaneously**
- square solid brass trim sets with handles
- 18" round shower arm & square flange
- 4" round arm included for ceiling installation
- 10" square rainhead
- 3-function square shower rail (rain, mist, jet)
- adjustable square waterway

Polished Chrome **\$2024**
Brushed Nickel **\$2390**

SF-D-02G Shower faucet D2G CalGreen compliant option

- same components as above with a 2-way independent diverter, **one function at a time**

Polished Chrome **\$2024**
Brushed Nickel **\$2390**

SHOWER FAUCETS

Included:
ceiling arm



1-FUNCTION
RAINHEAD

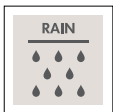

1-FUNCTION
HANDSHOWER

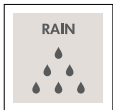

SF-U-03 Shower faucet U3

- thermostatic valve Uniplex 3/4" – 1/2"
- 2-way diverter, **2 functions working simultaneously**
- round solid brass trim set with handles
- 18" round shower arm & flange
- 4" round arm included for ceiling installation
- 10" round rainhead
- round handshower set with braided hose

Polished Chrome **\$1535**
Brushed Nickel **\$1840**

SF-U-03G Shower faucet U3G CalGreen compliant option

- same components as above with a 2-way diverter, **one function at a time**

Polished Chrome **\$1535**
Brushed Nickel **\$1840**

SHOWER FAUCETS

Included:
ceiling arm

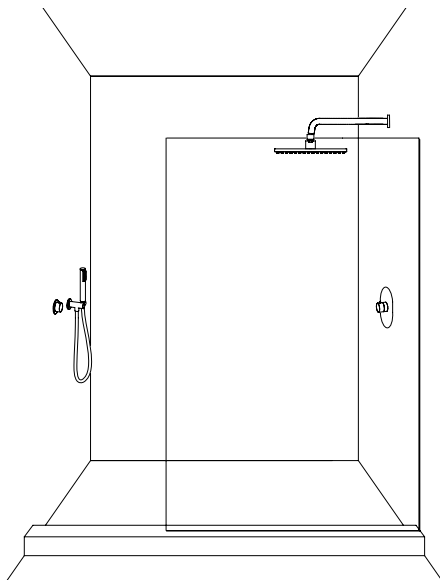

Configuration example for an optimal installation of the independent diverter (access the on/off control from outside the shower)



1-FUNCTION
RAINHEAD

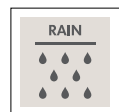

1-FUNCTION
HANDSHOWER

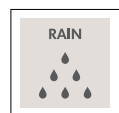

SF-D-03 Shower faucet D3

- thermostatic valve 3/4" – 1/2"
- 2-way independent diverter, **2 functions working simultaneously**
- round solid brass trim sets with handles
- 18" round shower arm & flange
- 4" round arm included for ceiling installation
- 10" round rainhead
- round handshower set with braided hose

Polished Chrome **\$1735**
Brushed Nickel **\$2030**

SF-D-03G Shower faucet D3G CalGreen compliant option

- same components as above with a 2-way independent diverter, **one function at a time**

Polished Chrome **\$1735**
Brushed Nickel **\$2030**

SHOWER FAUCETS

Included:
ceiling arm



1-FUNCTION
RAINHEAD

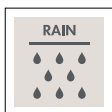

1-FUNCTION
HANDSHOWER

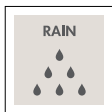

SF-U-04 Shower faucet U4

- thermostatic valve 3/4" – 1/2"
- 2-way independent diverter, **2 functions working simultaneously**
- square solid brass trim sets with handles
- 18" round shower arm & square flange
- 4" round arm included for ceiling installation
- 10" square rainhead
- square handshower set with braided hose

Polished Chrome **\$1859**
Brushed Nickel **\$2270**

SF-U-04G Shower faucet U4G CalGreen compliant option

- same components as above with a 2-way diverter, **one function at a time**

Polished Chrome **\$1859**
Brushed Nickel **\$2270**

SHOWER FAUCETS

Included:
ceiling arm

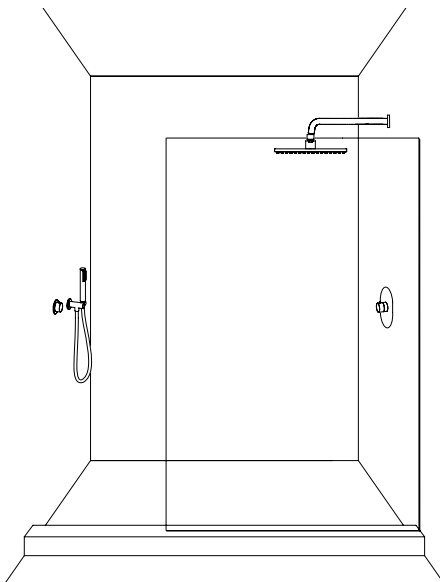

Configuration example for an optimal installation of the independent diverter (access the on/off control from outside the shower)



1-FUNCTION
RAINHEAD

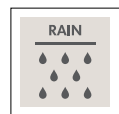

1-FUNCTION
HANDSHOWER

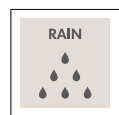

SF-D-04 Shower faucet D4

- thermostatic valve 3/4" – 1/2"
- 2-way independent diverter, **2 functions working simultaneously**
- square solid brass trim sets with handles
- 18" round shower arm & square flange
- 4" round arm included for ceiling installation
- 10" square rainhead
- square handshower set with braided hose

Polished Chrome **\$2029**

Brushed Nickel **\$2415**

SF-D-04G Shower faucet D4G CalGreen compliant option

- same components as above with a 2-way independent diverter, **one function at a time**

Polished Chrome **\$2029**

Brushed Nickel **\$2415**

SHOWER FAUCETS

Included:
ceiling arm



1-FUNCTION RAINHEAD

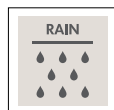

PUSH BUTTON 3-FUNCTION HANDSHOWER

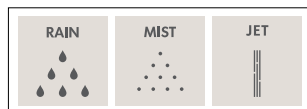

1-FUNCTION BODY JET



SF-U-05 Shower faucet U5

- thermostatic valve Uniplex 3/4" – 1/2"
- 3-way diverter, **2 functions working simultaneously**
- round solid brass trim set with handles
- 18" round shower arm & flange
- 4" round arm included for ceiling installation
- 10" round rainhead
- 3-function round shower rail (rain, mist, jet)
- adjustable round waterway
- 2 round spin body jets

Polished Chrome **\$1940**
Brushed Nickel **\$2500**

SF-U-05G Shower faucet U5G CalGreen compliant option

- same components as above with a 3-way diverter, **one function at a time**

Polished Chrome **\$1940**
Brushed Nickel **\$2500**

SHOWER FAUCETS

Included:
ceiling arm



1-FUNCTION
RAINHEAD

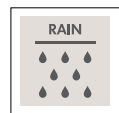

PUSH BUTTON 3-FUNCTION HANDSHOWER

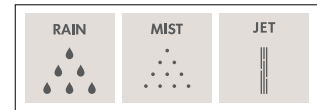

1-FUNCTION
BODY JET



SF-U-06 Shower faucet U6

- thermostatic valve Uniplex 3/4" – 1/2"
- 3-way diverter, **2 functions working simultaneously**
- square solid brass trim set with handles
- 18" round shower arm & square flange
- 4" round arm included for ceiling installation
- 10" square rainhead
- 3-function square shower rail (rain, mist, jet)
- adjustable square waterway
- 2 square spin body jets

Polished Chrome **\$2304**
Brushed Nickel **\$3035**

SF-U-06G Shower faucet U6G CalGreen compliant option

- same components as above with a 3-way diverter, **one function at a time**

Polished Chrome **\$2304**
Brushed Nickel **\$3035**

SHOWER FAUCETS

Included:
ceiling arm



1-FUNCTION RAINHEAD

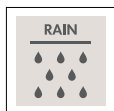

PUSH BUTTON 3-FUNCTION HANDSHOWER

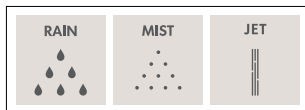

SF-U-07 Shower faucet U7

- thermostatic valve Uniplex 3/4" – 1/2"
- 3-way diverter, **2 functions working simultaneously**
- round solid brass trim set with handles
- 18" round shower arm & flange
- 4" round arm included for ceiling installation
- 10" round rainhead
- 3-function round shower rail (rain, mist, jet)
- adjustable round waterway
- 7" round tub spout

Polished Chrome **\$1655**
Brushed Nickel **\$1965**

SF-U-07G Shower faucet U7G
CalGreen compliant option

- same components as above with a 3-way diverter, **one function at a time**

Polished Chrome **\$1655**
Brushed Nickel **\$1965**

SHOWER FAUCETS

Included:
ceiling arm



1-FUNCTION RAINHEAD

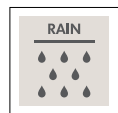

PUSH BUTTON 3-FUNCTION HANDSHOWER

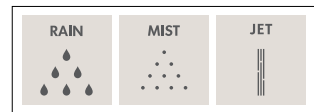

SF-U-08 Shower faucet U8

- thermostatic valve Uniplex 3/4" – 1/2"
- 3-way diverter, **2 functions working simultaneously**
- square solid brass trim set with handles
- 18" round shower arm & square flange
- 4" round arm included for ceiling installation
- 10" square rainhead
- 3-function square shower rail (rain, mist, jet)
- adjustable square waterway
- 7" square tub spout

Polished Chrome **\$1999**
Brushed Nickel **\$2430**

SF-U-08G Shower faucet U8G CalGreen compliant option

- same components as above with a 3-way diverter, **one function at a time**

Polished Chrome **\$1999**
Brushed Nickel **\$2430**

SHOWER FAUCETS



1-FUNCTION HANDSHOWER

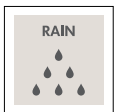

SF-D-05 Shower faucet D5

- thermostatic valve 3/4" – 1/2"
- independent 2-way diverter, **2 functions working simultaneously**
- round solid brass trim sets with handles
- round handshower set with braided hose
- 7" square tub spout

Polished Chrome **\$1425**

Brushed Nickel **\$1630**

SF-D-05G Shower faucet D5G CalGreen compliant option

- same components as above with a
2-way independent diverter, **one function at a time**

Polished Chrome **\$1425**

Brushed Nickel **\$1630**

SHOWER FAUCETS



**1-FUNCTION
HANDSHOWER**

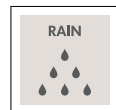

SF-D-06 Shower faucet D6

- thermostatic valve 3/4" – 1/2"
- independent 2-way diverter, **2 functions working simultaneously**
- square solid brass trim sets with handles
- square handshower set with braided hose
- 7" square tub spout

Polished Chrome **\$1590**
Brushed Nickel **\$1840**

**SF-D-06G Shower faucet D6G
CalGreen compliant option**

- same components as above with a 2-way independent diverter, **one function at a time**

Polished Chrome **\$1590**
Brushed Nickel **\$1840**

SHOWER FAUCETS

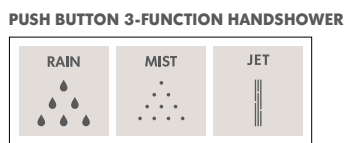
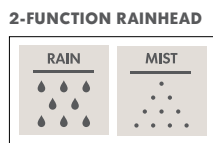
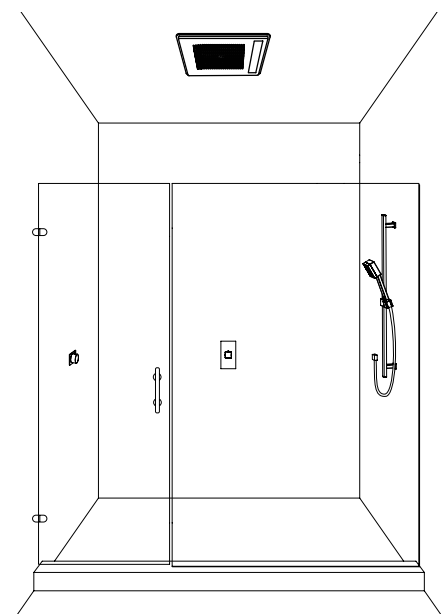

Configuration example for an optimal installation of the independent diverter (access the on/off control from outside the shower)

SF-D-07 Shower faucet D7

Polished Chrome **\$2730**

- thermostatic valve 3/4" – 1/2"
- independent 3-way diverter, **2 functions working simultaneously**
- round solid brass trim sets with handles
- CURA 12" x 8" recessed rainhead – 2 functions (rain, mist)
- chromatherapy
- 3-function round shower rail (rain, mist, jet)
- adjustable round waterway

SF-D-07G Shower faucet D7G CalGreen compliant option

Polished Chrome **\$2730**

- same components as above with a 3-way independent diverter, **one function at a time**

SHOWER FAUCETS

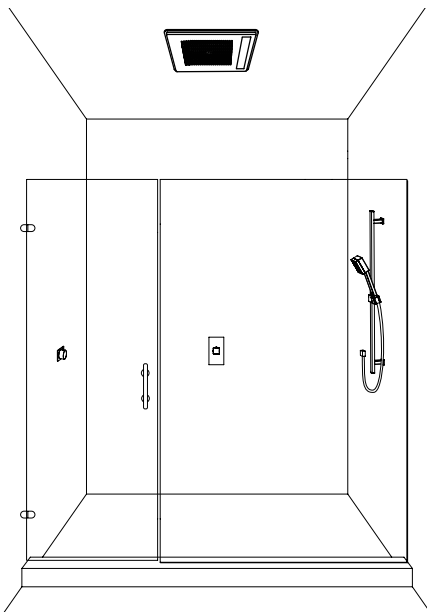

Configuration example for an optimal installation of the independent diverter (access the on/off control from outside the shower)



2-FUNCTION RAINHEAD

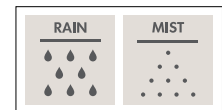

PUSH BUTTON 3-FUNCTION HANDSHOWER

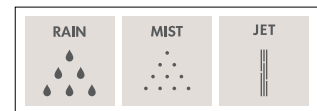

waterproof wallmount remote control for chromatherapy included

SF-D-08 Shower faucet D8

Polished Chrome **\$2835**

- thermostatic valve 3/4" - 1/2"
- independent 3-way diverter, **2 functions working simultaneously**
- square solid brass trim sets with handles
- CURA 12" x 8" recessed rainhead - 2 functions (rain, mist)
- chromatherapy
- 3-function square shower rail (rain, mist, jet)
- adjustable square waterway

SF-D-08G Shower faucet D8G CalGreen compliant option

Polished Chrome **\$2835**

- same components as above with a 3-way independent diverter, **one function at a time**

SHOWER FAUCETS

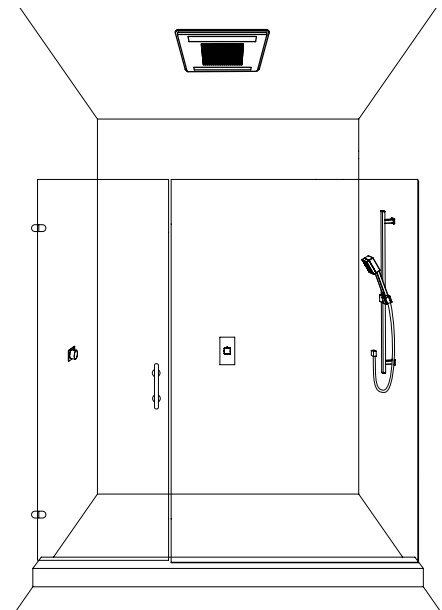

Configuration example for an optimal installation of the independent diverter (access the on/off control from outside the shower)

1-FUNCTION RAINHEAD

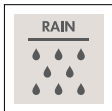

PUSH BUTTON 3-FUNCTION HANDSHOWER

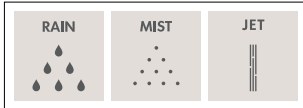

waterproof wallmount remote control for chromatherapy included

SF-D-09 Shower faucet D9

Polished Chrome **\$5130**

- thermostatic valve 3/4" – 1/2"
- independent 2-way diverter, **2 functions working simultaneously**
- round solid brass trim set with handles
- CURA 24" x 18" recessed rainhead – 1 function (rain)
- chromatherapy
- 3-function round shower rail (rain, mist, jet)
- adjustable round waterway

SF-D-09G Shower faucet D9G CalGreen compliant option

Polished Chrome **\$5130**

- same components as above with a 2-way independent diverter, **one function at a time**

SHOWER FAUCETS

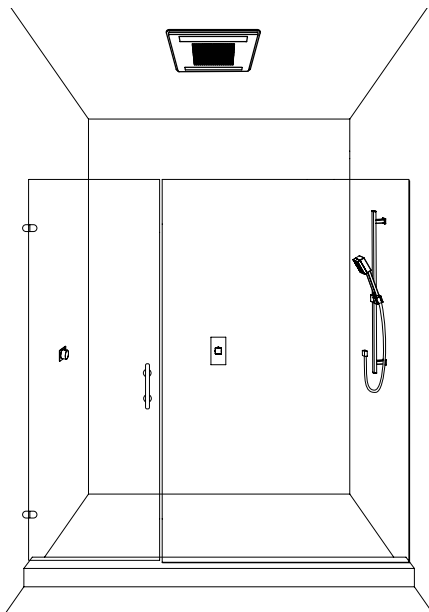

Configuration example for an optimal installation of the independent diverter (access the on/off control from outside the shower)



1-FUNCTION RAINHEAD

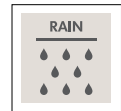

PUSH BUTTON 3-FUNCTION HANDSHOWER

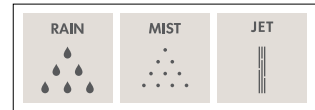

waterproof wallmount remote control for chromatherapy included

SF-D-10 Shower faucet D10

Polished Chrome **\$5235**

- thermostatic valve 3/4" - 1/2"
- independent 2-way diverter, **2 functions working simultaneously**
- square solid brass trim set with handles
- CURA 24" x 18" recessed rainhead - 1 function (rain)
- chromatherapy
- 3-function square shower rail (rain, mist, jet)
- adjustable square waterway

SF-D-10G Shower faucet D10G CalGreen compliant option

Polished Chrome **\$5235**

- same components as above with a 2-way independent diverter, **one function at a time**

SHOWER FAUCETS

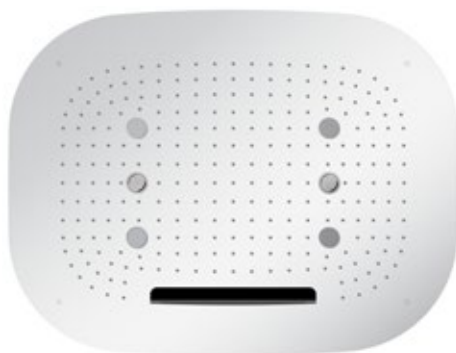

3-FUNCTION RAINHEAD

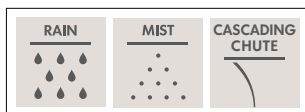

PUSH BUTTON 3-FUNCTION HANDSHOWER

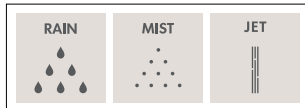

waterproof wallmount remote control
for chromatherapy included

SF-T-01 Shower faucet T1

Polished Chrome

\$6645

- thermostatic valve 3/4" – 1/2" with 4 shut-off valves
- round solid brass trim set with handles
- CURA 25" x 19" recessed rainhead – 3 functions (rain, mist, cascading chute)
- chromatherapy
- 3-function round shower rail (rain, mist, jet)
- adjustable round waterway

SHOWER FAUCETS



SF-T-02 Shower faucet T2

- thermostatic valve 3/4" – 1/2" with 5 shut-off valves
- square solid brass trim set with handles
- CURA 22" x 15" recessed rainhead – 3 functions (rain, mist, rain chute)
- chromatherapy
- cascading chute
- 3-function square shower rail (rain, mist, jet)
- adjustable square waterway

Polished Chrome **\$11390**

SHOWER COLUMNS



1-FUNCTION RAINHEAD

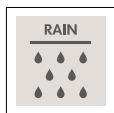

3-FUNCTION HANDSHOWER



52N35 PILA 1/2" thermostatic shower column

- solid brass construction
- 1/2" thermostatic valve with on/off 2-way diverter
- 10" rainhead
- 3 functions handshower: rain, massage, massage/rain
- 5' to 6' expandable braided hose
- 1/2" NPT male connection
- adjustable sliding handshower hook

height: 38^{1/2"}

projection: 18^{9/16"}

flow rate: 2.5 gpm / function

Polished Chrome

\$999

Electro Black

\$1295

SHOWER COLUMNS



Pivoting spout

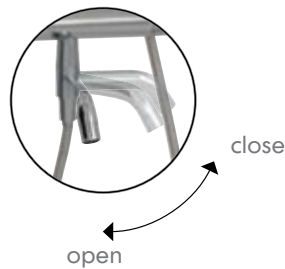

1-FUNCTION RAINHEAD

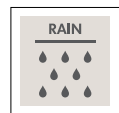

3-FUNCTION HANDSHOWER



62335 TILA 1/2" thermostatic tub/shower column

- solid brass construction
- 1/2" thermostatic valve with 2-way diverter
- pivoting diverter tub spout
- 10" rainhead
- 3 functions handshower: rain, massage, massage/rain
- 5' to 6' expandable braided hose
- 1/2" NPT male connection
- adjustable sliding handshower hook

height: 61 13/16"

projection: 22 1/2"

flow rate: 2 gpm (rainhead and handshower) 6 gpm (tub spout)

Polished Chrome

\$1099

SHOWER COLUMNS



1-FUNCTION RAINHEAD

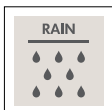

5-FUNCTION HANDSHOWER



52635 TEKNO 1/2" thermostatic shower column

- **stainless steel construction, suitable for indoor / outdoor installation**

- 1/2" thermostatic valve with on/off 2-way diverter
- 8" rainhead
- 5 functions handshower: rain, rain / massage, massage, massage / jet, jet
- 5' reinforced pvc hose
- 1/2" NPT male connection
- adjustable sliding handshower hook

height: 38^{1/4"}

projection: 17^{3/4"}

flow rate: 2.5 gpm / function

Polished Stainless Steel **\$2295**

Brushed Stainless Steel **\$2295**

A photograph of a bathroom featuring black subway tiles with a raised, rectangular pattern. A white window with a silver frame is centered in the upper half of the image. To the right, a brass showerhead is mounted on the wall. In the lower right corner, a brass faucet and handles are visible above a white bathtub. The text 'À LA CARTE' is overlaid in the center in a large, white, sans-serif font.

À LA CARTE

Photo credit: Jerry Hooker, Mirador Group, Houston, Texas



THERMOSTATIC VALVES 3/4" - 1/2"

TURBO, AQUABRASS' NEW GENERATION OF THERMOSTATIC VALVES

SUPERIORITY IN CRAFTSMANSHIP AND POWER WITH
UNIVERSAL INLET CONNECTIONS - 3/4" AND 1/2"

Removable NPT plug at the top of the valve to connect an additional shut-off valve (#1206) or an independent diverter (#61934) with stop

Note: The TURBO valve #12004 doesn't offer this feature

Adaptable shut-off valves outlets for a connection on the right, left, or both sides simultaneously

Safe, reliable and precise thermostatic cartridge by French label Vernet, that includes a safety cut-off feature in the event of a cold water failure

Flow rate: 12gpm at 45psi /
15gpm at 75psi

Italian made nickel plated solid brass rough

Fed from beneath, the TURBO thermostatic valves are equipped with universal inlets for 3/4" and 1/2" connections

Built-in female thread for 3/4" connections and male threads for 1/2" connections

Reversible service check valves with filters and improved stop mechanism, allowing for an efficient and easy back to back installation

1/2" connection

3/4" connection

THERMOSTATIC VALVES 3/4" - 1/2"

T-12000 TURBO thermostatic valve

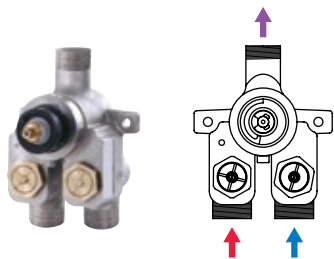
Rough **\$455**

- high flow thermostat cartridge
- universal inlets for 3/4" and 1/2" connections (built-in female threads for 1/2" connections and male threads for 3/4" connections)
- reversible service check valves with filters and improved stop mechanism
- italian made nickel plated solid brass rough and Vernet thermostatic cartridge
- **requires # 1206 shut-off valve or # 61934 independent diverter**

flow rate: 12 gpm at 45 psi

CARTRIDGE



ABCA11042

CHECK STOPS



ABS12094 / HOT



ABS12095 / COLD

EXTENSION

ABSPEXTHPC
(x1 extension kit for thermostat)

CHOICE OF TRIM SETS

(for optional handles, see p.252)



R3095 round trim set

- solid brass
- handle included

4^{1/4}" x 7^{7/8}" x 1/8"

Polished Chrome	\$150
Brushed Nickel	\$195
Electro Black	\$250
Brushed Gold	\$250
🔷 Custom Finish	\$300



SR3095 square / round trim set

- solid brass
- handle included

4^{1/4}" x 7^{7/8}" x 1/8"

Polished Chrome	\$195
Brushed Nickel	\$255
Electro Black	\$340
Brushed Gold	\$340
🔷 Custom Finish	\$390



S3095 square trim set

- solid brass
- handle included

4^{1/4}" x 7^{7/8}" x 1/8"

Polished Chrome	\$195
Brushed Nickel	\$255
Electro Black	\$340
Brushed Gold	\$340
🔷 Custom Finish	\$390

THERMOSTATIC VALVES 3/4" - 1/2"

T-12001 TURBO thermostatic valve with 1 shut-off valve

Rough **\$625**

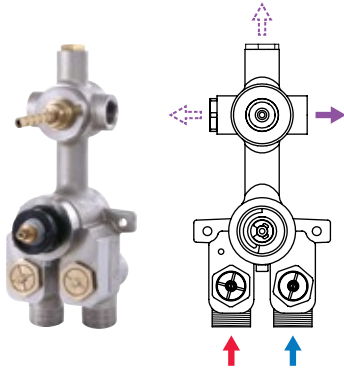

- high flow thermostat cartridge
- universal inlets for 3/4" and 1/2" connections (built-in female threads for 1/2" connections and male threads for 3/4" connections)
- reversible service check valves with filters and improved stop mechanism
- italian made nickel plated solid brass rough and Vernet thermostatic cartridge
- shut-off valve outlets: connections right, left or both sides simultaneously
- removable NPT plug at the top for an extra independent shut-off valve (# 1206) or diverter with stop (#61934) connection

flow rate: 12 gpm at 45 psi

CARTRIDGES

- ABCA12098 (x1) (shut-off / volume)
- ABCA11042 (thermostat)

CHECK STOPS

- ABSP12094 / HOT
- ABSP12095 / COLD

EXTENSIONS

- ABSPEXTHPC (x1 extension kit for thermostat)
- ABSPEXVOL (x1 extension kit for shut off)

CHOICE OF TRIM SETS

(for optional handles, see p.252)



R3195 round trim set

- solid brass plate
- handles included

4 1/4" x 11" x 1/8"

- Polished Chrome **\$260**
- Brushed Nickel **\$340**
- Electro Black **\$455**
- Brushed Gold **\$455**
- Custom Finish **\$520**



SR3195 square / round trim set

- solid brass plate
- handles included

4 1/4" x 11" x 1/8"

- Polished Chrome **\$340**
- Brushed Nickel **\$445**
- Electro Black **\$595**
- Brushed Gold **\$595**
- Custom Finish **\$680**



S3195 square trim set

- solid brass plate
- handles included

4 1/4" x 11" x 1/8"

- Polished Chrome **\$340**
- Brushed Nickel **\$445**
- Electro Black **\$595**
- Brushed Gold **\$595**
- Custom Finish **\$680**

THERMOSTATIC VALVES 3/4" - 1/2"

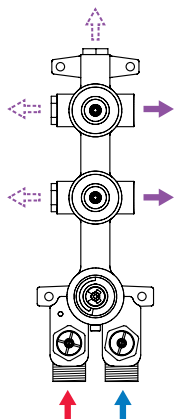



T-12002 TURBO thermostatic valve with 2 shut-off valve

Rough **\$795**



- high flow thermostat cartridge
- universal inlets for 3/4" and 1/2" connections (built-in female threads for 1/2" connections and male threads for 3/4" connections)
- reversible service check valves with filters and improved stop mechanism
- italian made nickel plated solid brass rough and Vernet thermostatic cartridge
- shut-off valve outlets: connections right, left or both sides simultaneously
- removable NPT plug at the top for an extra independent shut-off valve (# 1206) or diverter with stop (# 61934) connection

flow rate: 12 gpm at 45 psi



CARTRIDGES

-  ABCA12098 (x2) (shut-off / volume)
-  ABCA11042 (thermostat)

CHECK STOPS

-  ABSP12094 / HOT
-  ABSP12095 / COLD

EXTENSIONS

-  ABSPEXTHPC (x1 extension kit for thermostat)
-  ABSPEXVOL (x2 extension kit for shut off)

CHOICE OF TRIM SETS

(for optional handles, see p.252)



R3295 round trim set

- solid brass
- handles included

4 1/4" x 13 3/4" x 1/8"

- Polished Chrome **\$375**
- Brushed Nickel **\$490**
- Electro Black **\$655**
- Brushed Gold **\$655**
-  Custom Finish **\$750**



SR3295 square / round trim set

- solid brass
- handles included

4 1/4" x 13 3/4" x 1/8"

- Polished Chrome **\$490**
- Brushed Nickel **\$640**
- Electro Black **\$850**
- Brushed Gold **\$850**
-  Custom Finish **\$980**



S3295 square trim set

- solid brass
- handles included

4 1/4" x 13 3/4" x 1/8"

- Polished Chrome **\$490**
- Brushed Nickel **\$640**
- Electro Black **\$850**
- Brushed Gold **\$850**
-  Custom Finish **\$980**

THERMOSTATIC VALVES 3/4" - 1/2"

T-12003 TURBO thermostatic valve with 3 shut-off valve

Rough **\$965**

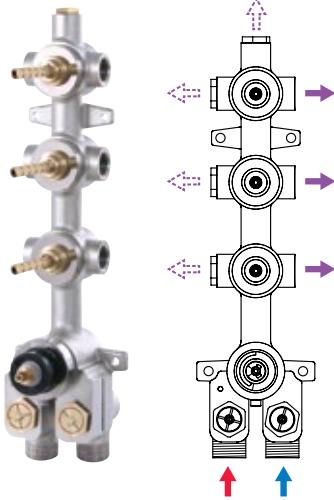

- high flow thermostat cartridge
- universal inlets for 3/4" and 1/2" connections (built-in female threads for 1/2" connections and male threads for 3/4" connections)
- reversible service check valves with filters and improved stop mechanism
- italian made nickel plated solid brass rough and Vernet thermostatic cartridge
- shut-off valve outlets: connections right, left or both sides simultaneously
- removable NPT plug at the top for an extra independent shut-off valve (#1206) or diverter with stop (#61934) connection

flow rate: 12 gpm at 45 psi

CARTRIDGES

 ABCA12098 (x3) (shut-off / volume)

 ABCA11042 (thermostat)

CHECK STOPS

 ABSP12094 / HOT

 ABSP12095 / COLD

EXTENSIONS

 ABSPEXTHPC (x1 extension kit for thermostat)

 ABSPEXVOL (x3 extension kit for shut off)

CHOICE OF TRIM SETS

(for optional handles, see p.252)



R3395 round trim set

- solid brass plate
- handles included

4 1/4" x 16 3/4" x 1/8"

Polished Chrome **\$495**

Brushed Nickel **\$645**

Electro Black **\$865**

Brushed Gold **\$865**

 Custom Finish **\$990**



SR3395 square / round trim set

- solid brass plate
- handles included

4 1/4" x 16 3/4" x 1/8"

Polished Chrome **\$645**

Brushed Nickel **\$840**

Electro Black **\$1130**

Brushed Gold **\$1130**

 Custom Finish **\$1290**



S3395 square trim set

- solid brass plate
- handles included

4 1/4" x 16 3/4" x 1/8"

Polished Chrome **\$645**

Brushed Nickel **\$840**

Electro Black **\$1130**

Brushed Gold **\$1130**

 Custom Finish **\$1290**

THERMOSTATIC VALVES 3/4" - 1/2"

T-12004 TURBO thermostatic valve with 4 shut-off valve

Rough **\$1135**

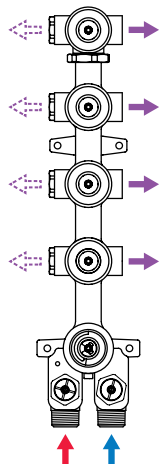

- high flow thermostat cartridge
- universal inlets for 3/4" and 1/2" connections (built-in female threads for 1/2" connections and male threads for 3/4" connections)
- reversible service check valves with filters and improved stop mechanism
- italian made nickel plated solid brass rough and Vernet thermostatic cartridge
- shut-off valve outlets: connections right, left or both sides simultaneously

flow rate: 12 gpm at 45 psi

CARTRIDGES

 ABCA12098 (x4) (shut-off / volume)

 ABCA11042 (thermostat)

CHECK STOPS

 ABSP12094 / HOT

 ABSP12095 / COLD

EXTENSIONS

 ABSPEXTHPC (x1 extension kit for thermostat)

 ABSPEXVOL (x4 extension kit for shut off)

CHOICE OF TRIM SETS

(for optional handles, see p.252)



R3495 round trim set

- solid brass
- handles included

4^{1/4}" x 19^{5/8}" x 1/8"

Polished Chrome	\$625
Brushed Nickel	\$815
Electro Black	\$1075
Brushed Gold	\$1075
 Custom Finish	\$1250



SR3495 square / round trim set

- solid brass
- handles included

4^{1/4}" x 19^{5/8}" x 1/8"

Polished Chrome	\$795
Brushed Nickel	\$1050
Electro Black	\$1385
Brushed Gold	\$1385
 Custom Finish	\$1590



S3495 square trim set

- solid brass
- handles included

4^{1/4}" x 19^{5/8}" x 1/8"

Polished Chrome	\$795
Brushed Nickel	\$1050
Electro Black	\$1385
Brushed Gold	\$1385
 Custom Finish	\$1590

THERMOSTATIC VALVES 3/4" - 1/2"

T-12005 TURBO thermostatic valve with 5 shut-off valve

Rough **\$1305**

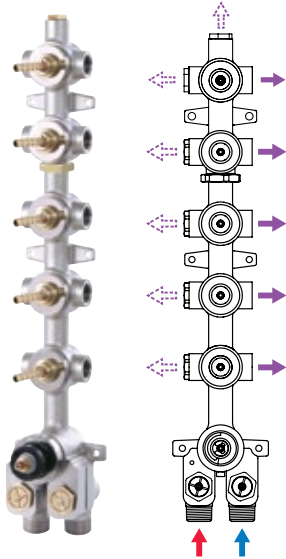

- high flow thermostat cartridge
- universal inlets for 3/4" and 1/2" connections (built-in female threads for 1/2" connections and male threads for 3/4" connections)
- reversible service check valves with filters and improved stop mechanism
- italian made nickel plated solid brass rough and Vernet thermostatic cartridge
- shut-off valve outlets: connections right, left or both sides simultaneously
- removable NPT plug at the top for an extra independent shut-off valve (#1206) or diverter with stop (#61934) connection

flow rate: 12 gpm at 45 psi

CARTRIDGES

 ABCA12098 (x5) (shut-off / volume)

 ABCA11042 (thermostat)

CHECK STOPS

 ABSP12094 / HOT

 ABSP12095 / COLD

EXTENSIONS

 ABSPEXTHPC (x1 extension kit for thermostat)

 ABSPEXVOL (x5 extension kit for shut off)

CHOICE OF TRIM SETS

(for optional handles, see p.252)

SRH3595L square / round trim set



thermostat to the left

- thermostat to the left
- solid brass plate
- handles included

21" x 4^{1/4}" x 1/8"

Polished Chrome **\$775**
 Brushed Nickel **\$1025**
 Electro Black **\$1350**
 Brushed Gold **\$1350**
 Custom Finish **\$1550**

SRH3595R square / round trim set



thermostat to the right

- thermostat to the right
- solid brass plate
- handles included

21" x 4^{1/4}" x 1/8"

Polished Chrome **\$775**
 Brushed Nickel **\$1025**
 Electro Black **\$1350**
 Brushed Gold **\$1350**
 Custom Finish **\$1550**

SR3595 round trim set



- solid brass plate
- handles included

4^{1/4}" x 21" x 1/8"

Polished Chrome **\$775**
 Brushed Nickel **\$1025**
 Electro Black **\$1350**
 Brushed Gold **\$1350**
 Custom Finish **\$1550**

2 & 3 WAY DIVERTER

61934 2 & 3 way independent diverter

Rough **\$195**



- solid brass
- single diverter body for a 2- or 3-way diverter (shared and non-shared)
- accomodates any wall thickness
- test cap

flow rate: 12 gpm at 45 psi

CARTRIDGES (diverter with stop)

- 2-way, shared ABCATH200
- 2-way, non-shared ABCATH2LD
- 2-way, shared ABCATH300
- 2-way, non-shared ABCATH3LD

DIVERTER WITH STOP

COMBINE WITH TURBO THERMOSTATIC VALVES

HOW IT WORKS

Combine with thermostatic valve #T12000 for a minimalist look or with any other valves from our TURBO thermostatic collection to express your creativity.

2-WAY DIVERTER (WITH STOP)

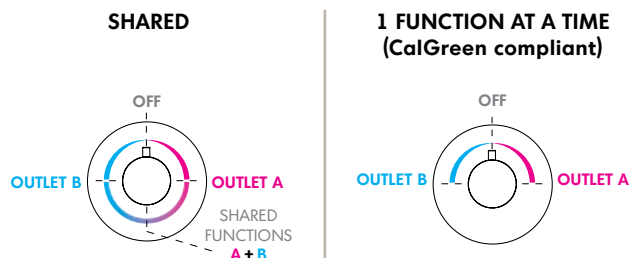

3-WAY DIVERTER (WITH STOP)

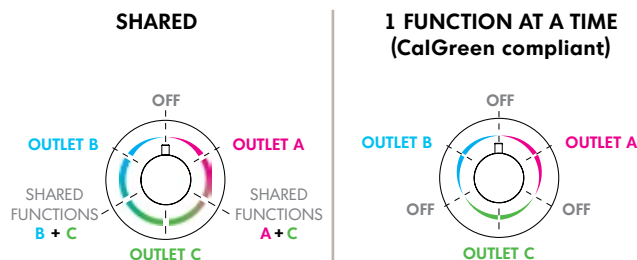

CHOICE OF TRIM SETS

(optional handles not available)



ø 2^{3/4}" x 1/8"



2^{3/4}" x 2^{3/4}" x 1/8"



Polished Chrome	\$245	Polished Chrome	\$275
Brushed Nickel	\$295	Brushed Nickel	\$325
Electro Black	\$355	Electro Black	\$395
Brushed Gold	\$355	Brushed Gold	\$395
Custom Finish	\$490	Custom Finish	\$550

2-WAY, SHARED FUNCTIONS



2-WAY, NON-SHARED



3-WAY, SHARED FUNCTIONS



3-WAY, NON-SHARED



SHUT-OFF VALVE



1206 1/2" shut-off valve

Rough **\$165**

- solid brass
- 1/2" NPT female connections (inlet / outlet)
- adjustable splines
- adjustable back plate

flow rate: depends on supply valve capacity

CARTRIDGE (shut-off / volume)



EXTENSION

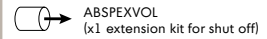

CHOICE OF TRIM SETS

(for optional handles, see p.252)



R0695 round trim set

- solid brass plate
- handle included

∅ 3^{1/4}" x 1/8"

Polished Chrome	\$130
Brushed Nickel	\$165
Electro Black	\$225
Brushed Gold	\$225
🔗 Custom Finish	\$260



SR0695 square / round trim set

- solid brass plate
- handle included

3^{1/4}" x 4^{1/4}" x 1/8"

Polished Chrome	\$160
Brushed Nickel	\$205
Electro Black	\$280
Brushed Gold	\$280
🔗 Custom Finish	\$320



S0695 square trim set

- solid brass plate
- handle included

3^{1/4}" x 4^{1/4}" x 1/8"

Polished Chrome	\$160
Brushed Nickel	\$205
Electro Black	\$280
Brushed Gold	\$280
🔗 Custom Finish	\$320

THERMO VALVE UNIPLEX 3/4" - 1/2"

A UNIVERSAL VALVE OFFERING MULTIPLE CONFIGURATION SOLUTIONS FOR A 2- OR 3-FUNCTION SHOWER, INCLUDING A CALGREEN COMPLIANT OPTION.

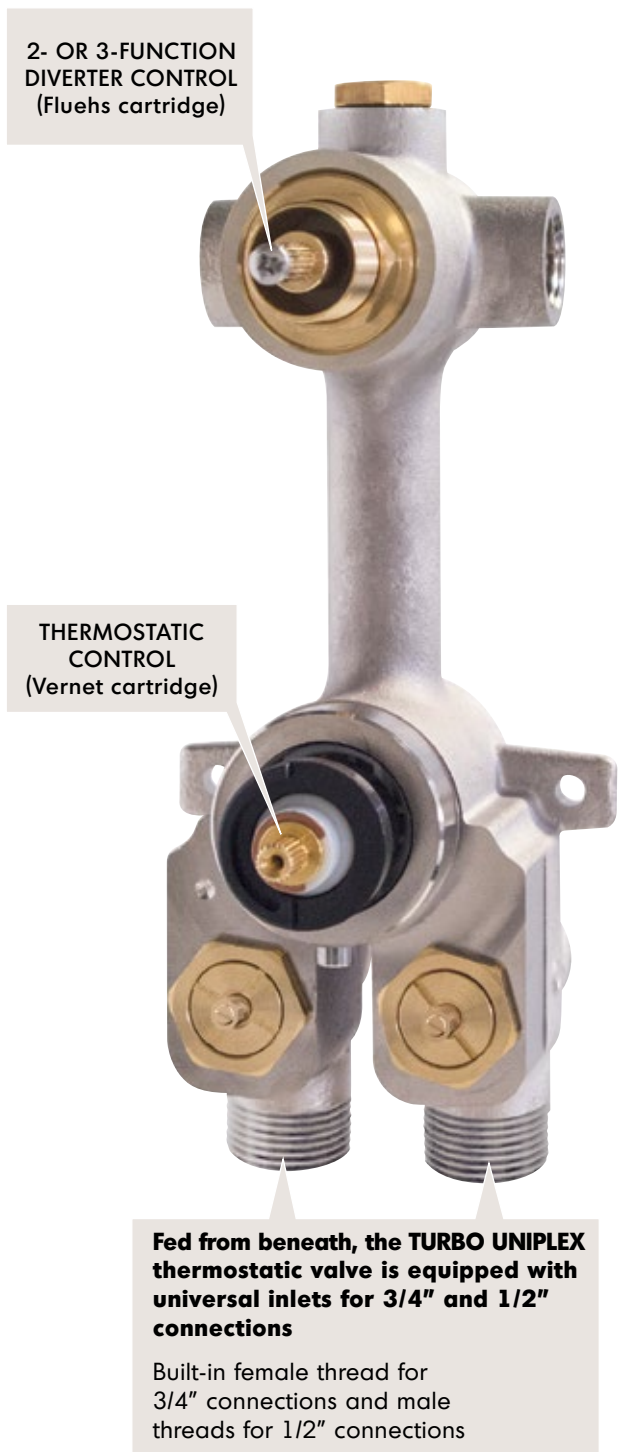
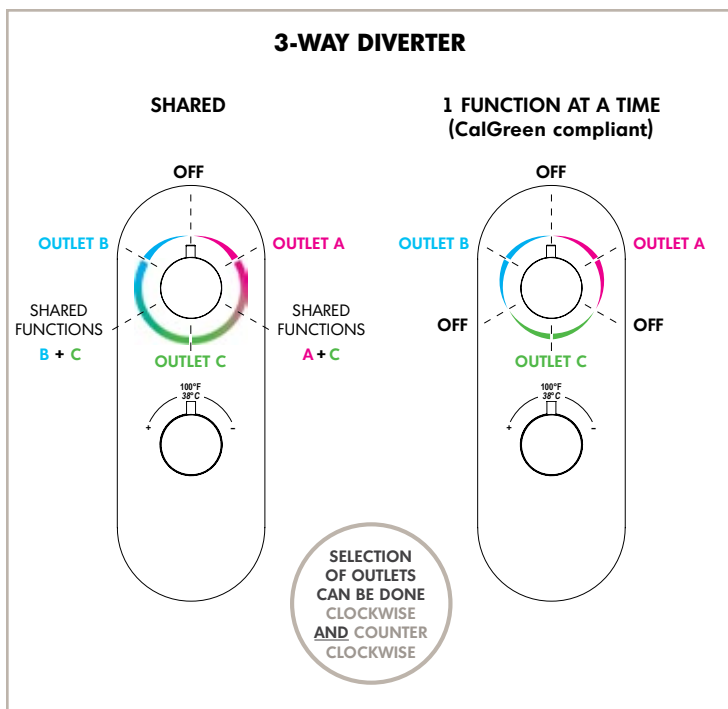
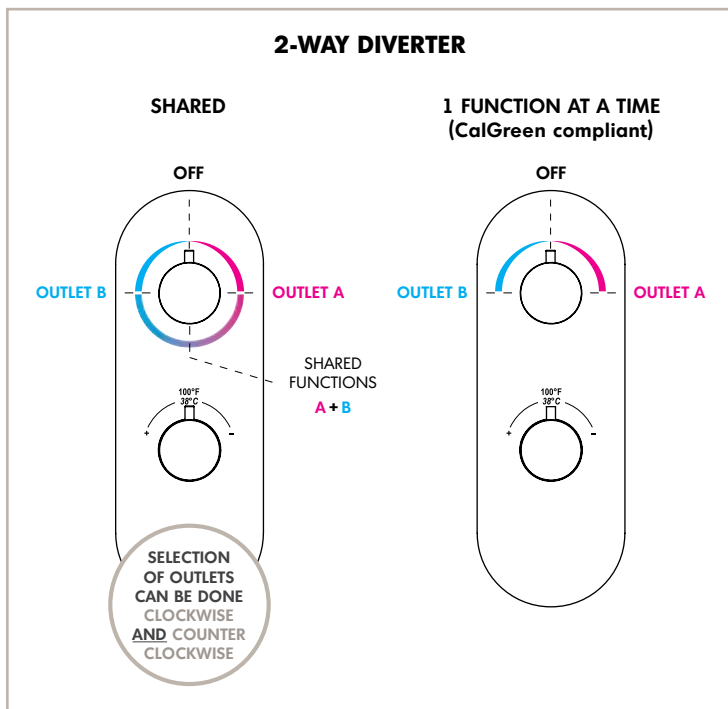

Fed from beneath, the TURBO UNIPLEX thermostatic valve is equipped with universal inlets for 3/4" and 1/2" connections

Built-in female thread for 3/4" connections and male threads for 1/2" connections

THERMO VALVE UNIPLEX 3/4" - 1/2"

T-12123 TURBO thermostatic valve with diverter UNIPLEX 2/3 way

Rough \$495

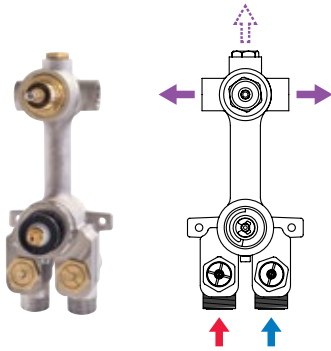

- high flow thermostat cartridge
- universal inlets for 3/4" and 1/2" connections (built-in female threads for 1/2" connections and male threads for 3/4" connections)
- reversible service check valves with filters and improved stop mechanism
- italian made nickel plated solid brass rough, Vernet thermostatic cartridge and Fluehs diverter cartridge
- shut-off valve outlets: connections right, left or both sides simultaneously
- removable NPT plug at the top for an extra independent shut-off valve (#1206) or diverter with stop (#61934) connection

flow rate: 12 gpm at 45 psi

CHOICE OF STANDARD TRIM SETS (for optional handles, see p.252)



4 1/4" x 12" x 1/8"

Polished Chrome	\$350
Brushed Nickel	\$455
Electro Black	\$615
Brushed Gold	\$615
Custom Finish	\$700



4 1/4" x 12" x 1/8"

Polished Chrome	\$455
Brushed Nickel	\$590
Electro Black	\$795
Brushed Gold	\$795
Custom Finish	\$910

CARTRIDGES

- 2-way, shared ABCATH200 (diverter)
- 2-way, non-shared ABCATH2LD (diverter)
- 2-way, shared ABCATH300 (diverter)
- 2-way, non-shared ABCATH3LD (diverter)
- ABCA11042 (thermostat)

CHECK STOPS

- ABSP12094 / HOT
- ABSP12095 / COLD

EXTENSIONS

- ABSPEXTHPC (x1 extension kit for thermostat)
- ABSP123EXD (x1 extension kit for diverter)

2-WAY, SHARED FUNCTIONS



R8295



S8295



SR8295

2-WAY, NON-SHARED



R9295



S9295



SR9295

3-WAY, SHARED FUNCTIONS



R8395



S8395



SR8395

3-WAY, NON-SHARED



R9395



S9395



SR9395

OPTIONAL HANDLES THERMO TRIM SETS

CUSTOMIZE YOUR TRIM SET

UNIQUE PRICE: Polished Chrome **\$95** Brushed Nickel **\$125** Electro Black **\$165** Brushed Gold **\$165** Custom Finish **\$190** ↗

FOR THERMOSTATIC CONTROL + SHUT-OFF VALVE

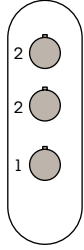

1- thermostatic control
2- shut-off valve

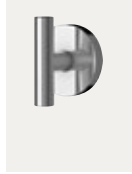

**32095
LOVEME**



**61095
VOLARE**



**53095
OTTO**

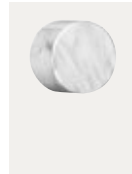

**CL95BC
MARMO
CARRARA**
*unique price
\$245

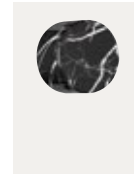

**CL95NM
MARMO
MARQUINA**
*unique price
\$245

FOR THERMOSTATIC CONTROL ONLY

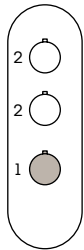

1- thermostatic control
2- shut-off valve



**19495
CHICANE**



**84473
PARK**

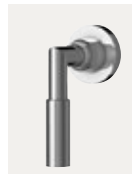

**78473
GEO**

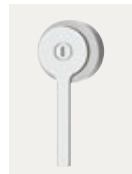

**51595
TIME**

PRESSURE BALANCE



40255 1/2" pressure balance valve for shower

- solid brass
- 1/2" NPT male / sweat connection

flow rate: 4.5 gpm at 45 psi

Polished Chrome	\$235
Brushed Nickel	\$265
Electro Black	\$415
Brushed Gold	\$415

Custom Finish **\$470**

CARTRIDGE (pressure balance)



EXTENSION

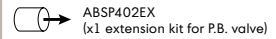

CHOICE OF TRIM SETS (for optional handles, see p.255)



R4095 ø 8" x 1/8"

Polished Chrome	\$135
Brushed Nickel	\$175
Electro Black	\$235
Brushed Gold	\$235
Custom Finish	\$270



S4095 6 1/2" x 8 1/4" x 1/8"

Polished Chrome	\$165
Brushed Nickel	\$215
Electro Black	\$285
Brushed Gold	\$285
Custom Finish	\$330



42355 1/2" pressure balance valve for tub / shower

- solid brass
- 1/2" NPT male / sweat connection

flow rate: 4.5 gpm at 45 psi

Polished Chrome	\$425
Brushed Nickel	\$485
Electro Black	\$745
Brushed Gold	\$745

Custom Finish **\$850**

CARTRIDGE (pressure balance)



EXTENSION

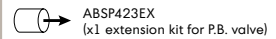

CHOICE OF TRIM SETS (for optional handles, see p.255)



R4295 ø 8" x 1/8"

Polished Chrome	\$165
Brushed Nickel	\$215
Electro Black	\$290
Brushed Gold	\$290
Custom Finish	\$330



S4295 6 1/2" x 8 1/4" x 1/8"

Polished Chrome	\$195
Brushed Nickel	\$250
Electro Black	\$345
Brushed Gold	\$345
Custom Finish	\$390

2 & 3 WAY DIVERTER

61934 2 & 3 way independent diverter

Rough **\$195**



- solid brass
- single diverter body for a 2- or 3-way diverter (shared and non-shared)
- accomodates any wall thickness
- test cap

flow rate: 12 gpm at 45 psi

CARTRIDGES (diverter without stop)

- 2-way, shared ABCAPB200
- 2-way, non-shared ABCAPB2LD
- 2-way, shared ABCAPB300
- 2-way, non-shared ABCAPB3LD

DIVERTER WITHOUT STOP

COMBINE WITH PRESSURE BALANCE VALVE #40255

HOW IT WORKS

2-WAY DIVERTER (WITHOUT STOP)

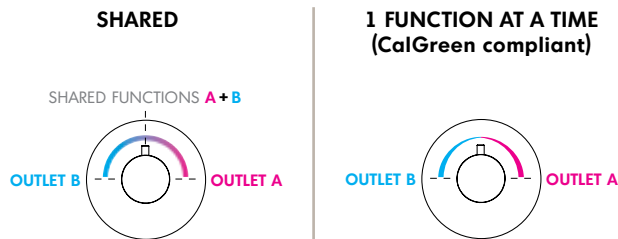

3-WAY DIVERTER (WITHOUT STOP)

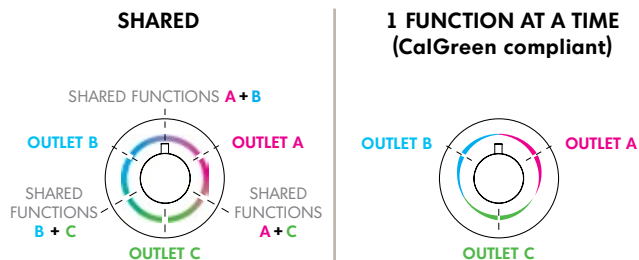

CHOICE OF TRIM SETS

(optional handles not available)



ø 2^{3/4}" x 1/8"



2^{3/4}" x 2^{3/4}" x 1/8"



Polished Chrome	\$245	Polished Chrome	\$275
Brushed Nickel	\$295	Brushed Nickel	\$325
Electro Black	\$355	Electro Black	\$395
Brushed Gold	\$355	Brushed Gold	\$395
Custom Finish	\$490	Custom Finish	\$550

2-WAY, SHARED FUNCTIONS



2-WAY, NON-SHARED



3-WAY, SHARED FUNCTIONS



3-WAY, NON-SHARED



OPTIONAL HANDLES P.B. TRIM SETS

CUSTOMIZE YOUR TRIM SET

UNIQUE PRICE: Polished Chrome **\$65** Brushed Nickel **\$85** Electro Black **\$115** Brushed Gold **\$115** Custom Finish **\$130** ↗

PRESSURE BALANCE HANDLES FOR VALVES 40255 AND 42355

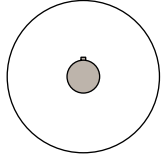

78373
GEO



37373
BLADE



17173
METRO

ROUND RAINHEADS



708 8" round rainhead

- solid brass construction
- silicone spray nozzles for easy cleaning
- water-saving air induction system
- 1/2" NPT female connection

flow rate: 2.5 gpm

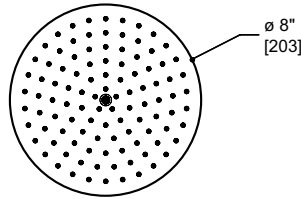
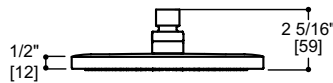

Polished Chrome	\$245
Brushed Nickel	\$315



710 10" round rainhead

- solid brass construction
- silicone spray nozzles for easy cleaning
- water-saving air induction system
- 1/2" NPT female connection

flow rate: 2.5 gpm

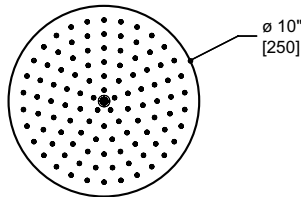
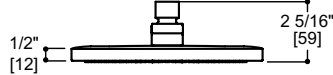

Polished Chrome	\$345
Brushed Nickel	\$445
Electro Black	\$445
Brushed Gold	\$485
Custom Finish	\$690



712 12" round rainhead

- solid brass construction
- silicone spray nozzles for easy cleaning
- water-saving air induction system
- 1/2" NPT female connection

flow rate: 2.5 gpm

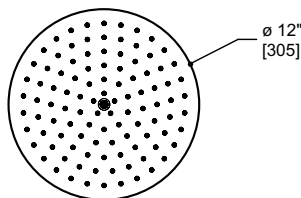

Polished Chrome	\$445
Brushed Nickel	\$575

SHOWER ARMS



M8102 18" round shower arm & flange

- solid brass construction
- 1/2" NPT male connection

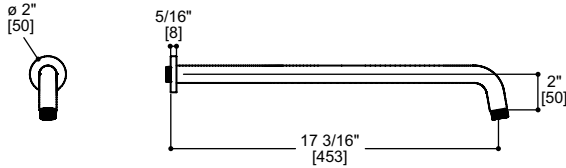

Polished Chrome	\$70
Brushed Nickel	\$90
Electro Black	\$90
Brushed Gold	\$120
Custom Finish	\$140



M8103 16" round shower arm & flange

- solid brass construction
- 1/2" NPT male connection

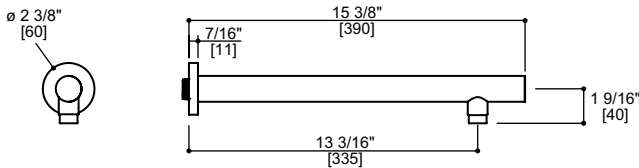

Polished Chrome	\$90
Brushed Nickel	\$110



M8401 4" round ceiling drop & flange

- solid brass construction
- 1/2" NPT male connection

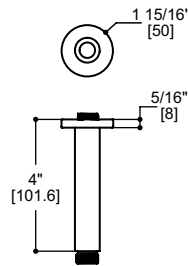

Polished Chrome	\$65
Brushed Nickel	\$80
Electro Black	\$80
Brushed Gold	\$115
Custom Finish	\$130



M8301 6" round ceiling drop & flange

- solid brass construction
- 1/2" NPT male connection

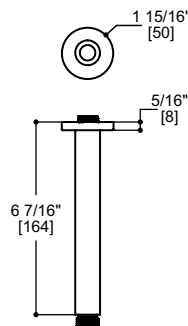

Polished Chrome	\$75
Brushed Nickel	\$95
Electro Black	\$95
Brushed Gold	\$130
Custom Finish	\$150

SQUARE RAINHEADS

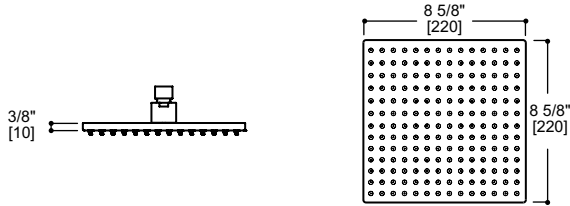
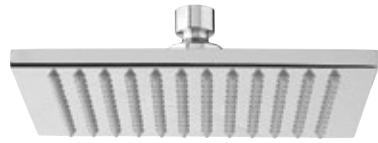

808 8" square rainhead

- solid brass construction
- 1/2" NPT female connection

flow rate: 2.5 gpm

Polished Chrome	\$399
Brushed Nickel	\$519

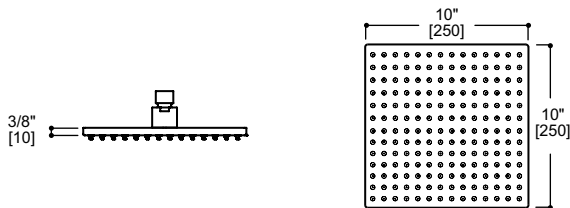

810 10" square rainhead

- solid brass construction
- 1/2" NPT female connection

flow rate: 2.5 gpm

Polished Chrome	\$489
Brushed Nickel	\$635
Electro Black	\$855
Brushed Gold	\$855
 Custom Finish	\$978

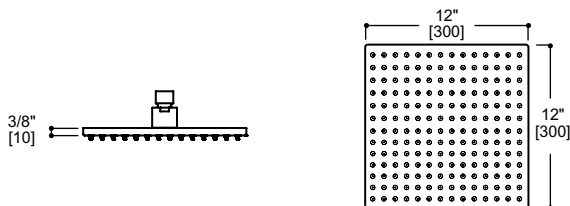

811 12" square rainhead

- solid brass construction
- 1/2" NPT female connection

flow rate: 2.5 gpm

Polished Chrome	\$579
Brushed Nickel	\$755

SHOWER ARMS

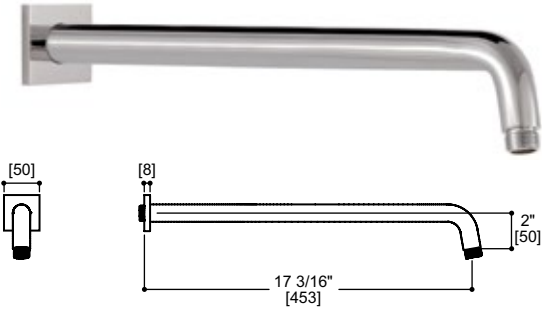

M8206 18" round shower arm & square flange

- solid brass construction
- 1/2" NPT male connection

Polished Chrome	\$95
Brushed Nickel	\$125
Electro Black	\$125
Brushed Gold	\$185
Custom Finish	\$190

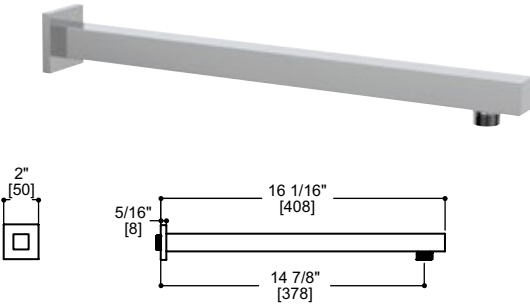

M8203 16" square shower arm & flange

- solid brass construction
- 1/2" NPT male connection

Polished Chrome	\$115
Brushed Nickel	\$145

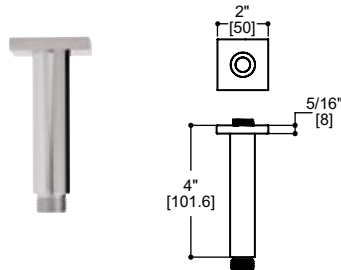

M8402 4" round ceiling drop & square flange

- solid brass construction
- 1/2" NPT male connection

Polished Chrome	\$75
Brushed Nickel	\$95
Electro Black	\$95
Brushed Gold	\$135
Custom Finish	\$150

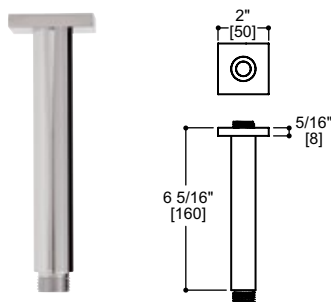

M8302 6" round ceiling drop & square flange

- solid brass construction
- 1/2" NPT male connection

Polished Chrome	\$85
Brushed Nickel	\$110
Electro Black	\$110
Brushed Gold	\$145
Custom Finish	\$170

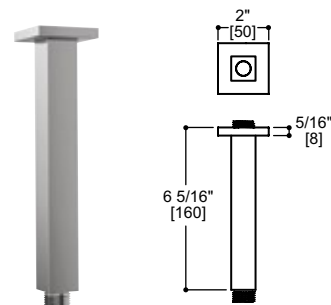

M8303 6" square ceiling drop & flange

- solid brass construction
- 1/2" NPT male connection

Polished Chrome	\$115
Brushed Nickel	\$155

CLASSIC RAINHEADS

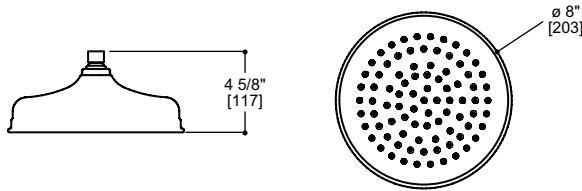

2508 8" bell rainhead

- solid brass construction
- 1/2" NPT female connection

flow rate: 2.5 gpm

Polished Chrome	\$325
Brushed Nickel	\$425

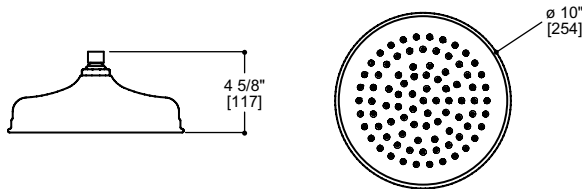

2510 10" bell rainhead

- solid brass construction
- 1/2" NPT female connection

flow rate: 2.5 gpm

Polished Chrome	\$425
Brushed Nickel	\$555
Electro Black	\$745
Brushed Gold	\$745
Custom Finish	\$850

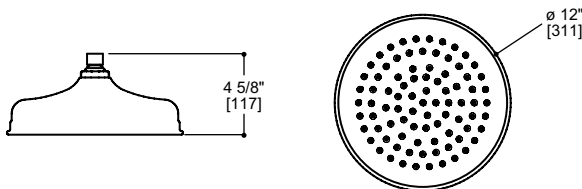

2512 12" bell rainhead

- solid brass construction
- 1/2" NPT female connection

flow rate: 2.5 gpm

Polished Chrome	\$525
Brushed Nickel	\$685

SHOWER ARMS



M8102 18" round shower arm & flange

- solid brass construction
- 1/2" NPT male connection

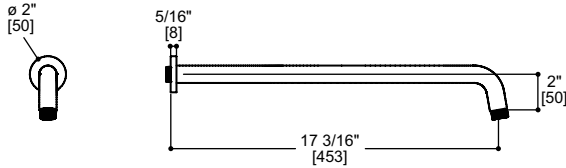

Polished Chrome	\$70
Brushed Nickel	\$90
Electro Black	\$90
Brushed Gold	\$120
Custom Finish	\$140



M8103 16" round shower arm & flange

- solid brass construction
- 1/2" NPT male connection

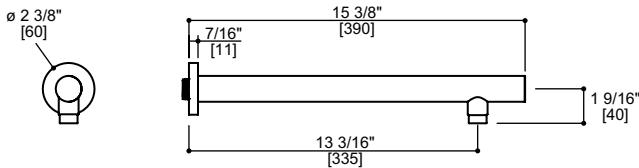

Polished Chrome	\$90
Brushed Nickel	\$110



M8401 4" round ceiling drop & flange

- solid brass construction
- 1/2" NPT male connection

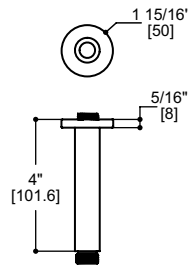

Polished Chrome	\$65
Brushed Nickel	\$80
Electro Black	\$80
Brushed Gold	\$115
Custom Finish	\$130



M8301 6" round ceiling drop & flange

- solid brass construction
- 1/2" NPT male connection

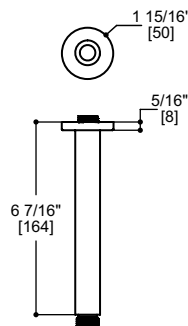

Polished Chrome	\$75
Brushed Nickel	\$95
Electro Black	\$95
Brushed Gold	\$130
Custom Finish	\$150

SHOWERHEAD



567 3" round showerhead with arm

- 3 functions: rain, massage, mist
- 6" round arm with flange
- 1/2" NPT female connection

flow rate: 2.5 gpm

Polished Chrome	\$135
Brushed Nickel	\$170
Electro Black	\$235
Brushed Gold	\$235
Custom Finish	\$270

3 FUNCTIONS



465 3" round showerhead

- 3 functions: rain, massage, mist
- 1/2" NPT female connection

flow rate: 2.5 gpm

Polished Chrome	\$85
Brushed Nickel	\$105
Electro Black	\$145
Brushed Gold	\$145
Custom Finish	\$170

3 FUNCTIONS



M8101 6" round shower arm & flange

- solid brass construction
- 1/2" NPT male connection

Polished Chrome	\$50
Brushed Nickel	\$65
Electro Black	\$85
Brushed Gold	\$85
Custom Finish	\$100

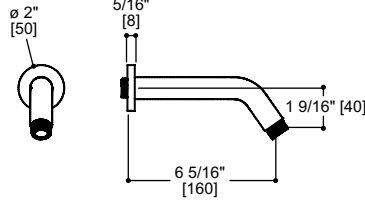

M8201 6" round shower arm & square flange

- solid brass construction
- 1/2" NPT male connection

Polished Chrome	\$50
Brushed Nickel	\$65
Electro Black	\$85
Brushed Gold	\$85
Custom Finish	\$100

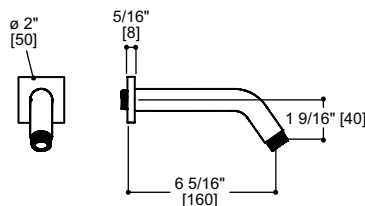

WALLMOUNT RAINHEAD



2872 AQUASHEET wallmount dual function rainhead

- 2 functions: rain, cascading chute
- concealed water-saving air induction system
- 10" rainhead
- 7" wide chute
- 2 port valve required
- 1/2" NPT female connection

projection: 20^{1/2}"

flow rate: 2.5 gpm



Now available in Electro Black

Polished Chrome	\$895
Brushed Nickel	\$1195
Electro Black	\$1195

2 FUNCTIONS

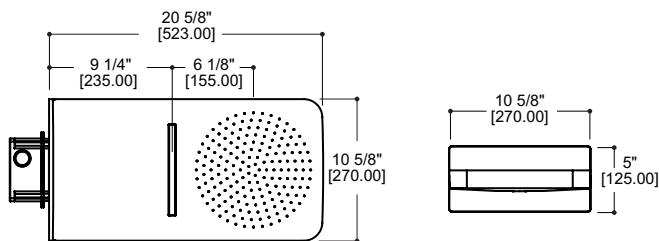
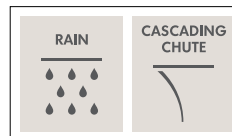

SOFFIT RAINHEADS

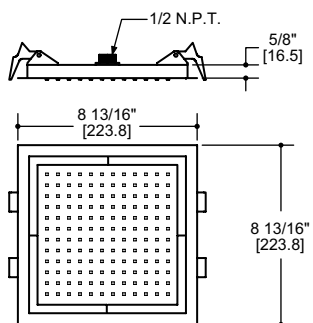
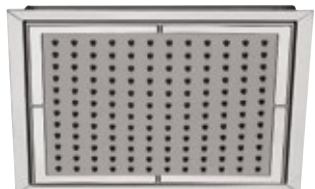

801 8" x 8" recessed rainhead

- stainless steel construction
- pre-assembled
- easy clip installation
- 1/2" NPT male connection

flow rate: 2.5 gpm

Polished Chrome

\$625

Can also be used
as a large wallmount
body jet

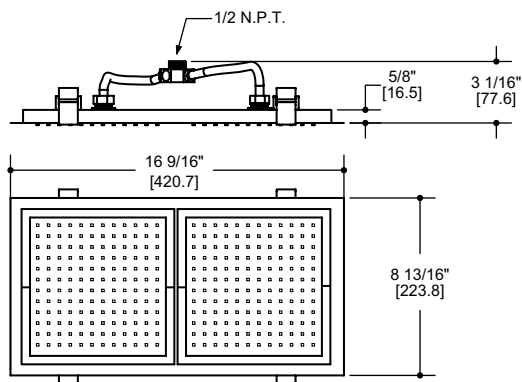
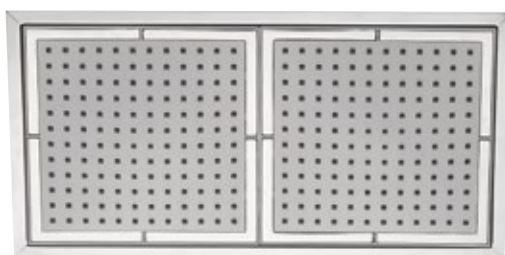

802 8" x 16" recessed rainhead

- stainless steel construction
- pre-assembled
- easy clip installation
- 1/2" NPT male connection

flow rate: 2.5 gpm

Polished Chrome

\$1250

Can also be used
as a neck chute

SOFFIT RAINHEADS

803 8" x 24" recessed rainhead

- stainless steel construction
- pre-assembled
- easy clip installation
- 1/2" NPT male connection

flow rate: 2.5 gpm

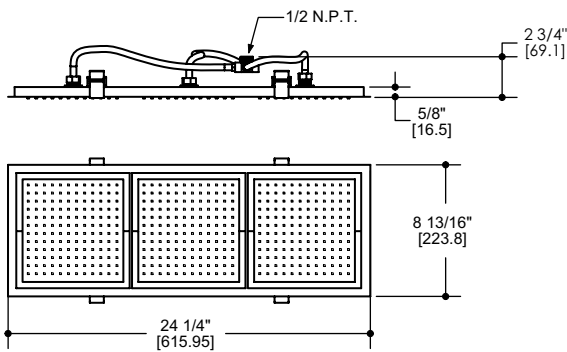
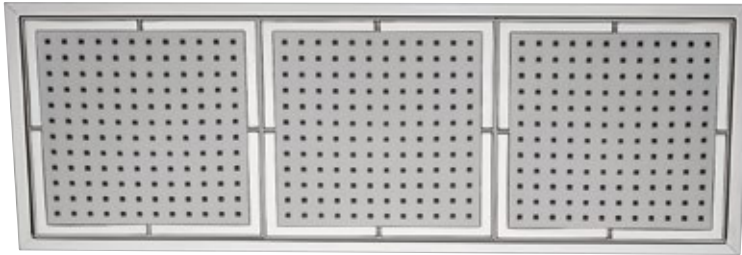

Polished Chrome

\$1875

815 16" x 16" recessed rainhead

- stainless steel construction
- pre-assembled
- easy clip installation
- 1/2" NPT male connection

flow rate: 2.5 gpm

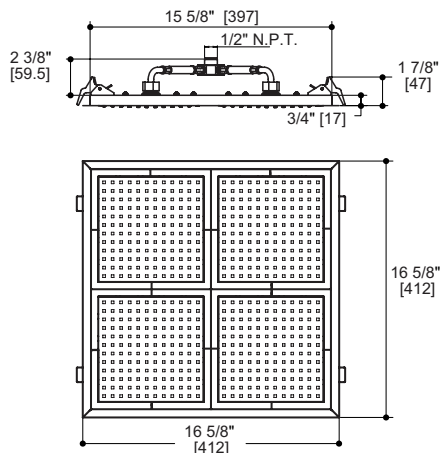
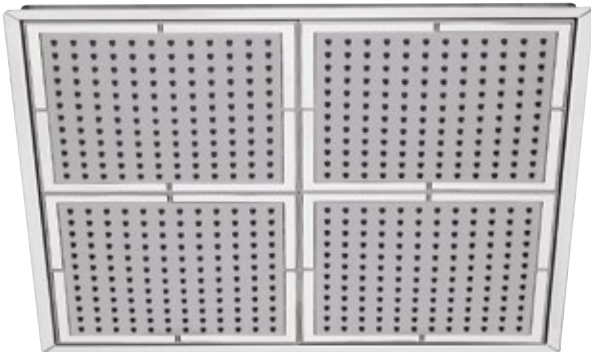

Polished Chrome

\$2500

SOFFIT RAINHEADS

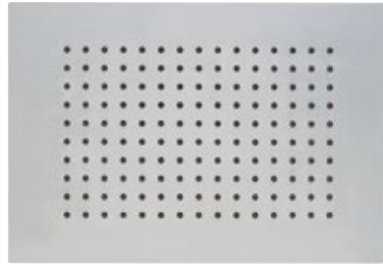

807 11¹/₄" x 7⁷/₈" recessed rainhead

- stainless steel construction
- easy clip installation
- 1/2" NPT male connection

flow rate: 2.5 gpm

Polished Stainless Steel	\$1095
Brushed Stainless Steel	\$1095

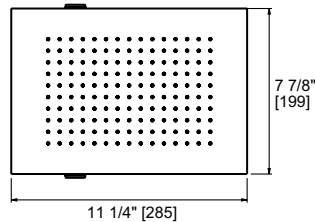
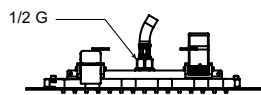

Can also be used
as a large wallmount
body jet

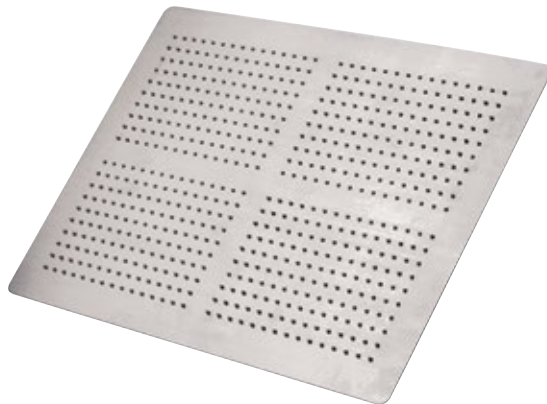

820 14" x 19⁵/₈" recessed rainhead

- stainless steel construction
- easy clip installation
- 1/2" NPT male connection

flow rate: 2.5 gpm

Polished Stainless Steel	\$2995
Brushed Stainless Steel	\$2995

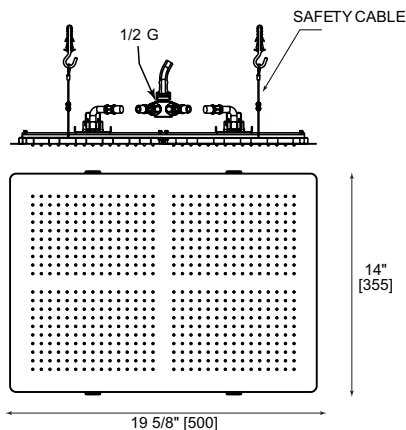



3-function square handshower #85154

SHOWER RAILS



12685 complete shower rail

- round rail with adjustable sliding hook
- push button 3 functions: rain, mist, jet
- 5' to 6' expandable braided hose

height: 31^{1/2}"
flow rate: 2.5 gpm

3 FUNCTIONS

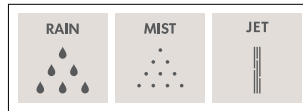

Polished Chrome	\$250
Brushed Nickel	\$295
Electro Black	\$325



12784 complete shower rail

- square rail with adjustable sliding hook
- push button 3 functions: rain, mist, jet
- 5' to 6' expandable braided hose

height: 31^{1/2}"
flow rate: 2.5 gpm

3 FUNCTIONS

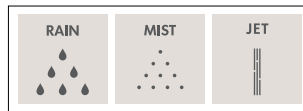

Polished Chrome	\$270
Brushed Nickel	\$335
Electro Black	\$370

SHOWER RAILS



12695 complete shower rail

- round rail with adjustable sliding hook
- 1 function: rain
- 5' to 6' expandable braided hose

height: 31¹/₂"
flow rate: 2.5 gpm

1 FUNCTION

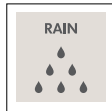

Polished Chrome **\$265**
Brushed Nickel **\$345**



12794 complete shower rail

- square rail with adjustable sliding hook
- 1 function: rain
- 5' to 6' expandable braided hose

height: 31¹/₂"
flow rate: 2.5 gpm

1 FUNCTION

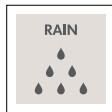

Polished Chrome **\$315**
Brushed Nickel **\$405**

SHOWER RAILS



12716 complete shower rail

- square rail with adjustable sliding hook
- 5 functions: rain, rain / massage, massage, massage / jet, jet
- 5' to 6' expandable braided hose

height: 31^{1/2}"

flow rate: 2.5 gpm

5 FUNCTIONS



Polished Chrome **\$335**

Brushed Nickel **\$435**

Electro Black **\$550**

Brushed Gold **\$550**

Custom Finish **\$670**



12762 complete shower rail

- round rail with adjustable sliding hook
- 3 function handshower: rain, rain/jet, jet
- 5' to 6' expandable braided hose

height: 31^{1/2}"

flow rate: 2.5 gpm

3 FUNCTIONS

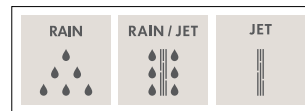

Polished Chrome **\$335**

Brushed Nickel **\$435**

Electro Black **\$550**

Brushed Gold **\$550**

Custom Finish **\$670**

WATERWAYS



1409 adjustable round waterway

- thermo insulation body
- 5/8" trim adjustment to elbow installation
- 1/2" NPT female connection

Polished Chrome	\$40
Brushed Nickel	\$50
Electro Black	\$50



1408 adjustable square waterway

- thermo insulation body
- 5/8" trim adjustment to elbow installation
- 1/2" NPT female connection

Polished Chrome	\$50
Brushed Nickel	\$65
Electro Black	\$65



1404 round waterway

- solid brass construction
- 1/2" NPT female connection

Polished Chrome	\$65
Brushed Nickel	\$85
Electro Black	\$115
Brushed Gold	\$115
🔼 Custom Finish	\$130



1401 square waterway

- solid brass construction
- 1/2" NPT female connection

Polished Chrome	\$75
Brushed Nickel	\$100
Electro Black	\$135
Brushed Gold	\$135
🔼 Custom Finish	\$150

WATERWAYS



1436 round waterway with stop valve

- solid brass construction
- 1/2" NPT female connection

Polished Chrome **\$195**
Brushed Nickel **\$255**



1438 square waterway with stop valve

- solid brass construction
- 1/2" NPT female connection

Polished Chrome **\$225**
Brushed Nickel **\$295**



1417 round waterway with hook

- solid brass construction
- 1/2" NPT female connection

Polished Chrome **\$95**
Brushed Nickel **\$125**
Electro Black **\$165**
Brushed Gold **\$165**
Custom Finish **\$190**



1421 square waterway with hook

- solid brass construction
- 1/2" NPT female connection

Polished Chrome **\$125**
Brushed Nickel **\$165**
Electro Black **\$215**
Brushed Gold **\$215**
Custom Finish **\$250**



1425 round hook

- solid brass construction

Polished Chrome **\$135**
Brushed Nickel **\$170**

HANDSHOWER SETS



N3645 round handshower set with braided hose

- single function handshower
- solid brass waterway with hook
- 5' to 6' expandable braided hose
- 1/2" NPT female connection

flow rate: 2.5 gpm

1 FUNCTION

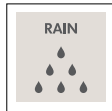

Polished Chrome	\$275
Brushed Nickel	\$355
Electro Black	\$450
Brushed Gold	\$450
 Custom Finish	\$550



N3745 square handshower set with braided hose

- single function handshower
- solid brass waterway with hook
- 5' to 6' expandable braided hose
- 1/2" NPT female connection

flow rate: 2.5 gpm

1 FUNCTION

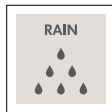

Polished Chrome	\$325
Brushed Nickel	\$425
Electro Black	\$550
Brushed Gold	\$550
 Custom Finish	\$650

HANDSHOWERS



85265 round handshower

- push button 3 functions: rain, mist, jet

flow rate: 2.5 gpm

3 FUNCTIONS

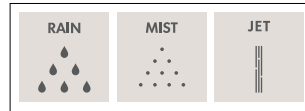

- Polished Chrome **\$100**
- Brushed Nickel **\$125**
- Electro Black **\$135**



85279 round handshower

- 3 functions: rain, massage, jet

flow rate: 2.5 gpm

3 FUNCTIONS



- Polished Chrome **\$105**
- Brushed Nickel **\$135**



85162 round handshower

- 5 functions: rain, rain / massage, massage, massage / jet, jet

flow rate: 2.5 gpm

5 FUNCTIONS



- Polished Chrome **\$95**
- Brushed Nickel **\$125**
- Electro Black **\$165**
- Brushed Gold **\$165**
- Custom Finish **\$190**



85164 round handshower

- 3 functions: rain, rain/jet, jet

flow rate: 2.5 gpm

3 FUNCTIONS

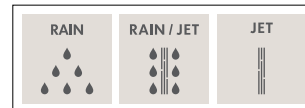

- Polished Chrome **\$75**
- Brushed Nickel **\$95**
- Custom Finish **\$150**

HANDSHOWERS



85154 round handshower

- push button 3 functions: rain, mist, jet

flow rate: 2.5 gpm

3 FUNCTIONS

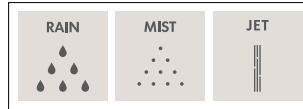

Polished Chrome **\$110**

Brushed Nickel **\$135**

Electro Black **\$145**



85275 square handshower

- 3 functions: rain, rain / massage, massage

flow rate: 2.5 gpm

3 FUNCTIONS

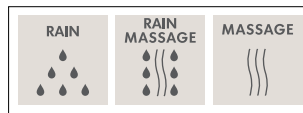

Polished Chrome **\$90**

Brushed Nickel **\$115**

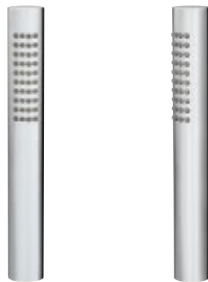

85285 round handshower

- 1 function: rain

flow rate: 2.5 gpm

1 FUNCTION

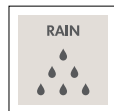

Polished Chrome **\$135**

Brushed Nickel **\$175**

Custom Finish **\$270**



85174 square handshower

- 1 function: rain

flow rate: 2.5 gpm

1 FUNCTION

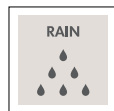

Polished Chrome **\$175**

Brushed Nickel **\$225**

Custom Finish **\$350**

RAILS



- 12686 round rail**
 • adjustable sliding hook
 height: 31^{1/2}"

Polished Chrome	\$140
Brushed Nickel	\$175
Electro Black	\$195



- 12696 square rail**
 • adjustable sliding hook
 height: 31^{1/2}"

Polished Chrome	\$160
Brushed Nickel	\$200
Electro Black	\$220



- 12753 square rail**
 • adjustable sliding hook
 height: 31^{1/2}"

Polished Chrome	\$185
Brushed Nickel	\$240
Electro Black	\$325
Brushed Gold	\$325
 Custom Finish	\$370



- 12763 classic rail**
 • adjustable sliding hook
 height: 31^{1/2}"

Polished Chrome	\$195
Brushed Nickel	\$255
Electro Black	\$340
Brushed Gold	\$340
 Custom Finish	\$390

HOSES



135 5' to 6' triple interlock expandable braided hose

- triple interlock expandable braided hose with swivel 1/2" connections

Polished Chrome **\$70**

Brushed Nickel **\$95**

✦ Custom Finish **\$140**



126 6' to 7' triple interlock expandable braided hose

- triple interlock expandable braided hose with swivel 1/2" connections

Polished Chrome **\$75**

Brushed Nickel **\$100**



136 5' reinforced pvc hose

- 1/2" connection

Polished Chrome **\$75**

Brushed Nickel **\$100**



172 6' reinforced pvc hose

- 1/2" connection

Polished Chrome **\$85**

Brushed Nickel **\$110**



136 5' reinforced pvc hose

- 1/2" connection

Black **\$100**



Body jets #2582 - 2583

BODY JETS



2583 wavy body jet

- polished stainless steel construction
- wavy water movement: 15° up and 15° down

flow rate: 2.1 gpm

Stainless Steel

\$895

1 FUNCTION



2576 spin body jet

- solid brass construction
- 1 function: spinning jets
- 1/2" NPT female connection

flow rate: 1 gpm

Polished Chrome

\$195

Electro Black

\$335

Brushed Gold

\$335

✦ Custom Finish

\$390

1 FUNCTION



2575 spin body jet

- solid brass construction
- 1 function: spinning jets
- 1/2" NPT female connection

flow rate: 1 gpm

Polished Chrome

\$225

Electro Black

\$395

Brushed Gold

\$395

✦ Custom Finish

\$450

1 FUNCTION



2574 spin body jet

- solid brass construction
- 1 function: spinning jets
- 1/2" NPT female connection

flow rate: 1 gpm

Polished Chrome

\$225

Electro Black

\$395

Brushed Gold

\$395

✦ Custom Finish

\$450

1 FUNCTION



BODY JETS



2566 round body jet

- solid brass construction
- 1 function: jet
- pivoting head
- 1/2" NPT connection

flow rate: 1.5 gpm

1 FUNCTION



Polished Chrome	\$85
Brushed Nickel	\$115
Electro Black	\$145



2565 square body jet

- solid brass construction
- 1 function: jet
- pivoting head
- 1/2" NPT connection

flow rate: 1.5 gpm

1 FUNCTION



Polished Chrome	\$95
Brushed Nickel	\$125

CHUTES



2582 wavy rain cascade

Stainless Steel **\$895**

- polished stainless steel construction
- wavy water movement: 0° to 30° down

flow rate: 2.1 gpm

1 FUNCTION

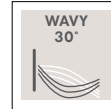

2581 recessed cascading chute

Polished Chrome **\$995**

Brushed Nickel **\$1745**

Electro Black **\$1745**

Brushed Gold **\$1745**

- function: cascade
- stainless steel construction
- 7" wide cascading chute
- 1/2" NPT male connection

width: 11^{13/16"} height: 5^{11/16"}

flow rate: 2.5 gpm

1 FUNCTION

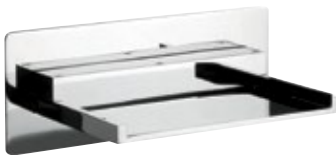

77346 wallmount cascading chute

Polished Chrome **\$1975**

Brushed Nickel **\$2555**

- function: cascade
- solid brass construction
- 8" wide cascading chute
- 1/2" NPT male connection

width: 9^{5/8"} height: 4" projection: 5^{1/2"}

flow rate: 2.5 gpm

1 FUNCTION



67746 wallmount cascading chute

Polished Chrome **\$1475**

Brushed Nickel **\$1895**

- function: cascade
- solid brass construction
- 4^{3/4"} wide cascading chute
- 1/2" NPT male connection

height: 2^{1/2"}

projection: 5^{7/8"}

flow rate: 2.5 gpm

1 FUNCTION



TUB SPOUTS WITHOUT DIVERTER



11132 7" round tub spout
• 1/2" slip-fit connection

Polished Chrome	\$105
Brushed Nickel	\$135
Electro Black	\$135
Brushed Gold	\$185
✦ Custom Finish	\$210



11732 7" square tub spout
• 1/2" slip-fit connection

Polished Chrome	\$145
Brushed Nickel	\$185
Electro Black	\$185
Brushed Gold	\$255
✦ Custom Finish	\$290



12032 4^{3/4}" round tub spout
• 1/2" slip-fit connection

Polished Chrome	\$95
Brushed Nickel	\$125
Electro Black	\$175



92032 8.5" square tub spout
• 1/2" NPT male connection

Polished Chrome	\$395
Brushed Nickel	\$495



19032 CHICANE 9" square tub spout
• 1/2" NPT male connection

Polished Chrome	\$525
Brushed Nickel	\$685



11932 7" square wallmount cascading tub spout
• 1/2" NPT male connection

Polished Chrome	\$245
Brushed Nickel	\$315

TUB SPOUTS WITH DIVERTER

10332 5^{1/4}" round tub spout
 • 1/2" slip-fit connection



Polished Chrome **\$35**
 Brushed Nickel **\$45**

11812 7" round tub spout
 • 1/2" slip-fit connection



Polished Chrome **\$55**
 Brushed Nickel **\$70**

10232 5^{1/2}" square tub spout
 • 1/2" slip-fit connection



Polished Chrome **\$90**
 Brushed Nickel **\$115**

11632 5^{1/4}" square tub spout
 • 1/2" NPT male connection



Polished Chrome **\$245**
 Brushed Nickel **\$315**



Cura #917

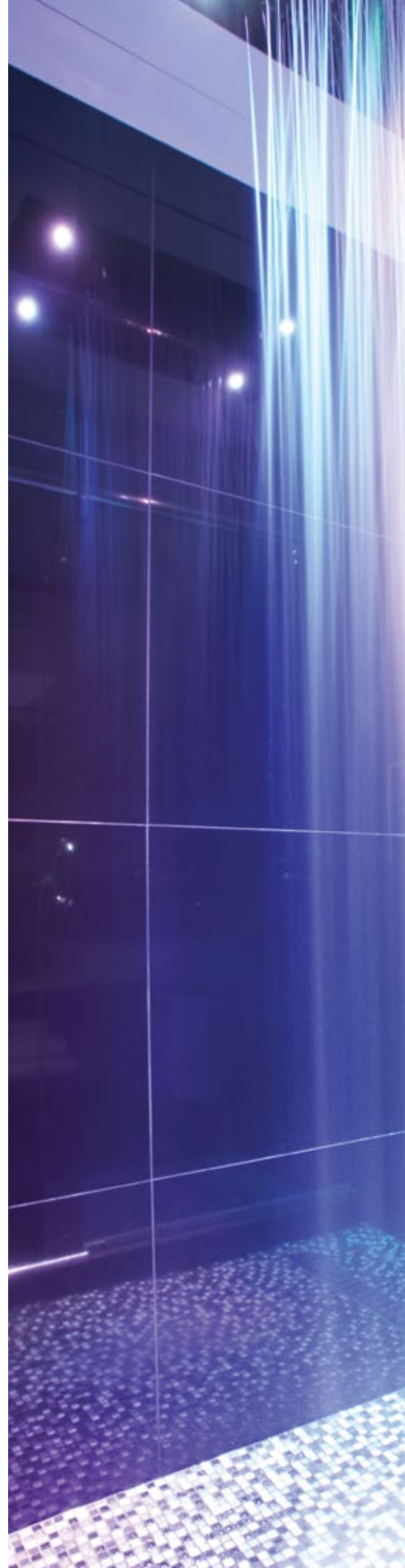

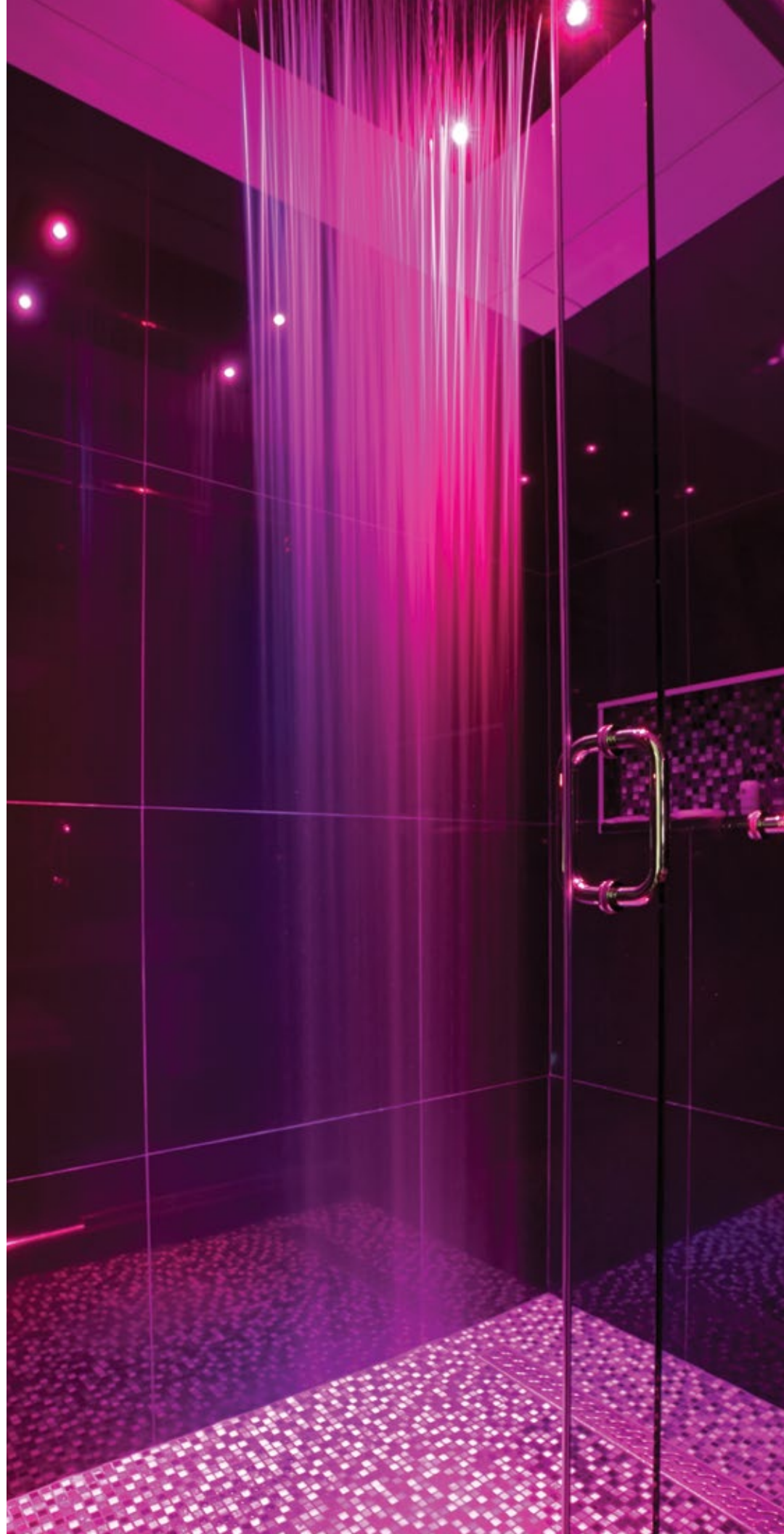

WELLNESS

Imagine stepping into your shower and enjoying an authentic spa experience, where you can uplift, unwind or simply get away.

When relaxation and well-being are the ultimate quest in a bathroom escape, the Cura rainheads series are an ideal destination for a mental and physical boost.

CHROMATHERAPY

Chromatherapy is an age-old form of healing that mixes color and light, recognized for its ability to improve one's mood and overall health.

All Cura rainheads offer healing shades of green, red and blue – each one with its own therapeutic properties and intensity.



Blue
Relaxation
Tranquility



Green
Harmony
Balance

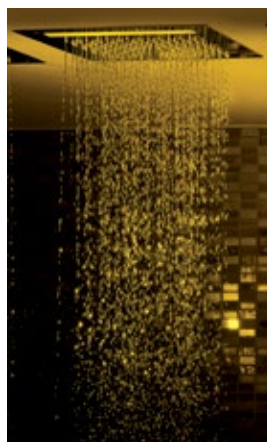

Yellow
Inspiration
Cheerfulness

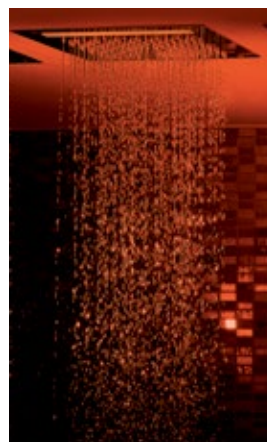

Red
Stimulation
Energy



Purple
Imagination
Creativity



AROMATHERAPY

Described as a gentle treatment that uses aromatic plant extracts and essential oils, aromatherapy is a natural alternative that enhances well-being.

Cura rainheads #925 and #928 come with a wallmounted diffuser system and three unique fragrances.

 **FLORAL**
Balancing

 **ENERGY**
Stimulating

 **RELAX**
Soothing



957 CURA 12" x 8" recessed rainhead

- 2 functions: rain, mist
- chromatherapy: 7 colors with adjustable light program
- stainless steel
- thermostatic valve required (minimum of 2 volume controls)

flow rate: varies between functions

2 FUNCTIONS

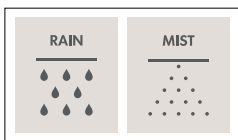

Polished Stainless Steel

\$1395



waterproof wallmount remote control
for chromatherapy included

916 CURA 16" x 10" recessed rainhead

- 1 function: rain
- chromatherapy - 16 color shades from 2 RGB LED lamps
- wallmount digital touchpad (3 settings)
- stainless steel construction
- thermostatic valve required (minimum of 1 volume control)

flow rate: 2.5 gpm

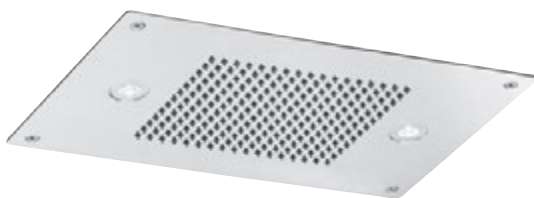

1 FUNCTION

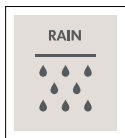

Touchpad

INCLUDED WITH CURA 916:

touchpad

- 1 on / off
- 2 color selection
- 3 chromatherapy function selector (color rotation, color set, on / off)



Chromatherapy - 16 color shades

Polished Stainless Steel

\$2995

CURA

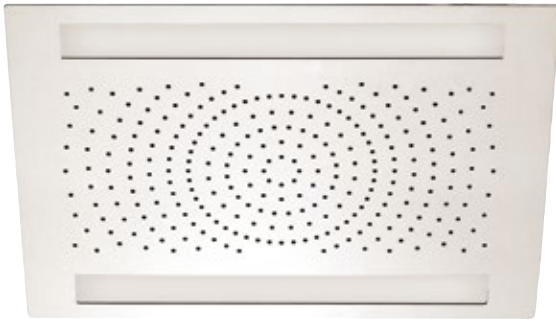

952 CURA 24" x 18" recessed rainhead

- 1 function: rain
- chromatherapy: 7 colors with adjustable light program
- stainless steel
- thermostatic valve required (minimum of 1 volume control)

flow rate: 2.5 gpm

Polished Stainless Steel

\$3795

1 FUNCTION

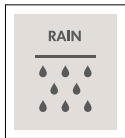

waterproof wallmount remote control
for chromatherapy included

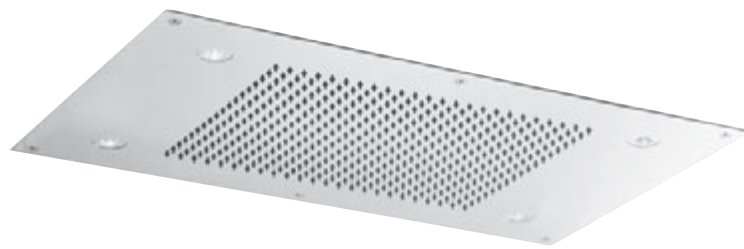

917 CURA 27" x 16" recessed rainhead

- 1 function: rain
- chromatherapy - 16 color shades from 4 RGB LED lamps
- wallmount digital touchpad (3 settings)
- stainless steel construction
- thermostatic valve required (minimum of 1 volume control)

flow rate: 2.5 gpm

INCLUDED WITH CURA 917:

touchpad

- 1** on / off
- 2** color selection
- 3** chromatherapy function selector (color rotation, color set, on / off)

1 FUNCTION

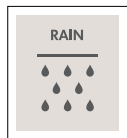

Touchpad



Chromatherapy - 16 color shades

Polished Stainless Steel

\$4595

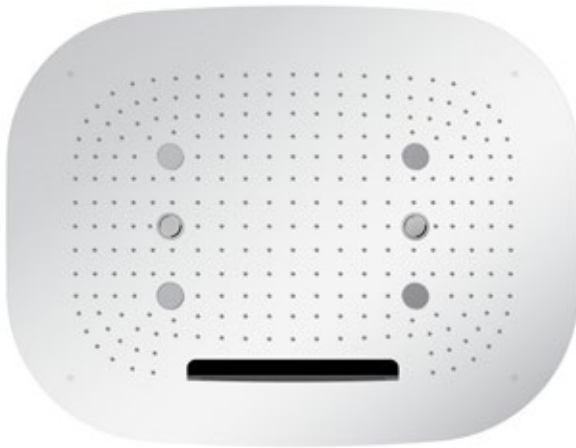

945 CURA 25" x 19" recessed rainhead

- 3 functions: rain, mist, cascading chute
- chromatherapy: 7 colors with adjustable light program
- stainless steel
- thermostatic valve required (minimum of 3 volume controls)

flow rate: varies between functions

Polished Stainless Steel **\$4595**

3 FUNCTIONS

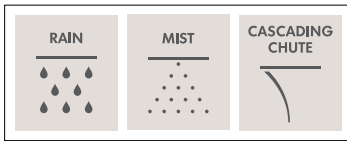

waterproof wallmount remote control
for chromatherapy included

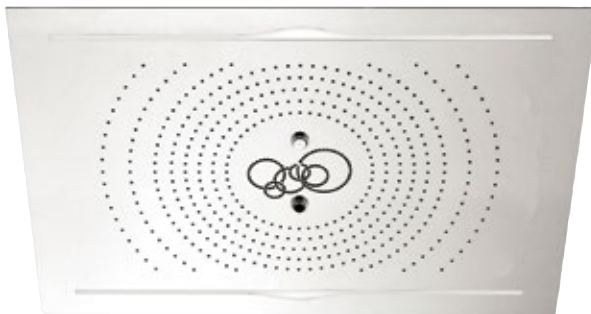

958 CURA 24" x 18" recessed rainhead

- 4 functions: rain, intense rain, mist, water column
- chromatherapy: 7 colors with adjustable light program
- stainless steel
- thermostatic valve required (minimum of 4 volume controls)

flow rate: varies between functions

Polished Stainless Steel **\$5195**

4 FUNCTIONS

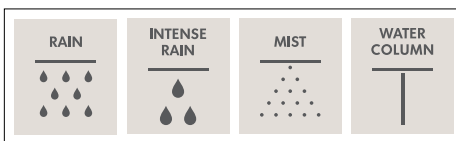

waterproof wallmount remote control
for chromatherapy included

CURA

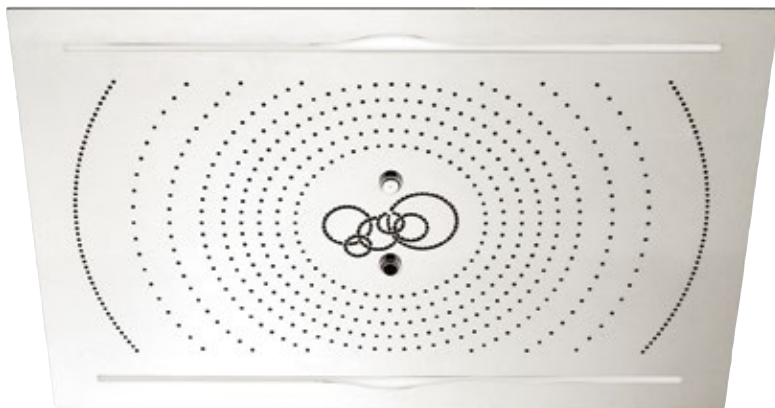

960 CURA 40" x 28" recessed rainhead

- 5 functions: rain, intense rain, curtain rain, mist, water column
- chromatherapy: 7 colors with adjustable light program
- stainless steel
- thermostatic valve required (minimum of 5 volume controls)

flow rate: varies between functions

Polished Stainless Steel **\$6995**

5 FUNCTIONS

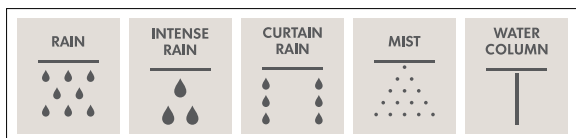

waterproof wallmount remote control for chromatherapy included

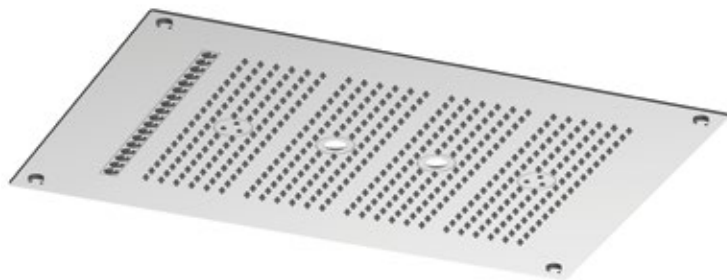

922 CURA 22" x 15" recessed rainhead

- 3 functions: rain, mist, rain chute
- chromatherapy - 16 color shades from 2 RGB LED lamps
- wallmount digital touchpad (3 settings)
- stainless steel construction
- thermostatic valve with 3 shut-off valves required

flow rate: 2.5 gpm

INCLUDED WITH CURA 916:

touchpad

- 1 on / off
- 2 color selection
- 3 chromatherapy function selector (color rotation, color set, on / off)

3 FUNCTIONS

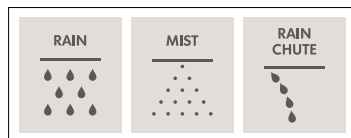

Touchpad



Chromatherapy - 16 color shades

Polished Stainless Steel **\$7995**

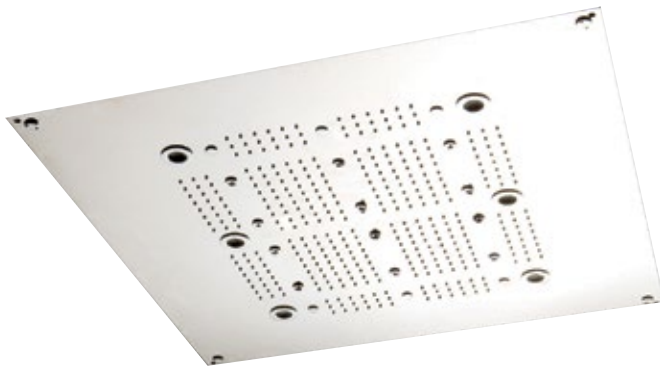

925 CURA 24" x 24" recessed rainhead

- 4 functions: central rain, complete rain, curtain rain, mist
- chromatherapy - 16 color shades from 6 RGB LED lamps
- aromatherapy - 3 scents: floral, relax, energy (wallmount diffuser included)
- wallmount digital touchpad (5 settings)
- stainless steel construction

flow rate: varies between functions

thermostatic valve required (service valve recommended)

INCLUDED WITH CURA 925:

touchpad

- 1 on / off
- 2 function selector (solenoid circuits)
- 3 chromatherapy function selector (color rotation, color set, on / off)
- 4 color selection
- 5 aromatherapy on / off

aromatherapy diffuser

- integrated fan system diffuses the fragrance every 30 seconds for a period of 10 seconds
- 3 fragrances available: FLORAL, RELAX and ENERGY
- a set of all three cartridges is included

4 FUNCTIONS

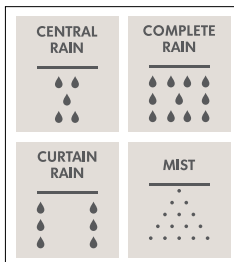

Touchpad



Aromatherapy diffuser



Chromatherapy - 16 color shades

Polished Stainless Steel

\$9995



replacement cartridge for aromatherapy diffuser

RX900 RELAX

FL900 FLORAL

EN900 ENERGY

\$90 / each

CURA



4 FUNCTIONS

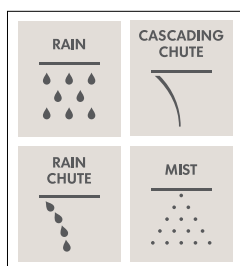

Touchpad



Aromatherapy diffuser



Chromotherapy - 16 color shades

928 CURA 24" x 24" recessed rainhead

- 4 functions: rain, cascading chute, rain chute, mist
- chromotherapy - 16 color shades from 4 RGB LED lamps
- aromatherapy - 3 scents: floral, relax, energy (wallmount diffuser included)
- wallmount digital touchpad (5 settings)
- stainless steel construction

flow rate: varies between functions

thermostatic valve required (service valve recommended)

INCLUDED WITH CURA 925:

touchpad

- 1** on / off
- 2** function selector (solenoid circuits)
- 3** chromotherapy function selector (color rotation, color set, on / off)
- 4** color selection
- 5** aromatherapy on / off

aromatherapy diffuser

- integrated fan system diffuses the fragrance every 30 seconds for a period of 10 seconds
- 3 fragrances available: FLORAL, RELAX and ENERGY
- a set of all three cartridges is included

Polished Stainless Steel

\$12550

replacement cartridge for aromatherapy diffuser



RX900 RELAX

FL900 FLORAL

EN900 ENERGY

\$90 / each

TICK ALL THE BOXES WITH

INABOX

ALL-IN-ONE SHOWER SOLUTION

INABOX

TICKING ALL THE BOXES

INABOX TICKS ALL THE BOXES TO PROVIDE THE MOST COMPLETE AND VERSATILE CONTEMPORARY THERMOSTATIC SHOWER SYSTEM IN ONE COMPACT DESIGNED BOX.

NO MORE COMPROMISE!
ALL THE OPTIONS TO BUILD A DREAM SHOWER FAUCET ARE INCLUDED WITH INABOX.



START WITH THE BEST ENGINE!

An Italian made thermostatic valve with a built-in diverter offering multiple configuration solutions for a 2- or 3- function shower - shared or not shared - with universal 3/4" and 1/2" connections (details p.250).

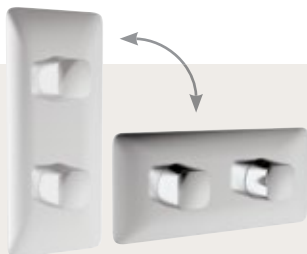

STYLISH VERSATILE TRIM SET

A modern and compact decorative trim set with easy clip-on fastening system and hidden 1^{3/8}" adjustment to fit any wall thickness. It can also accommodate a horizontal or vertical installation.

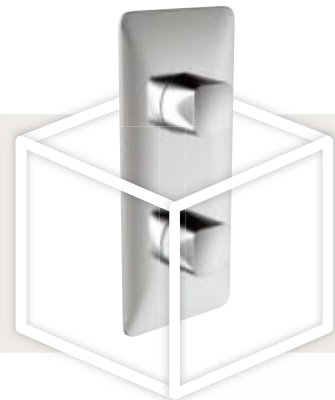



OVERSIZED RAINHEAD

The rain falling from the perfectly sized 14" x 8" rectangular rainhead submerges the body while not wasting water directly to the drain. With the included set of 2 arms, the rainhead can be installed on the ceiling or on the wall.



PUSH-BUTTON MULTI-FUNCTION HANDSHOWER

A handshower with an integrated ergonomic mode selector to experience 3 water flows: rain, massage and mist.



CHOICE OF HANDSHOWER SUPPORT

The handshower can be installed on a 24" rail or on a rotative hook, both included with INABOX.



ADJUSTABLE WATERWAY

The waterway has a 5/8" trim adjustment to elbow installation and an insulated casing.

For additional INABOX concepts, see pages 297 - 299

INABOX1

AVAILABLE Q1 2020

Included:
ceiling arm



INABOX-01 Shower faucet INABOX1

- thermostatic valve Uniplex 3/4" - 1/2" **sold separately**
- 2-way diverter, **2 functions working simultaneously**
- trim set with easy clip-on fastening system and hidden adjustment to fit any wall thickness
- 18" round shower arm & round flange
- 4" round arm included for ceiling installation
- 14" x 8" oversized rectangular rainhead
- push-button 3-function handshower (rain, mist, jet) with 28" overall shower rail
- adjustable round waterway
- handshower hook



Handshower supports included (rail and hook)



Horizontal or vertical installation

INABOX-01G Shower faucet INABOX1G CalGreen compliant option

- same components as above with a 2-way diverter, **one function at a time**

Polished Chrome	\$495
Brushed Nickel	\$695
Electro Black	\$750

REQUIRED VALVE

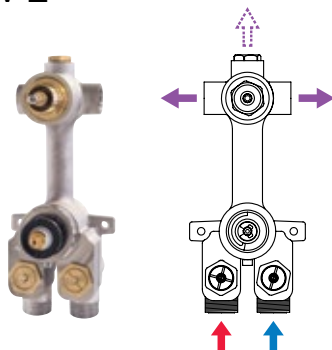

T-12123 TURBO thermostatic valve with diverter UNIPLEX 2/3 way

- can be installed horizontally or vertically

Rough	\$495
-------	--------------

Included:
ceiling arm



INABOX-02 Shower faucet INABOX2

- thermostatic valve Uniplex 3/4" - 1/2" **sold separately**
- 3-way diverter, **2 functions working simultaneously**
- trim set with easy clip-on fastening system and hidden adjustment to fit any wall thickness
- 18" round shower arm & round flange
- 4" round arm included for ceiling installation
- 14" x 8" oversized rectangular rainhead
- push-button 3-function handshower (rain, mist, jet) with 28" overall shower rail
- adjustable round waterway
- handshower hook
- tub spout



Handshower supports included (rail and hook)

Horizontal or vertical installation

INABOX-02G Shower faucet INABOX2G CalGreen compliant option

- same components as above with a 3-way diverter, **one function at a time**

Polished Chrome	\$590
Brushed Nickel	\$825
Electro Black	\$885

REQUIRED VALVE

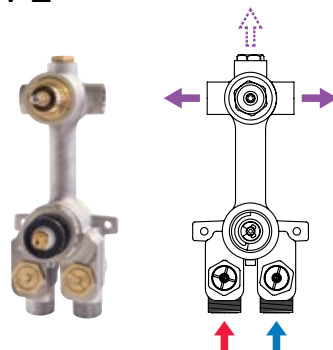

T-12123 TURBO thermostatic valve with diverter UNIPLEX 2/3 way

- **can be installed horizontally or vertically**

Rough	\$495
-------	--------------

INABOX3

AVAILABLE Q1 2020

Included:
ceiling arm



INABOX-03 Shower faucet INABOX3

- thermostatic valve Uniplex 3/4" - 1/2" sold separately
- 3-way diverter, **2 functions working simultaneously**
- trim set with easy clip-on fastening system and hidden adjustment to fit any wall thickness
- 18" round shower arm & round flange
- 4" round arm included for ceiling installation
- 14" x 8" oversized rectangular rainhead
- push-button 3-function handshower (rain, mist, jet) with 28" overall shower rail
- adjustable round waterway
- handshower hook
- round body jets (3)



Handshower supports included (rail and hook)



Horizontal or vertical installation

INABOX-03G Shower faucet INABOX3G CalGreen compliant option

- same components as above with a 3-way diverter, **one function at a time**



Polished Chrome	\$750
Brushed Nickel	\$1050
Electro Black	\$1125

REQUIRED VALVE

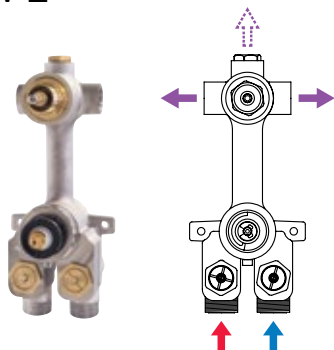

T-12123 TURBO thermostatic valve with diverter UNIPLEX 2/3 way

- can be installed horizontally or vertically

Rough	\$495
-------	--------------



INABOX-04 Shower faucet INABOX4

- thermostatic valve Uniplex 3/4" - 1/2" **sold separately**
- 3-way diverter, **2 functions working simultaneously**
- trim set with easy clip-on fastening system and hidden adjustment to fit any wall thickness
- Aquasheet wallmount dual function rainhead
- push-button 3-function handshower (rain, mist, jet) with 28" overall shower rail
- adjustable round waterway
- handshower hook



Handshower supports included (rail and hook)

Horizontal or vertical installation

INABOX-04G Shower faucet INABOX4G CalGreen compliant option

- same components as above with a 3-way diverter, **one function at a time**

Polished Chrome	\$1195
Brushed Nickel	\$1595
Electro Black	\$1795

REQUIRED VALVE

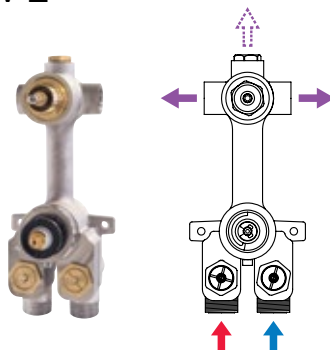

T-12123 TURBO thermostatic valve with diverter UNIPLEX 2/3 way

- **can be installed horizontally or vertically**

Rough	\$495
-------	--------------

ACCESSORIES



BASKETS



2001 concealed corner basket

- solid brass construction
- removable basket for cleaning purposes

6" x 3"

Polished Chrome **\$145**
 Black **\$185**
 Brushed Gold PVD **\$205**



2007 corner basket

- solid brass construction

9" x 1^{1/2}"

Polished Chrome **\$135**
 Brushed Nickel **\$175**



2072 corner basket

- solid brass construction

8" x 2^{3/4}"

Polished Chrome **\$115**
 Brushed Nickel **\$145**



2021 corner basket

- solid brass construction

5" x 1^{1/4}"

Polished Chrome **\$65**
 Brushed Nickel **\$85**

BASKETS

2037 rectangular basket

- solid brass construction

10" x 1^{3/4}"



Polished Chrome **\$165**
Brushed Nickel **\$215**

2054 rectangular basket with razor holder

- solid brass construction

11^{1/2}" x 4^{3/4}"



Polished Chrome **\$135**
Brushed Nickel **\$175**

2040 rectangular two level basket

- solid brass construction

10^{1/4}" x 5"



Polished Chrome **\$115**
Brushed Nickel **\$145**

2004 rectangular basket

- solid brass construction

5^{1/4}" x 3^{3/4}"



Polished Chrome **\$65**
Brushed Nickel **\$85**

BASKETS



2068 two tier rectangular basket

- solid brass construction

10^{3/4}" x 11^{1/4}"

Polished Chrome

\$245

Brushed Nickel

\$325



2067 two tier triangular basket

- solid brass construction

11^{1/2}" x 8"

Polished Chrome

\$215

Brushed Nickel

\$275



2065 two tier triangular basket

- solid brass construction

10^{1/2}" x 7"

Polished Chrome

\$175

Brushed Nickel

\$230

SERIE A100

A103 24" wallmount single towel bar

Polished Chrome	\$155
Black	\$195
Brushed Gold PVD	\$235



A107 8" wallmount towel ring

Polished Chrome	\$115
Black	\$145
Brushed Gold PVD	\$165



A111 6 1/2" wallmount paper holder

Polished Chrome	\$95
Black	\$125
Brushed Gold PVD	\$135



A108 wallmount hook

Polished Chrome	\$45
Black	\$60
Brushed Gold PVD	\$70



SERIE A200



A203 24" wallmount single towel bar

Polished Chrome **\$215**
 Black **\$275**
 Brushed Gold PVD **\$295**



A207 10" wallmount towel holder

Polished Chrome **\$135**
 Black **\$175**
 Brushed Gold PVD **\$185**



A211 5" wallmount paper holder

Polished Chrome **\$105**
 Black **\$135**
 Brushed Gold PVD **\$145**



A208 wallmount hook

Polished Chrome **\$85**
 Black **\$105**
 Brushed Gold PVD **\$115**

SERIE B9700



B9706 19" wallmount single towel bar

Polished Chrome	\$410
Brushed Nickel	\$535
Brushed Gold	\$715
◆ Custom Finish	\$820



B9710 wallmount glass shelf
17^{3/4}" x 4"

Polished Chrome	\$460
Brushed Nickel	\$595
Brushed Gold	\$805
◆ Custom Finish	\$920



B9707 12^{1/2}" wallmount towel holder

Polished Chrome	\$360
Brushed Nickel	\$470
Brushed Gold	\$630
◆ Custom Finish	\$720



B9711 5^{3/4}" wallmount paper holder

Polished Chrome	\$270
Brushed Nickel	\$350
Brushed Gold	\$475
◆ Custom Finish	\$540



B9708 wallmount hook

Polished Chrome	\$195
Brushed Nickel	\$255
Brushed Gold	\$340
◆ Custom Finish	\$390

SERIE 1500

1503 24" wallmount single towel bar



Polished Chrome	\$175
Brushed Nickel	\$230
Custom Finish	\$350

1510 wallmount glass shelf

27^{1/2}" x 4"



Polished Chrome	\$290
Brushed Nickel	\$375
Custom Finish	\$580

1504 24" wallmount double towel bar



Polished Chrome	\$290
Brushed Nickel	\$375
Custom Finish	\$580

1507 9^{1/2}" wallmount towel holder

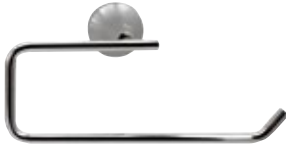

Polished Chrome	\$130
Brushed Nickel	\$165
Custom Finish	\$260

1511 6^{1/2}" wallmount paper holder



Polished Chrome	\$120
Brushed Nickel	\$155
Custom Finish	\$240

1508 wallmount hook



Polished Chrome	\$80
Brushed Nickel	\$100
Custom Finish	\$160

SERIE 3500

3503 24" wallmount single towel bar

Polished Chrome **\$210**



3507 8^{3/4}" wallmount towel holder

Polished Chrome **\$180**



3511 7^{1/2}" wallmount paper holder

Polished Chrome **\$130**

• vertical or horizontal installation



3508 wallmount hook

Polished Chrome **\$105**



SERIE 4100



4103 24" wallmount single towel bar

Polished Chrome	\$100
Brushed Nickel	\$130
Custom Finish	\$200



4104 wallmount double towel bar

Polished Chrome	\$170
Brushed Nickel	\$225
Custom Finish	\$340



4107 7" wallmount towel ring

Polished Chrome	\$90
Brushed Nickel	\$115
Custom Finish	\$180



4111 6" wallmount paper holder





Polished Chrome	\$90
Brushed Nickel	\$115
Custom Finish	\$180



4108 wallmount hook

Polished Chrome	\$50
Brushed Nickel	\$65
Custom Finish	\$100

SERIE 4500

	<p>4503 24" wallmount single towel bar</p>	<p>Polished Chrome \$165 Brushed Nickel \$215</p>
	<p>4510 wallmount glass shelf 20" x 4^{3/4}"</p>	<p>Polished Chrome \$205 Brushed Nickel \$270</p>
	<p>4507 8^{1/2}" wallmount towel ring</p>	<p>Polished Chrome \$125 Brushed Nickel \$160</p>
	<p>4511 5" wallmount paper holder</p>	<p>Polished Chrome \$125 Brushed Nickel \$160</p>
	<p>4501 wallmount soap dish • glass soap dish</p>	<p>Polished Chrome \$125 Brushed Nickel \$160</p>
	<p>4502 wallmount tumbler holder • glass tumbler</p>	<p>Polished Chrome \$125 Brushed Nickel \$160</p>
	<p>4508 wallmount hook</p>	<p>Polished Chrome \$70 Brushed Nickel \$90</p>

SERIE 4700

4703 24" wallmount single towel bar

Polished Chrome

\$205



4707 8^{3/4}" wallmount towel ring

Polished Chrome

\$160



4711 7^{1/2}" wallmount paper holder

Polished Chrome

\$115

• vertical or horizontal installation



4708 wallmount hook

Polished Chrome

\$80



SERIE 6100

6103 24" wallmount single towel bar

Polished Chrome

\$310



6107 10" wallmount towel ring

Polished Chrome

\$180



6111 7" wallmount paper holder

Polished Chrome

\$160

• vertical or horizontal installation



6108 wallmount hook

Polished Chrome

\$110



SERIE 8600



8603 24" wallmount single towel bar

Polished Chrome

\$340



8607 9" wallmount towel ring

Polished Chrome

\$205



8611 7¹/₂" wallmount paper holder

Polished Chrome

\$175



8608 wallmount hook

Polished Chrome

\$125

SERIE 400



406 18" wallmount single towel bar

- Polished Chrome **\$130**
- Brushed Nickel **\$165**
- Custom Finish **\$260**



403 24" wallmount single towel bar

- Polished Chrome **\$140**
- Brushed Nickel **\$180**
- Custom Finish **\$280**



409 30" wallmount single towel bar

- Polished Chrome **\$150**
- Brushed Nickel **\$200**
- Custom Finish **\$300**

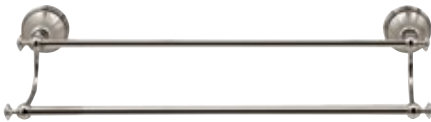

405 20" wallmount double towel bar

- Polished Chrome **\$235**
- Brushed Nickel **\$310**
- Custom Finish **\$470**



407 8" wallmount towel ring

- Polished Chrome **\$120**
- Brushed Nickel **\$155**
- Custom Finish **\$240**



411 7 1/2" wallmount paper holder

- Polished Chrome **\$120**
- Brushed Nickel **\$155**
- Custom Finish **\$240**



408 wallmount hook

- Polished Chrome **\$90**
- Brushed Nickel **\$115**
- Custom Finish **\$180**

KITCHEN



MARGHERITA PULL-DOWN



3 MODES

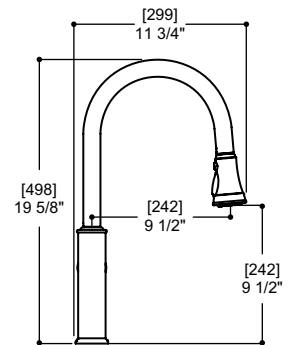
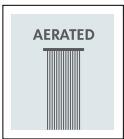

6845N MARGHERITA
pull-down dual stream mode kitchen faucet

- 2 stream modes: aerated + spray + sweep
- lead-free brass construction
- single volume and temperature lever control
- 360° spout rotation
- 3/8" connection

height: 19^{5/8}"
projection: 11^{3/4}"
flow rate: 2 gpm



Polished Chrome **\$395**
Brushed Nickel PVD **\$495**
Brushed Gold PVD **\$595**

BARLEY PULL-DOWN

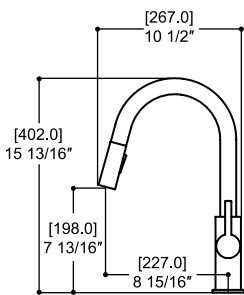

2 MODES

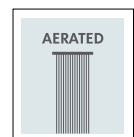

6545N BARLEY
pull-down dual stream mode kitchen faucet

- 2 stream modes: aerated + spray
- lead-free brass construction
- single volume and temperature lever control
- 140° spout rotation
- 3/8" connection

height: 15^{13/16}"
 projection: 10^{1/2}"
 flow rate: 2.2 gpm



Polished Chrome **\$445**
 Brushed Nickel PVD **\$550**
 Brushed Gold **\$650**

BARLEY PREP PULL-DOWN



2 MODES

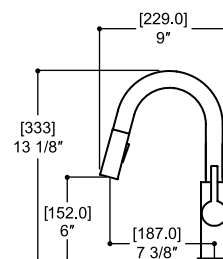
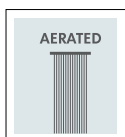

6545B BARLEY PREP pull-down dual stream mode kitchen faucet

- 2 stream modes: aerated + spray
- lead-free brass construction
- single volume and temperature lever control
- 140° spout rotation
- 3/8" connection

height: 13 1/8"
 projection: 9"
 flow rate: 2.2 gpm



- Polished Chrome **\$395**
- Brushed Nickel PVD **\$495**
- Brushed Gold **\$595**

GRILL PULL-DOWN

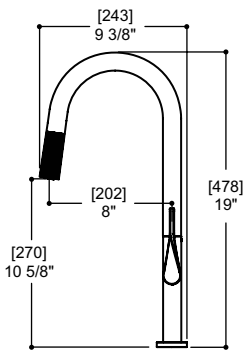

2 MODES

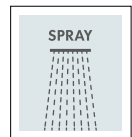
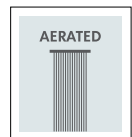

6745N GRILL pull-down dual stream mode kitchen faucet

- 2 stream modes: aerated + spray
- lead-free brass construction
- single volume and temperature lever control
- 360° spout rotation
- 3/8" connection

height: 19"
projection: 9³/₈"
flow rate: 2 gpm



Polished Chrome	\$550
Brushed Nickel	\$725
Electro Black	\$725
Brushed Gold	\$850

TIRAMISU PULL-DOWN



2 MODES

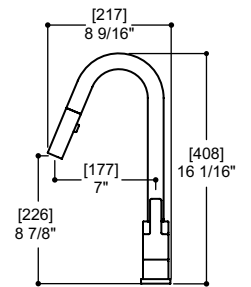
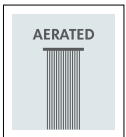

3145N TIRAMISU
pull-down dual stream mode kitchen faucet

- 2 stream modes: aerated + spray
- lead-free brass construction
- single volume and temperature lever control
- 150° spout rotation
- 3/8" connection

height: 16 ¹/₁₆"
 projection: 8 ⁹/₁₆"
 flow rate: 2 gpm



- Polished Chrome **\$495**
- Brushed Nickel PVD **\$595**
- Electro Black **\$595**

BAGUETTE PULL-DOWN

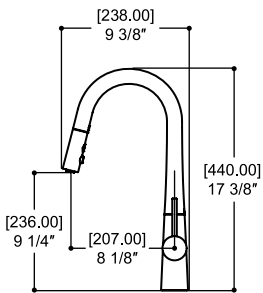

2 MODES

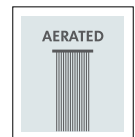

7145N BAGUETTE pull-down dual stream mode kitchen faucet

- 2 stream modes: aerated + spray
- lead-free brass construction
- single volume and temperature lever control
- 150° spout rotation
- 3/8" connection

height: 17^{3/8}"

projection: 9^{3/8}"

flow rate: 1.75 gpm



ALT755736

Polished Chrome **\$395**

Brushed Nickel PVD **\$495**

Electro Black **\$495**

URBAN SINGLE-SPRAY



1 MODE

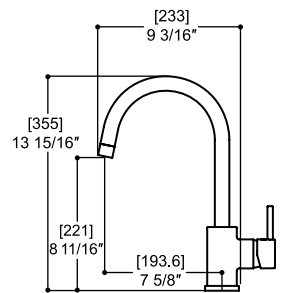
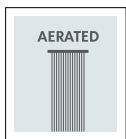

8045N URBAN
single stream mode kitchen faucet

Polished Chrome **\$259**

- aerated stream mode
- lead-free brass construction
- single volume and temperature lever control
- 140° spout rotation
- 3/8" connection

height: 13^{15/16}"
projection: 9^{3/16}"
flow rate: 2.2 gpm



ABCA60048

STUDIO PULL-DOWN

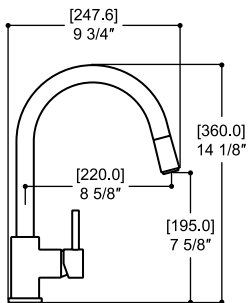

1 MODE

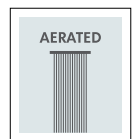

3345N STUDIO
pull-down single stream mode kitchen faucet

- aerated stream mode
- lead-free solid brass construction
- single volume and temperature lever control
- 150° spout rotation
- 3/8" connection

height: 14^{1/8}"

projection: 9^{3/4}"

flow rate: 2.2 gpm



ABCA33499

Polished Chrome **\$325**
Brushed Nickel **\$425**

PULMI PULL-DOWN



2 MODES

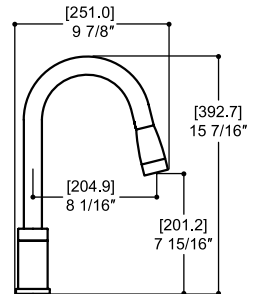
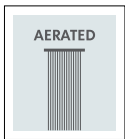

33045 PULMI pull-down dual stream mode kitchen faucet

- 2 stream modes: aerated + spray
- lead-free brass construction
- single volume and temperature lever control
- 360° spout rotation
- 3/8" connection

height: 15^{7/16}"
 projection: 9^{7/8}"
 flow rate: 2 gpm



Polished Chrome **\$345**
 Brushed Nickel PVD **\$445**

QUINOA JOY SLIM PULL-DOWN



6045J QUINOA JOY SLIM
pull-down dual stream mode kitchen faucet with
side joystick

- 2 stream modes: aerated + spray
- lead-free brass construction
- single volume and temperature side joystick control
- 100° spout rotation
- 3/8" connection

height: 16^{5/16"}

projection: 10^{3/4"}

flow rate: 2.2 gpm

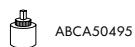

Polished Chrome **\$745**
Brushed Nickel **\$965**

side joystick control can be installed in different locations

EATALIA PULL-OUT



2 MODES

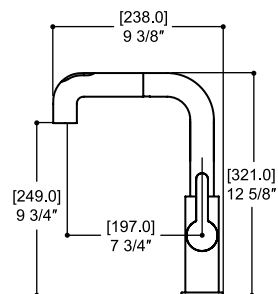
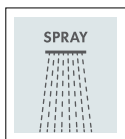
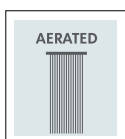

5043N EATALIA pull-out dual stream mode kitchen faucet

- 2 stream modes: aerated + spray
- lead-free brass construction
- single volume and temperature lever control
- 150° spout rotation
- 3/8" connection

height: 12^{5/8}"
projection: 9^{3/8}"
flow rate: 2.2 gpm

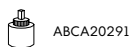

Polished Chrome **\$650**
Brushed Nickel **\$850**

WIZARD PRO-CHEF

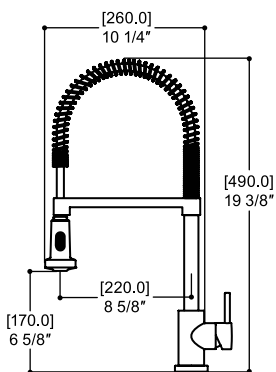

2 MODES

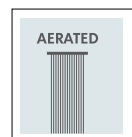

30045 WIZARD pull-out dual stream mode kitchen faucet

- 2 stream modes: aerated + spray
- flexible nylon braided hose with coil
- lead-free solid brass construction
- single volume and temperature lever control
- 360° spout rotation
- 3/8" connection

height: 19^{3/8}"

projection: 10^{1/4}"

flow rate: 2.2 gpm



ABCA30099

Polished Chrome **\$595**
Brushed Nickel **\$795**

ZEST PRO-CHEF



2 MODES

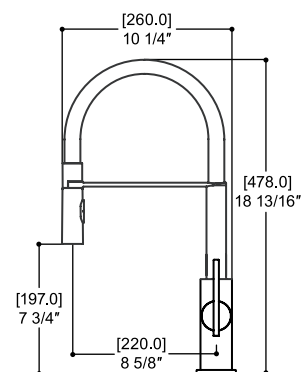
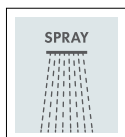
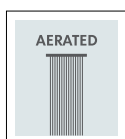

3845N ZEST
pull-out dual stream mode kitchen faucet

- 2 stream modes: aerated + spray
- flexible spring hose
- lead-free brass construction
- single volume and temperature lever control
- 150° spout rotation
- 3/8" connection

height: 18^{13/16"}
 projection: 10^{1/4"}
 flow rate: 2.2 gpm

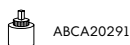

Polished Chrome **\$695**
 Brushed Nickel **\$895**

ZEST NERO PRO-CHEF

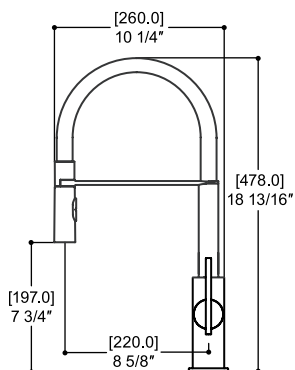

2 MODES

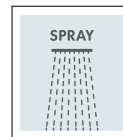
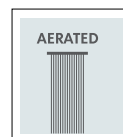

3745N ZEST NERO
pull-out dual stream mode kitchen faucet

- 2 stream modes: aerated + spray
- flexible matte PVC black hose
- lead-free brass construction
- single volume and temperature lever control
- 150° spout rotation
- 3/8" connection

height: 18 ¹³/₁₆"
 projection: 10 ¹/₄"
 flow rate: 2.2 gpm

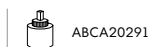

Polished Chrome **\$695**
 Brushed Nickel **\$895**

TAPAS PULL-OUT



2 MODES

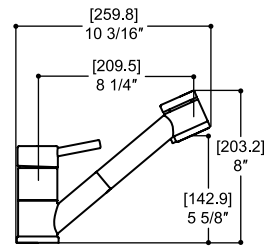
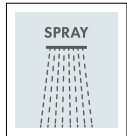
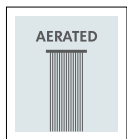

20343 TAPAS
pull-out dual stream mode kitchen faucet

- 2 stream modes: aerated + spray
- lead-free solid brass construction
- single volume and temperature lever control
- 100° spout rotation
- 3/8" connection

height: 8"
 projection: 10^{3/16}"
 flow rate: 2 gpm



Polished Chrome **\$250**
 Brushed Nickel PVD **\$320**

DOWNTON SPRAY SIDE SPRAY



4681S DOWNTON SPRAY
dual stream mode kitchen faucet with side spray

- 2 stream modes: aerated + spray
- lead-free brass construction
- single volume and temperature lever control
- 360° spout rotation
- 3/8" connection

height: 9^{3/16}"
projection: 11"
flow rate: 2 gpm



Polished Chrome **\$695**
Brushed Nickel **\$895**

NEW ENGLAND SPRAY SIDE SPRAY



2 MODES

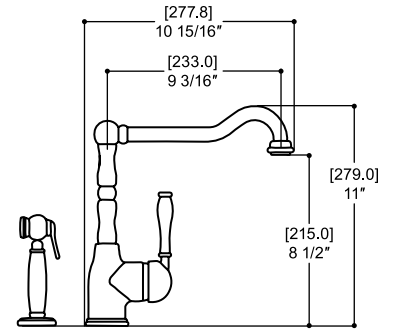
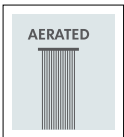

2150S NEW ENGLAND SPRAY
dual stream mode kitchen faucet with side spray

- 2 stream modes: aerated + spray
- lead-free brass construction
- single volume and temperature lever control
- 360° spout rotation
- 3/8" connection

height: 11"
 projection: 10^{15/16}"
 flow rate: 2 gpm

Polished Chrome **\$695**
 Brushed Nickel **\$895**



ACCESSORIES



40208 soap dispenser

Polished Chrome **\$80**
Brushed Nickel PVD **\$95**
Electro Black **\$95**
Brushed Gold PVD **\$110**



40218 soap dispenser

Polished Chrome **\$95**
Brushed Nickel PVD **\$125**
Electro Black **\$125**



40138 soap dispenser

Polished Chrome **\$70**
Brushed Nickel PVD **\$90**
Brushed Gold PVD **\$125**

140 10" cover plate

Polished Chrome **\$65**
Brushed Nickel **\$85**



134 4" cover plate

Polished Chrome **\$55**
Brushed Nickel **\$85**



aquabrass.com



North American exclusive distributor:

AD WATERS

www.ad-waters.com
Tel. 1 888 ADW-9336