

# simas

Est. 1955



Made in Italy for the North American market  
Fabriqué en Italie, pensé pour le marché nord américain



[simasusa.com](http://simasusa.com)

Nov. 2021



Certified products for North America  
Produits certifiés pour l'Amérique du Nord





**simas**

Est. 1955







# Index

## Table of contents & price list Table des matières et liste de prix

PRICE LIST LISTE DE PRIX	p.4
TOILETS AND BIDETS TOILETTES ET BIDETS	p.24
Wall hung Suspendus	p.29
Floormount Au sol	p.42
WASH BASINS LAVABOS	p.47
Countertop Sur comptoir	p.48
Under counter & vanity top Sous comptoir et dessus de vanité	p.64
Drop-in Encastrés	p.70
Wall hung Suspendus	p.77
CONSOLES	p.84
STRUCTURES & COUNTERTOPS STRUCTURES ET COMPTOIRS	p.94
MIRRORS MIROIRS	p.102



## Toilets & bidets – Wall hung Toilettes et bidets – Suspendus

Photo	Code	Page	Colors and prices (Stock / 90 days) Couleurs et prix (En inventaire / 90 jours)							
			White gloss Blanc lustré	Black matt Noir mat	White matt Blanc mat	Black gloss Noir lustré	Anthracite Anthracite	Lavender blue Bleu lavande	Navy Marine	Plum Prune
 <p>Bormio – Toilet / Toilette Seat included / Siège inclus 20<sup>1/2</sup>" x 13<sup>3/4</sup>" x 10<sup>1/4</sup>"</p>	BR18C	32	\$764. <sup>50</sup> stock	—	—	—	—	—	—	—
 <p>Bormio – Bidet 20<sup>1/2</sup>" x 13<sup>3/4</sup>" x 10<sup>1/4</sup>"</p>	BR19	33	\$654. <sup>50</sup> stock	—	—	—	—	—	—	—
 <p>Vignoni – Toilet / Toilette Seat included / Siège inclus 22<sup>1/16</sup>" x 14<sup>3/8</sup>" x 13<sup>1/2</sup>"</p>	VI18C	34	\$1094. <sup>50</sup> stock	\$1754. <sup>50</sup> stock	\$1754. <sup>50</sup> stock	\$1754. <sup>50</sup>	\$1754. <sup>50</sup>	—	—	—
 <p>Vignoni – Bidet 22<sup>1/16</sup>" x 14<sup>3/8</sup>" x 13<sup>1/2</sup>"</p>	VI19	35	\$874. <sup>50</sup> stock	\$1314. <sup>50</sup> stock	\$1314. <sup>50</sup> stock	\$1314. <sup>50</sup>	\$1314. <sup>50</sup>	—	—	—

**Toilets & bidets – Wall hung (continued)**  
**Toilettes et bidets – Suspendus (suite)**



Photo	Code	Page	Colors and prices (Stock / 90 days) Couleurs et prix (En inventaire / 90 jours)								
			White gloss Blanc lustré	Black matt Noir mat	White matt Blanc mat	Black gloss Noir lustré	Anthracite Anthracite	Lavender blue Bleu lavande	Navy Marine	Plum Prune	
 <p>Baden Baden – Toilet / Toilette Seat included / Siège inclus 22<sup>1/16</sup>" x 14<sup>3/16</sup>" x 12<sup>3/16</sup>"</p>	BB18C	36	\$1424 <sup>.50</sup> stock	\$2194 <sup>.50</sup>	\$2194 <sup>.50</sup>	\$2194 <sup>.50</sup>	\$2194 <sup>.50</sup>	\$2194 <sup>.50</sup>	—	—	—
 <p>Baden Baden – Bidet 22<sup>1/16</sup>" x 14<sup>3/16</sup>" x 12<sup>3/16</sup>"</p>	BB19	37	\$1094 <sup>.50</sup> stock	\$1754 <sup>.50</sup>	\$1754 <sup>.50</sup>	\$1754 <sup>.50</sup>	\$1754 <sup>.50</sup>	\$1754 <sup>.50</sup>	—	—	—
 <p>Flow – Toilet / Toilette Seat included / Siège inclus 19<sup>11/16</sup>" x 14<sup>1/4</sup>" x 9<sup>1/16</sup>"</p>	FL63C	38	\$1424 <sup>.50</sup> stock	—	\$2194 <sup>.50</sup>	\$2194 <sup>.50</sup>	\$2194 <sup>.50</sup>	\$2194 <sup>.50</sup>	—	—	—
 <p>Flow – Bidet 19<sup>11/16</sup>" x 14<sup>1/4</sup>" x 9<sup>1/16</sup>"</p>	FL64	39	\$1094 <sup>.50</sup> stock	—	\$1754 <sup>.50</sup>	\$1754 <sup>.50</sup>	\$1754 <sup>.50</sup>	\$1754 <sup>.50</sup>	—	—	—

**Toilets & bidets – Wall hung (continued)**  
**Toilettes et bidets – Suspendus (suite)**

Photo	Code	Page	Colors and prices (Stock / 90 days) Couleurs et prix (En inventaire / 90 jours)							
			White gloss Blanc lustré	Black matt Noir mat	White matt Blanc mat	Black gloss Noir lustré	Anthracite Anthracite	Lavender blue Bleu lavande	Navy Marine	Plum Prune
 <p>Arcadia – Toilet / Toilette Seat included / Siège inclus 20<sup>1</sup>/<sub>16</sub>" x 14<sup>3</sup>/<sub>8</sub>" x 11<sup>13</sup>/<sub>16</sub>"</p>	AR841C	40	<b>\$1424<sup>.50</sup></b> stock	—	—	—	—	—	—	—
 <p>Arcadia – Toilet / Toilette Seat included / Siège inclus 20<sup>1</sup>/<sub>16</sub>" x 14<sup>3</sup>/<sub>8</sub>" x 11<sup>13</sup>/<sub>16</sub>"</p>	AR851C	40	<b>\$1644<sup>.50</sup></b> stock	—	—	—	—	—	—	—
 <p>Arcadia – Bidet 20<sup>7</sup>/<sub>8</sub>" x 14<sup>3</sup>/<sub>8</sub>" x 11<sup>13</sup>/<sub>16</sub>"</p>	AR843	41	<b>\$984<sup>.50</sup></b> stock	—	—	—	—	—	—	—



## Toilets & bidets – Floormount Toilettes et bidets – Au sol





Photo	Code	Page	Colors and prices (Stock / 90 days) Couleurs et prix (En inventaire / 90 jours)								
			White gloss Blanc lustré	Black matt Noir mat	White matt Blanc mat	Black gloss Noir lustré	Anthracite Anthracite	Lavender blue Bleu lavande	Navy Marine	Plum Prune	
 <p>Vignoni – Toilet / Toilette Seat included / Siège inclus 22<sup>1/16</sup>" x 14<sup>3/8</sup>" x 16<sup>9/16</sup>"</p>	VI01C	44	\$1424 <sup>.50</sup> stock	\$2084 <sup>.50</sup>	\$2084 <sup>.50</sup>	\$2084 <sup>.50</sup>	\$2084 <sup>.50</sup>	\$2084 <sup>.50</sup>	—	—	—
 <p>Vignoni – Bidet 22<sup>1/16</sup>" x 14<sup>3/8</sup>" x 16<sup>9/16</sup>"</p>	VI04	46	\$1094 <sup>.50</sup> stock	\$1754 <sup>.50</sup>	\$1754 <sup>.50</sup>	\$1754 <sup>.50</sup>	\$1754 <sup>.50</sup>	\$1754 <sup>.50</sup>	—	—	—

## Wash basins – Countertop Lavabos – Sur comptoir





Photo	Code	Page	Colors and prices (Stock / 90 days) Couleurs et prix (En inventaire / 90 jours)							
			White gloss Blanc lustré	Black matt Noir mat	White matt Blanc mat	Black gloss Noir lustré	Anthracite Anthracite	Lavender blue Bleu lavande	Navy Marine	Plum Prune
 <p>ø 19<sup>11/16</sup>" x 5<sup>3/4</sup>"</p>	SH01	55	\$654. <sup>50</sup> stock	\$984. <sup>50</sup>	\$984. <sup>50</sup>	\$984. <sup>50</sup>	\$984. <sup>50</sup>	\$984. <sup>50</sup>	\$984. <sup>50</sup>	\$984. <sup>50</sup>
 <p>ø 16<sup>11/16</sup>" x 6<sup>3/8</sup>"</p>	SH02	56	\$654. <sup>50</sup> stock	\$984. <sup>50</sup> stock	\$984. <sup>50</sup>	\$984. <sup>50</sup>	\$984. <sup>50</sup>	\$984. <sup>50</sup>	\$984. <sup>50</sup>	\$984. <sup>50</sup>
 <p>ø 16<sup>11/16</sup>" x 6<sup>3/8</sup>"</p>	SH03	57	\$654. <sup>50</sup> stock	\$984. <sup>50</sup>	\$984. <sup>50</sup>	\$984. <sup>50</sup>	\$984. <sup>50</sup>	\$984. <sup>50</sup>	\$984. <sup>50</sup>	\$984. <sup>50</sup>
 <p>16<sup>11/16</sup>" x 16<sup>11/16</sup>" x 6<sup>3/8</sup>"</p>	SH06	58	\$654. <sup>50</sup> stock	\$984. <sup>50</sup> stock	\$984. <sup>50</sup>	\$984. <sup>50</sup>	\$984. <sup>50</sup>	\$984. <sup>50</sup>	\$984. <sup>50</sup>	\$984. <sup>50</sup>
 <p>16<sup>11/16</sup>" x 16<sup>11/16</sup>" x 6<sup>3/8</sup>"</p>	SH07	59	\$654. <sup>50</sup> stock	\$984. <sup>50</sup>	\$984. <sup>50</sup>	\$984. <sup>50</sup>	\$984. <sup>50</sup>	\$984. <sup>50</sup>	\$984. <sup>50</sup>	\$984. <sup>50</sup>

## Wash basins – Countertop (continued)

### Lavabos – Sur comptoir (suite)

Photo	Code	Page	Colors and prices (Stock / 90 days) Couleurs et prix (En inventaire / 90 jours)							
			White gloss Blanc lustré	Black matt Noir mat	White matt Blanc mat	Black gloss Noir lustré	Anthracite Anthracite	Lavender blue Bleu lavande	Navy Marine	Plum Prune
 <p>23<sup>13/16</sup>" x 16<sup>11/16</sup>" x 6<sup>3/8</sup>"</p>	SH08	60	\$764. <sup>50</sup> stock	\$1094. <sup>50</sup>	\$1094. <sup>50</sup>	\$1094. <sup>50</sup>	\$1094. <sup>50</sup>	\$1094. <sup>50</sup>	\$1094. <sup>50</sup>	\$1094. <sup>50</sup>
 <p>23<sup>13/16</sup>" x 16<sup>11/16</sup>" x 6<sup>3/8</sup>"</p>	SH09	61	\$764. <sup>50</sup> stock	\$1094. <sup>50</sup>	\$1094. <sup>50</sup>	\$1094. <sup>50</sup>	\$1094. <sup>50</sup>	\$1094. <sup>50</sup>	\$1094. <sup>50</sup>	\$1094. <sup>50</sup>
 <p>23<sup>5/8</sup>" x 16<sup>9/16</sup>" x 6<sup>1/2</sup>"</p>	WA02	62	\$874. <sup>50</sup> stock	\$1204. <sup>50</sup>	\$1204. <sup>50</sup>	\$1204. <sup>50</sup>	\$1204. <sup>50</sup>	\$1204. <sup>50</sup>	\$1204. <sup>50</sup>	\$1204. <sup>50</sup>
 <p>23<sup>5/8</sup>" x 15<sup>3/4</sup>" x 5<sup>1/8</sup>"</p>	AG60	63	\$984. <sup>50</sup> stock	\$1375	\$1375	\$1375	\$1375	\$1375	\$1375	\$1375

## Wash basins – Under counter & Vanity top Lavabos – Sous comptoir et dessus de vanité

Photo	Code	Page	Colors and prices (Stock / 90 days) Couleurs et prix (En inventaire / 90 jours)							
			White gloss Blanc lustré	Black matt Noir mat	White matt Blanc mat	Black gloss Noir lustré	Anthracite Anthracite	Lavender blue Bleu lavande	Navy Marine	Plum Prune
 <p>18<sup>7</sup>/<sub>8</sub>" x 14<sup>9</sup>/<sub>16</sub>" x 5<sup>7</sup>/<sub>16</sub>"</p>	AGS59	66	\$434. <sup>50</sup> stock	\$654. <sup>50</sup> stock	\$654. <sup>50</sup> stock	\$654. <sup>50</sup>	\$654. <sup>50</sup>	\$654. <sup>50</sup>	\$654. <sup>50</sup>	\$654. <sup>50</sup>
 <p>31<sup>1</sup>/<sub>2</sub>" x 20<sup>1</sup>/<sub>16</sub>" x 5<sup>11</sup>/<sub>16</sub>"</p>	WA80	67	\$1094. <sup>50</sup> stock	—	—	—	—	—	—	—
 <p>39<sup>3</sup>/<sub>8</sub>" x 20<sup>1</sup>/<sub>16</sub>" x 5<sup>11</sup>/<sub>16</sub>"</p>	WA100	68	\$1204. <sup>50</sup> stock	—	—	—	—	—	—	—
 <p>47<sup>1</sup>/<sub>4</sub>" x 20<sup>1</sup>/<sub>16</sub>" x 5<sup>11</sup>/<sub>16</sub>"</p>	WA120D	69	\$1534. <sup>50</sup> stock	—	—	—	—	—	—	—

## Wash basins – Drop-in Lavabos – Encastrés

Photo	Code	Page	Colors and prices (Stock / 90 days) Couleurs et prix (En inventaire / 90 jours)							
			White gloss Blanc lustré	Black matt Noir mat	White matt Blanc mat	Black gloss Noir lustré	Anthracite Anthracite	Lavender blue Bleu lavande	Navy Marine	Plum Prune
 <p>23<sup>5/8</sup>" x 14<sup>15/16</sup>" x 5<sup>1/2</sup>"</p>	BB11	74	\$874. <sup>50</sup> stock	\$1314. <sup>50</sup>	\$1314. <sup>50</sup>	\$1314. <sup>50</sup>	\$1314. <sup>50</sup>	—	—	—
 <p>24" x 19<sup>7/8</sup>" x 7<sup>7/8</sup>"</p>	AR859	75	\$764. <sup>50</sup> stock	—	—	—	—	—	—	—
 <p>26<sup>3/8</sup>" x 12<sup>5/16</sup>" x 7<sup>7/8</sup>"</p>	AR835	76	\$764. <sup>50</sup> stock	—	—	—	—	—	—	—

## Wash basins – Wall hung Lavabos – Suspendus

Photo	Code	Page	Colors and prices (Stock / 90 days) Couleurs et prix (En inventaire / 90 jours)							
			White gloss Blanc lustré	Black matt Noir mat	White matt Blanc mat	Black gloss Noir lustré	Anthracite Anthracite	Lavender blue Bleu lavande	Navy Marine	Plum Prune
 <p>15<sup>3</sup>/<sub>4</sub>" x 17<sup>3</sup>/<sub>4</sub>" x 21<sup>5</sup>/<sub>8</sub>"</p>	BB13	80	\$1754 <sup>.50</sup> stock	\$2524 <sup>.50</sup>	\$2524 <sup>.50</sup>	\$2524 <sup>.50</sup>	\$2524 <sup>.50</sup>	—	—	—
 <p>15<sup>3</sup>/<sub>4</sub>" x 10<sup>5</sup>/<sub>8</sub>" x 3<sup>1</sup>/<sub>8</sub>"</p>	DE15	81	\$324 <sup>.50</sup> stock	\$495	\$495	\$495	\$495	—	—	—
 <p>23<sup>5</sup>/<sub>8</sub>" x 5<sup>1</sup>/<sub>2</sub>" x 2<sup>3</sup>/<sub>8</sub>"</p>	DE16	81	\$434 <sup>.50</sup> stock	\$654 <sup>.50</sup>	\$654 <sup>.50</sup>	\$654 <sup>.50</sup>	\$654 <sup>.50</sup>	—	—	—
 <p>19<sup>11</sup>/<sub>16</sub>" x 22<sup>3</sup>/<sub>4</sub>" x 4<sup>3</sup>/<sub>8</sub>"</p>	FL21	82	\$874 <sup>.50</sup> stock	—	—	—	—	—	—	—
 <p>19<sup>1</sup>/<sub>2</sub>" x 19<sup>1</sup>/<sub>2</sub>" x 4<sup>3</sup>/<sub>8</sub>"</p>	FL24	83	\$874 <sup>.50</sup> stock	—	—	—	—	—	—	—

## Consoles

Photo	Code	Page	Colors and prices (Stock / 90 days) Couleurs et prix (En inventaire / 90 jours)							
			White gloss Blanc lustré	Black matt Noir mat	White matt Blanc mat	Black gloss Noir lustré	Anthracite Anthracite	Lavender blue Bleu lavande	Navy Marine	Plum Prune
 <p>20<sup>1/16</sup>" x 18<sup>1/8</sup>" x 16<sup>1/8</sup>"</p>	AG51CC	87	\$2194 <sup>.50</sup> stock	\$2524 <sup>.50</sup>	\$2524 <sup>.50</sup>	\$2524 <sup>.50</sup>	\$2524 <sup>.50</sup>	\$2524 <sup>.50</sup>	\$2524 <sup>.50</sup>	\$2524 <sup>.50</sup>
 <p>24" x 18<sup>1/8</sup>" x 16<sup>1/8</sup>"</p>	AG61CC	88	\$2524 <sup>.50</sup> stock	\$2964 <sup>.50</sup>	\$2964 <sup>.50</sup>	\$2964 <sup>.50</sup>	\$2964 <sup>.50</sup>	\$2964 <sup>.50</sup>	\$2964 <sup>.50</sup>	\$2964 <sup>.50</sup>
 <p>35<sup>13/16</sup>" x 18<sup>1/8</sup>" x 16<sup>1/8</sup>"</p>	AG91CC	89	\$2964 <sup>.50</sup> stock	\$3404 <sup>.50</sup>	\$3404 <sup>.50</sup>	\$3404 <sup>.50</sup>	\$3404 <sup>.50</sup>	\$3404 <sup>.50</sup>	\$3404 <sup>.50</sup>	\$3404 <sup>.50</sup>

## Consoles





Photo	Code	Page	Colors and prices (Stock / 90 days) Couleurs et prix (En inventaire / 90 jours)							
			White gloss Blanc lustré	Black matt Noir mat	White matt Blanc mat	Black gloss Noir lustré	Anthracite Anthracite	Lavender blue Bleu lavande	Navy Marine	Plum Prune
 <p>35<sup>7</sup>/<sub>16</sub>" x 22<sup>1</sup>/<sub>16</sub>" x 37<sup>3</sup>/<sub>8</sub>"</p>	AR864CG1	90	\$4834 <sup>-50</sup> stock	—	—	—	—	—	—	—
 <p>35<sup>7</sup>/<sub>16</sub>" x 22<sup>1</sup>/<sub>16</sub>" x 36<sup>5</sup>/<sub>8</sub>"</p>	AR8642GB	91	\$2997 <sup>-50</sup> stock	—	—	—	—	—	—	—
 <p>41<sup>5</sup>/<sub>16</sub>" x 22<sup>1</sup>/<sub>16</sub>" x 37<sup>3</sup>/<sub>8</sub>"</p>	AR874CG2	92	\$5258 stock	—	—	—	—	—	—	—
 <p>41<sup>5</sup>/<sub>16</sub>" x 22<sup>1</sup>/<sub>16</sub>" x 36<sup>5</sup>/<sub>8</sub>"</p>	AR8742GB	93	\$3294 <sup>-50</sup> stock	—	—	—	—	—	—	—



## Structures & Countertops Structures et comptoirs

Photo	Code	Page	Colors and prices (Stock) Couleurs et prix (En inventaire)					
			Dark oak Chêne foncé	Grey Ashwood/white matt Frêne gris et blanc mat	Light oak Chêne clair	White matt Blanc mat	Anthracite Anthracite	Chrome Chrome
 41 <sup>3</sup> / <sub>8</sub> " x 22 <sup>7</sup> / <sub>16</sub> " x 31 <sup>1</sup> / <sub>8</sub> "	FM01	96	\$3734. <sup>50</sup> stock	\$3734. <sup>50</sup> stock	—	—	—	—
 71 <sup>3</sup> / <sub>8</sub> " x 22 <sup>7</sup> / <sub>16</sub> " x 31 <sup>1</sup> / <sub>8</sub> "	FM02	97	\$5934. <sup>50</sup> stock	\$5934. <sup>50</sup> stock	—	—	—	—
 47 <sup>1</sup> / <sub>4</sub> " x 18 <sup>3</sup> / <sub>16</sub> " x 3 <sup>15</sup> / <sub>16</sub> "	VIM1	98	—	—	\$1094. <sup>50</sup> stock	—	—	—
 55 <sup>1</sup> / <sub>8</sub> " x 18 <sup>3</sup> / <sub>16</sub> " x 3 <sup>15</sup> / <sub>16</sub> "	VIM2	99	—	—	\$1204. <sup>50</sup> stock	—	—	—
 27 <sup>9</sup> / <sub>16</sub> " x 18 <sup>3</sup> / <sub>16</sub> " x 10 <sup>7</sup> / <sub>16</sub> "	VIM3	100	—	—	—	\$1314. <sup>50</sup> stock	\$1424. <sup>50</sup> stock	—
 18 <sup>3</sup> / <sub>16</sub> " x 3 <sup>3</sup> / <sub>16</sub> " x 5 <sup>1</sup> / <sub>8</sub> "	VIP1	101	—	—	—	—	—	\$467. <sup>50</sup> stock

Mirrors  
Miroirs

Photo	Code	Page	Prices (Stock) Prix (En inventaire)
 <p data-bbox="358 810 431 835">ø27<sup>3/4</sup>"</p>	FS4	104	<p data-bbox="980 653 1062 705"><b>\$1094<sup>.50</sup></b> stock</p>
 <p data-bbox="293 1192 496 1220">47<sup>1/4</sup>" x 15<sup>3/4</sup>" x 1<sup>1/16</sup>"</p>	VIS1	105	<p data-bbox="980 1037 1062 1089"><b>\$544<sup>.50</sup></b> stock</p>
 <p data-bbox="293 1577 496 1604">55<sup>1/8</sup>" x 15<sup>3/4</sup>" x 1<sup>1/16</sup>"</p>	VIS2	106	<p data-bbox="980 1419 1062 1472"><b>\$654<sup>.50</sup></b> stock</p>
 <p data-bbox="293 1961 496 1988">21<sup>11/16</sup>" x 2<sup>3/4</sup>" x 1<sup>3/16</sup>"</p>	VIL1	107	<p data-bbox="980 1801 1062 1854"><b>\$544<sup>.50</sup></b> stock</p>



## AN ITALIAN STORY

Since 1955

### 60 years of Italian history

July 12, 1955. SIMAS was born in Civita Castellana, which even at that time had a high capacity for manual production processes handed down from father to son. Today as yesterday, it is a company made up of people who are committed to developing concrete projects in which everyone works according to their skills. A stock company with 68 shareholders, 109 employees and 150,000 pieces produced annually. Strictly made in Italy, aimed at building, together, trends that are always up-to-date and contemporary and that last over time, the result of consolidated know-how and expertise handed down in the name of work ethic.

## UNE HISTOIRE ITALIENNE

Depuis 1955

### 60 ans d'histoire italienne

12 juillet 1955. SIMAS est créée à Civita Castellana, un territoire qui possédait déjà à cette époque un grand nombre de travailleurs manuels dont le savoir-faire était transmis de père en fils. D'hier à aujourd'hui, cette entreprise a toujours été portée par des gens travaillant à concrétiser des projets auxquels ils apportent leurs diverses compétences.

SIMAS est une société par actions avec 68 associés, 109 salariés et produisant annuellement 150 000 pièces exclusivement fabriquées en Italie. L'entreprise travaille à développer des tendances qui perdurent dans le temps, grâce à son solide savoir-faire et à son expertise transmise et partagée dans un souci d'éthique.





## HAND-MADE IN ITALY

### **A meeting between the Artisan and Industry**

SIMAS prides itself in its dedication to “handcrafted” tradition and, at the same time, to continual evolution, based on two prerogatives: all strictly made in Italy and all strictly manufactured internally from casting and painting to the cooking tunnels and barcode system, with a path that goes from the internal logistics until the distribution.

SIMAS, an emblem of Italian craftsmanship, continues to focus on the original principles: shared opinions, team work, loyal agents, prompt pre-sales and post-sales assistance.

## FAIT À LA MAIN EN ITALIE

### **Une rencontre entre l'artisan et l'industrie**

SIMAS est fière de son attachement à la tradition artisanale tout en étant en constante évolution. De fait, tout est exclusivement fabriqué en Italie et tout est rigoureusement réalisé sur place, du coulage à l'émaillage, en passant par les tunnels de cuisson et le système de traçabilité. Ce cheminement va de la logistique à la distribution.

SIMAS, emblème du savoir-faire italien, est continuellement centrée sur ses principes d'origine: partage de points de vue, travail d'équipe, agents fidélisés ainsi qu'un soutien avant et après-vente efficace.

# CERAMICS

Ceramics, from ancient Greek *κέραμος*, 'kéramos', that is 'clay', 'pottery', is an inorganic, non-metallic material, that may be folded in different shapes at its natural state and that becomes very steady after the firing phase.

Ceramics is usually made of different materials: clays, feldspar, siliceous sands, iron oxides, alumina and quartz; when it is wet clay contains a large amount of water, a minimum of 25%, actually. When clay starts to dry, water evaporates from it and it is important to ensure this process is even, drying slowly, and naturally, as we do in SIMAS: after molding the sanitary ware dry in about 5 days, on a long and slow 'travel' on a 7 km chain passing all along the factory, exploiting the heat coming from the kiln.

Complete drying does not take place until the piece is in the kiln; the last stage that happens during the firing process is vitrification. This is the hardening, tightening and finally the partial glassification of the clay. Vitrification results from fusions or melting of the various components of the clay.

In the field of ceramics sanitary ware two different kind of materials are used: Vitreous China and Fine Fireclay. The production processes (molding, drying, enameling and firing) and the glaze are the same for both materials, the difference is in the characteristics of the ceramics: Vitreous China has a water absorption lower than 0,5% and a heavy pyroclastic shrinkage during the firing process that reaches 1250°C, 2282°F, whereas fireclay has an absorption lower than 9% and a lower pyroclastic shrinkage. These characteristics determine the use of one or another of the two materials (vitreous china for its lower water absorption is used for toilets and bidets and fireclay for objects of large dimensions).

# CÉRAMIQUE

La céramique, du grec antique *κέραμος* ('kéramos' c'est à dire argile, poterie) est un matériau inorganique, non-métallique, qui peut être moulé en formes variées quand il est à l'état naturel et qui devient très dur après le procédé de cuisson.

La céramique est habituellement faite d'un ensemble de matériaux différents : argile, feldspath, sables de silice, oxydes de fer, alumine et quartz. L'argile humide contient une grande quantité d'eau, au minimum 25%, et il est très important que l'eau s'évapore très doucement et naturellement lorsqu'elle sèche, comme nous le faisons chez SIMAS : les pièces moulées sèchent en 5 jours, grâce à un « voyage » sur la chaîne de 7 km qui traverse l'usine entière à la chaleur récupérée du four.

Le procédé de séchage se complète dans le four; la phase finale du procédé de cuisson est la vitrification, c'est-à-dire le durcissement, la contraction et enfin la cristallisation de l'argile. La vitrification est le résultat de la fusion des différents composants de l'argile.

Dans le secteur de la céramique sanitaire, deux différents types de matériaux sont utilisés : la porcelaine vitrifiée et l'argile réfractaire. Les procédés de production (moulage, séchage, vernissage et cuisson) et l'émail sont les mêmes pour les deux, la différence se trouvant dans les caractéristiques de la céramique : la porcelaine vitrifiée a une absorption de l'eau inférieure à 0,5% et une contraction pyroclastique importante pendant la phase de cuisson qui atteint 1250°C (2282°F) alors que l'argile réfractaire a une absorption inférieure à 9% et une contraction pyroclastique moindre.

Ces caractéristiques déterminent l'utilisation de l'un ou l'autre des matériaux (la porcelaine vitrifiée grâce à son absorption inférieure de l'eau est utilisée pour les cuvettes et pour les bidets, alors que l'argile réfractaire profite aux objets de grandes dimensions).



5.1/  
12.7/  
11.1/  
0.08



# AUTHENTICITY AND QUALITY

Excellence through tradition and respect

## Mission 100% Made in Italy

SIMAS proudly boasts the Ceramics of Italy trademark, a 'seal of approval' from Confindustria Ceramica designed to promote and develop the historical, cultural and production heritage of traditional Italian ceramics. The "Ceramics of Italy" trademark is therefore a symbol of Italian excellence, given to a select number of companies. Simas is one of these.

It is certified that SIMAS took part to the project ioCO2MPENSO, thanks to which it has balanced its yearly emissions of CO<sub>2</sub>, by planting and taking care of 200 trees, according to the reforestation program.



Ceramics of Italy

ioCO<sub>2</sub>MPENSO  
New World in Green

# AUTHENTICITÉ ET QUALITÉ

L'excellence par la tradition et le respect

## Objectif: 100 % fabriqué en Italie

SIMAS porte fièrement l'étiquette Ceramics of Italy, un gage de qualité de Confindustria Ceramica valorisant le patrimoine historique, culturel et manufacturier de la céramique italienne traditionnelle. L'étiquette *Ceramics of Italy* est donc un synonyme d'excellence à l'italienne, apanage de quelques entreprises triées sur le volet dont Simas fait partie.

Il est certifié que SIMAS a participé au projet ioCO2MPENSO, grâce auquel l'entreprise a équilibré ses émissions annuelles de CO<sub>2</sub> en plantant et protégeant 200 arbres dans le cadre du programme de reforestation.



# CERTIFICATIONS

The acknowledgement of our efforts

## 'Process' and 'Environmental Management' Certification

SIMAS is CERMET certified, with two important standards: UNI ISO 9001 – 2008 for process quality and UNI ISO 14001 - 2004 for correct environmental management. Regulations that stipulate the requirements for the creation of quality management systems and guarantee respect of the environment.

## UPC Certification

Starting from 2016 some products from SIMAS, which are of particular interest on the international markets (marked inside the catalogue) are certified to be in compliance with the UPC (USA and Canada) proving the compliance with the strict standards existing in those countries for plumbing fixtures and appliances.



# CERTIFICATIONS

La reconnaissance de nos efforts

## Certification de processus et de gestion environnementale

Simas est certifiée CERMET avec deux normes importantes : UNI ISO 9001-2008 pour la qualité du processus et UNI ISO 14001-2004 pour une bonne gestion de l'environnement. Ces normes définissent les caractéristiques nécessaires pour la réalisation de systèmes de gestion de la qualité et elles garantissent le respect des normes environnementales.

## Certification UPC

À partir de 2016, certains produits de SIMAS ayant un intérêt particulier pour les marchés internationaux (identifiés par le logo correspondant à l'intérieur du catalogue) sont certifiés selon la norme UPC (États-Unis et Canada) qui garantit le respect de standards très stricts qui existent dans ces pays en matière d'appareils sanitaires.

# Toilets & Bidets

## Toilettes et bidets

p. **29** Wall hung  
Suspendus



p. **42** **Floormount**  
Au sol



► **Vignoni** #VI04WG - #VI01CWG White gloss/Blanc lustré p.44-45



# SUGGESTED CARRIERS

compatible with Simas toilets

# RÉSERVOIRS ENCASTRÉS SUGGÉRÉS

compatible avec les toilettes Simas

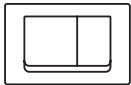

RIA polished chrome  
flush plate included

Plaque de commande RIA  
en chrome poli incluse



Water-saving  
Dual flush system

Système à double chasse  
Économiseur d'eau



Insulation  
Against condensation and noise

Isolé  
Réduit la condensation et le bruit



Ideal for small spaces  
2x4 and 2x6 stud wall installation

Idéal pour les espaces réduits  
Installation entre les montants  
2x4 et 2x6



Adjustable height  
0-5.9" (0-150 mm)

Hauteur ajustable  
0-5.9" (0-150 mm)



Easy clean  
Easy access around and  
beneath the toilet area

Entretien facile  
Accès plus facile aux surfaces  
qui entourent la toilette



For WALLMOUNT toilets  
#601803 \$825

Pour toilettes MURALES  
#601803 \$825



For FLOORMOUNT toilets  
#88487C \$495

Pour toilettes AU SOL  
#88487C \$495



### Additional water savings with Azor Silent

Ecological and silent inlet valve (NF class 1).  
Equipped with a revolutionary delayed refill  
system: starts filling the cistern only when the  
flush valve is closed - allowing additional water  
savings per flush.

### Des économies d'eau supplémentaires avec Azor Silent

Robinet flotteur silencieux (NF classe 1).  
Équipé avec un système révolutionnaire de remplissage différé:  
le réservoir ne se remplit que si la valve de la chasse d'eau est  
fermée, permettant des économies d'eau additionnelles.

\* Visit oli-world.us for full warranty  
\* Visiter oli-world.us pour la garantie complète



**GLOBE**

Color Couleur	Code	Price Prix
Polished chrome Chrome poli	#879454	\$154
Matt chrome Chrome mat	#879455	\$154
White Blanc	#879456	\$110
Black soft-touch Noir «soft touch»	#879457	\$264
Grey soft-touch Gris «soft touch»	#879458	\$264

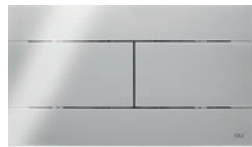

**SLIM/SLIM INOX**

Color Couleur	Code	Price Prix
Polished chrome Chrome poli	#879459	\$154
Matt chrome Chrome mat	#879460	\$154
White Blanc	#879479	\$110
Black soft-touch Noir «soft touch»	#879461	\$264
Grey soft-touch Gris «soft touch»	#879462	\$264
Br. stainless steel Acier inox. brossé	#879463	\$374

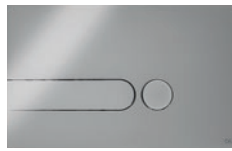

**IPLATE**

Color Couleur	Code	Price Prix
Polished chrome Chrome poli	#879465	\$176
Matt chrome Chrome mat	#879466	\$176
White Blanc	#879464	\$132
Black soft-touch Noir «soft touch»	#879467	\$286

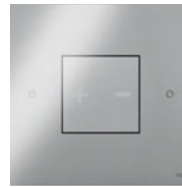

**INO-X 03**

Color Couleur	Code	Price Prix
Polished stainless steel Acier inox. poli	#879474	\$654. <sup>50</sup>
Br. stainless steel Acier inox. brossé	#879475	\$654. <sup>50</sup>



**INO-X 06**

Color Couleur	Code	Price Prix
Polished stainless steel Acier inox. poli	#879476	\$654. <sup>50</sup>
Br. stainless steel Acier inox. brossé	#879477	\$654. <sup>50</sup>



**OCEANIA**

Color Couleur	Code	Price Prix
Br. stainless steel Acier inox. brossé	#879471	\$522. <sup>50</sup>
White glass Verre blanc	#879472	\$522. <sup>50</sup>
Black glass Verre noir	#879473	\$522. <sup>50</sup>



**BLINK**

Color Couleur	Code	Price Prix
Polished stainless steel Acier inox. poli	#879468	\$308
Br. stainless steel Acier inox. brossé	#879469	\$308



**TRUMPET**

Color Couleur	Code	Price Prix
Polished stainless steel Acier inox. poli	#879496	\$825
Br. stainless steel Acier inox. brossé	#879498	\$825
Bronze stainless steel Acier inoxydable en bronze	#879497	\$1072. <sup>50</sup>
Gold stainless steel Acier inox. en or	#879500	\$1072. <sup>50</sup>

## RIMLESS SYSTEM

the superior flushing system

## SYSTÈME SANS REBORD

le système de chasse d'eau supérieur



High-performance flushing

Cleaner bowl with less residues

Superior hygiene

Easier to clean

Reduced splashing

Chasse d'eau de haute performance

Cuvette plus propre avec moins de résidus

Hygiène supérieure

Plus facile à nettoyer

Éclaboussures réduites

# Toilets & Bidets Toilettes et bidets

## Wall hung Suspendus



### **Bormio**

p.32

### **Vignoni**

p.34

### **Baden Baden**

p.36

### **Flow**

p.38

### **Arcadia**

p.40



► Baden Baden #BB19WM - #BB18CWM White matt/Blanc mat p.36-37





► **Arcadia** #AR843WG - AR851CWG White gloss / Blanc lustré p.40-41



► **Flow** #FL64WM - FL63CWM White matt / Blanc mat p.38-39

# TOILETS – Wall hung

# TOILETTES – Suspendues



Compatible with OLI toilet carrier #601803 (see p.26)  
Compatible avec le réservoir encastré OLI #601803 (voir p.26)



Pending  
En instance



Seat and fixing kit included  
Siège et kit de fixation inclus

## Bormio #BR 18C WG

Stock  
En inventaire

**\$764.50**

WG

White Gloss  
Blanc lustré

### Features Caractéristiques

- Italian porcelain
- Glazed syphon/Hidden fixing
- Soundproofing protection included
- Fixing kit F85 included
- Seat included (quick release, concealed chrome finish soft-closing hinges)
- Rimless system (see p.28)
- 4,5 l / 1,2 gal per flush
- 44 lbs / 20 kg

- Porcelaine italienne
- Siphon émaillé/Fixations cachées
- Protection insonorisée incluse
- Jeu de vis de fixation F85 inclus
- Siège inclus (système de retrait rapide, charnières chromées dissimulées à ouverture silencieuse)
- Système sans rebord (voir p.28)
- 4,5 l / 1,2 gal par chasse d'eau
- 44 lbs / 20 kg

### Technical Specifications\*\* Spécifications techniques\*\*

20<sup>1</sup>/<sub>2</sub>" x 13<sup>3</sup>/<sub>4</sub>" x 10<sup>1</sup>/<sub>4</sub>"  
520 x 350 x 260 mm

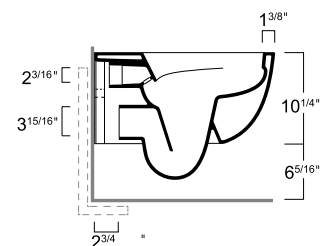
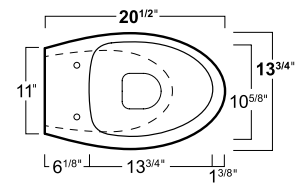

\*\*The manufacturer accepts 1/4" (5 mm) variance  
\*\*Le fabricant accepte une tolérance de 1/4" (5mm)

### Spare parts Pièces de rechange



Toilet seat  
Siège de toilette

**BR 006 WG**

▶ Stock  
En inventaire

**\$363**



Fixing kit  
Jeu de vis de fixation

**F85**

▶ Stock  
En inventaire

**\$93.50**

# BIDETS – Wall hung

# BIDETS – Suspendus



Compatible with OLI bidet carrier #136078 – \$650  
Compatible avec le réservoir encastré OLI #136078 – \$650

Fixing kit included  
Kit de fixation inclus

## Bormio #BR 19 WG

Stock  
En inventaire

**\$654.50**

WG

White Gloss  
Blanc lustré

### Features Caractéristiques

- Italian porcelain
- Single faucet hole
- With overflow
- Hidden fixing
- Soundproofing protection included
- Fixing kit F85 included
- 41.9 lbs / 19 kg

- Porcelaine italienne
- Monotrou
- Avec trop plein
- Fixations cachées
- Protection insonorisée incluse
- Jeu de vis de fixation F85 inclus
- 41.9 lbs / 19 kg

### Technical Specifications\*\* Spécifications techniques\*\*

**20<sup>1</sup>/<sub>2</sub>" x 13<sup>3</sup>/<sub>4</sub>" x 10<sup>1</sup>/<sub>4</sub>"**  
**520 x 350 x 260 mm**

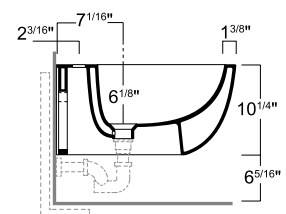
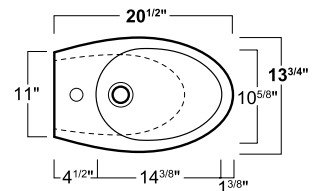

\*\*The manufacturer accepts 1/4" (5 mm) variance  
\*\*Le fabricant accepte une tolérance de 1/4" (5mm)

Spare parts  
Pièces de rechange



Fixing kit  
Jeu de vis de fixation

**F85**

▶ Stock  
En inventaire

**\$93.50**

# TOILETS – Wall hung TOILETTES – Suspendues



Compatible with OLI toilet carrier #601803 (see p.26)  
Compatible avec le réservoir encastré OLI #601803 (voir p.26)



Seat and fixing kit included  
Siège et kit de fixation inclus

## Vignoni #VI 18C \_ \_ \*

**Stock**  
En inventaire

▼ **\$1094.50**      ▼ **\$1754.50**

<b>WG</b>	<b>NM</b>	<b>WM</b>
White Gloss Blanc lustré	Black Matt Noir mat	White Matt Blanc mat

**Special Order – 90 days**  
Commande spéciale – 90 jours **\$1754.50**

<b>NE</b>	<b>AN</b>
Black Gloss Noir lustré	Anthracite Anthracite

### Features Caractéristiques

- Italian porcelain
- Glazed syphon/Hidden fixing
- Soundproofing protection included
- Fixing kit F85 included
- Seat included (quick release, concealed chrome finish soft-closing hinges)
- Rimless system (see p.28)
- 4,5 l / 1,2 gal per flush
- 50.7 lbs / 23 kg

- Porcelaine italienne
- Siphon émaillé/Fixations cachées
- Protection insonorisée incluse
- Jeu de vis de fixation F85 inclus
- Siège inclus (système de retrait rapide, charnières chromées dissimulées à ouverture silencieuse)
- Système sans rebord (voir p.28)
- 4,5 l / 1,2 gal par chasse d'eau
- 50.7 lbs / 23 kg

### Technical Specifications\*\* Spécifications techniques\*\*

**22<sup>1</sup>/<sub>16</sub>" x 14<sup>3</sup>/<sub>8</sub>" x 13<sup>1</sup>/<sub>2</sub>"**  
**560 x 365 x 340 mm**

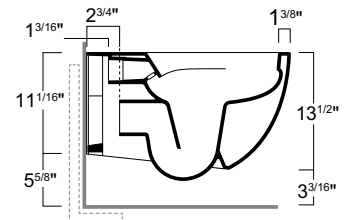
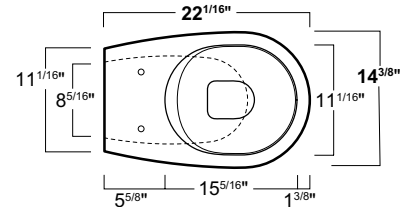

\* 2-letter color code MUST be specified at the end of toilet code ( \_ \_ )  
\* Le code couleur de 2 lettres DOIT être ajouté à la fin du code de la toilette ( \_ \_ )

\*\*The manufacturer accepts 1/4" (5 mm) variance  
\*\*Le fabricant accepte une tolérance de 1/4" (5mm)

<p><b>Spare parts</b> Pièces de rechange</p> 	<p><b>Toilet seat</b> Siège de toilette</p> <p>▶ White Gloss Blanc lustré</p> <p>▶ Other colors Autres couleurs</p>	<p><b>VI 004 _ _ *</b></p> <p><b>\$401.50</b></p> <p><b>\$605.00</b></p>	 <p><b>Fixing kit</b> Jeu de vis de fixation</p> <p>▶ Stock En inventaire</p>	<p><b>F85</b></p> <p><b>\$93.50</b></p>
--	---	--	--	---

# BIDETS – Wall hung

# BIDETS – Suspendus



Compatible with OLI bidet carrier #136078 – \$650  
Compatible avec le réservoir encastré OLI #136078 – \$650

Fixing kit included  
Kit de fixation inclus

## Vignoni #VI 19 \_ \_ \*

### Stock En inventaire

▼ \$874.50

▼ \$1314.50

WG

White Gloss  
Blanc lustré

NM

Black Matt  
Noir mat

WM

White Matt  
Blanc mat

### Special Order – 90 days

Commande spéciale – 90 jours **\$1314.50**

NE

Black Gloss  
Noir lustré

AN

Anthracite  
Anthracite

### Features Caractéristiques

- Italian porcelain
- Single faucet hole
- With overflow
- Hidden fixing
- Soundproofing protection included
- Fixing kit F85 included
- 39.5 lbs / 18 kg

- Porcelaine italienne
- Monotrou
- Avec trop plein
- Fixations cachées
- Protection insonorisée incluse
- Jeu de vis de fixation F85 inclus
- 39.5 lbs / 18 kg

### Technical Specifications\*\* Spécifications techniques\*\*

22<sup>1</sup>/<sub>16</sub>" x 14<sup>3</sup>/<sub>8</sub>" x 13<sup>1</sup>/<sub>2</sub>"  
560 x 365 x 340 mm

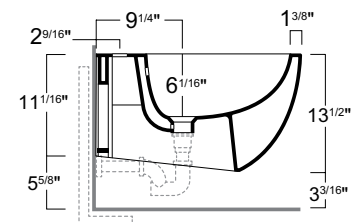
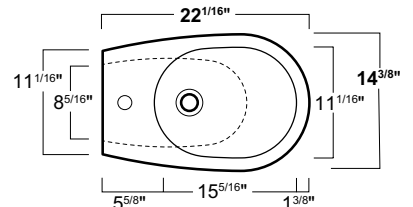

\* 2-letter color code MUST be specified at the end of bidet code ( \_ \_ )  
\* Le code couleur de 2 lettres DOIT être ajouté à la fin du code du bidet ( \_ \_ )

\*\*The manufacturer accepts 1/4" (5 mm) variance  
\*\*Le fabricant accepte une tolérance de 1/4" (5mm)

### Spare parts Pièces de rechange



Fixing kit  
Jeu de vis de fixation

**F85**

▶ Stock  
En inventaire

**\$93.50**

# TOILETS – Wall hung

# TOILETTES – Suspendues



Compatible with OLI toilet carrier #601803 (see p.26)  
Compatible avec le réservoir encastré OLI #601803 (voir p.26)



Pending  
En instance



Seat and fixing kit included  
Siège et kit de fixation inclus

## Baden Baden #BB 18C \_ \_ \*

**Stock**  
En inventaire **\$1424.50**

**WG**  
White Gloss  
Blanc lustré

**Special Order – 90 days**  
Commande spéciale – 90 jours **\$2194.50**

**WM** White Matt / Blanc mat  
**NM** Black Matt / Noir mat  
**NE** Black Gloss / Noir lustré  
**AN** Anthracite / Anthracite

### Features Caractéristiques

- Italian porcelain
- Glazed syphon/Hidden fixing
- Soundproofing protection included
- Fixing kit F85 included
- Seat included (quick release, concealed chrome finish soft-closing hinges)
- Rimless system (see p.28)
- 4,5 l / 1,2 gal per flush
- 39.9 lbs / 18.1 kg

- Porcelaine italienne
- Siphon émaillé/Fixations cachées
- Protection insonorisée incluse
- Jeu de vis de fixation F85 inclus
- Siège inclus (système de retrait rapide, charnières chromées dissimulées à ouverture silencieuse)
- Système sans rebord (voir p.28)
- 4,5 l / 1,2 gal par chasse d'eau
- 39.9 lbs / 18.1 kg

### Technical Specifications\*\* Spécifications techniques\*\*

**22<sup>1</sup>/<sub>16</sub>" x 14<sup>3</sup>/<sub>16</sub>" x 12<sup>3</sup>/<sub>16</sub>"**  
**560 x 360 x 310 mm**

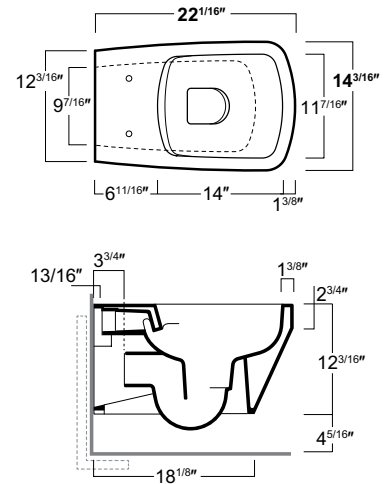

\* 2-letter color code MUST be specified at the end of toilet code ( \_ \_ )  
\* Le code couleur de 2 lettres DOIT être ajouté à la fin du code de la toilette ( \_ \_ )

\*\*The manufacturer accepts 1/4" (5 mm) variance  
\*\*Le fabricant accepte une tolérance de 1/4" (5mm)

<b>Spare parts</b> Pièces de rechange		<b>Toilet seat</b> Siège de toilette <b>BB 004 _ _ *</b>		<b>Fixing kit</b> Jeu de vis de fixation <b>F85</b>
		White Gloss Blanc lustré <b>\$401.50</b> Other colors Autres couleurs <b>\$605.00</b>		Stock En inventaire <b>\$93.50</b>

# BIDETS – Wall hung

# BIDETS – Suspendus



Compatible with OLI bidet carrier #136078 – \$650  
Compatible avec le réservoir encastré OLI #136078 – \$650

Fixing kit included  
Kit de fixation inclus

## Baden Baden #BB 19 \_ \_ \*

Stock  
En inventaire

**\$1094.50**

WG

White Gloss  
Blanc lustré

Special Order – 90 days

Commande spéciale – 90 jours **\$1754.50**

WM

White Matt  
Blanc mat

NM

Black Matt  
Noir mat

NE

Black Gloss  
Noir lustré

AN

Anthracite  
Anthracite

Features  
Caractéristiques

- Italian porcelain
- Single faucet hole
- With overflow
- Hidden fixing
- Soundproofing protection included
- Fixing kit F85 included
- 28.5 lbs / 13 kg

- Porcelaine italienne
- Monotrou
- Avec trop plein
- Fixations cachées
- Protection insonorisée incluse
- Jeu de vis de fixation F85 inclus
- 28.5 lbs / 13 kg

Technical Specifications\*\*  
Spécifications techniques\*\*

**22<sup>1</sup>/<sub>16</sub>" x 14<sup>3</sup>/<sub>16</sub>" x 12<sup>3</sup>/<sub>16</sub>"**  
**560 x 360 x 310 mm**

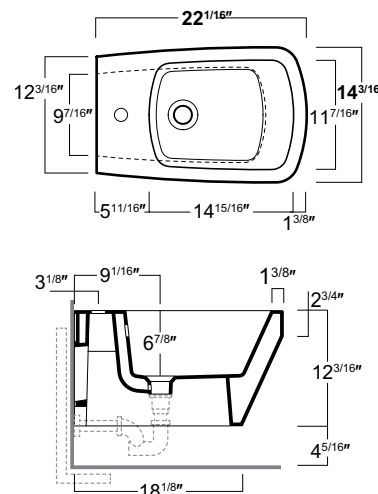

\*\*The manufacturer accepts 1/4" (5 mm) variance  
\*\*Le fabricant accepte une tolérance de 1/4" (5mm)

\* 2-letter color code MUST be specified at the end of bidet code ( \_ \_ )  
\* Le code couleur de 2 lettres DOIT être ajouté à la fin du code du bidet ( \_ \_ )

Spare parts  
Pièces de rechange



Fixing kit  
Jeu de vis de fixation

**F85**

▶ Stock  
En inventaire

**\$93.50**

# TOILETS – Wall hung TOILETTES – Suspendues



Compatible with OLI toilet carrier #601803 (see p.26)  
Compatible avec le réservoir encastré OLI #601803 (voir p.26)



Seat and fixing kit included  
Siège et kit de fixation inclus

## Flow #FL 63C \_ \_ \*

Stock  
En inventaire

**\$1424.50**

WG

White Gloss  
Blanc lustré

Special Order – 90 days

Commande spéciale – 90 jours **\$2194.50**

WM

White Matt  
Blanc mat

NE

Black Gloss  
Noir lustré

AN

Anthracite  
Anthracite

### Features Caractéristiques

- Italian porcelain
- Glazed syphon/Hidden fixing
- Soundproofing protection included
- Fixing kit F85 included
- Seat included (quick release, concealed chrome finish soft-closing hinges)
- Rimless system (see p.28)
- 4,5 l / 1,2 gal per flush
- 50.3 lbs / 22.8 kg

- Porcelaine italienne
- Siphon émaillé/Fixations cachées
- Protection insonorisée incluse
- Jeu de vis de fixation F85 inclus
- Siège inclus (système de retrait rapide, charnières chromées dissimulées à ouverture silencieuse)
- Système sans rebord (voir p.28)
- 4,5 l / 1,2 gal par chasse d'eau
- 50.3 lbs / 22.8 kg

### Technical Specifications\*\* Spécifications techniques\*\*

**19 11/16" x 14 1/4" x 9 1/16"**  
**500 x 360 x 230 mm**

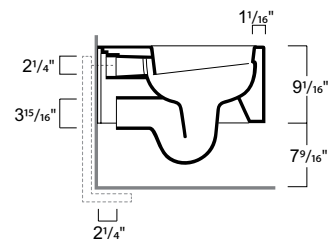
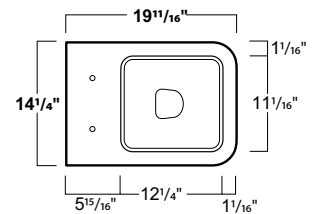

\* 2-letter color code MUST be specified at the end of toilet code ( \_ \_ )

\* Le code couleur de 2 lettres DOIT être ajouté à la fin du code de la toilette ( \_ \_ )

\*\*The manufacturer accepts 1/4" (5 mm) variance

\*\*Le fabricant accepte une tolérance de 1/4" (5mm)

### Spare parts Pièces de rechange



Toilet seat  
Siège de toilette

**FL 28 \_ \_ \***

▶ White Gloss  
Blanc lustré

**\$374.00**

▶ Other colors  
Autres couleurs

**\$522.50**



Fixing kit  
Jeu de vis de fixation

**F85**

▶ Stock  
En inventaire

**\$93.50**



# BIDETS – Wall hung

# BIDETS – Suspendus



Compatible with OLI bidet carrier #136078 – \$650  
Compatible avec le réservoir encastré OLI #136078 – \$650

Fixing kit included  
Kit de fixation inclus

## Flow #FL 64 \_ \_ \*

Stock  
En inventaire

**\$1094.50**

**WG**

White Gloss  
Blanc lustré

Special Order – 90 days

Commande spéciale – 90 jours **\$1754.50**

**WM**

White Matt  
Blanc mat

**NE**

Black Gloss  
Noir lustré

**AN**

Anthracite  
Anthracite

### Features Caractéristiques

- Italian porcelain
- Single faucet hole
- With overflow
- Hidden fixing
- Soundproofing protection included
- Fixing kit F85 included
- 35 lbs / 16 kg

- Porcelaine italienne
- Monotrou
- Avec trop plein
- Fixations cachées
- Protection insonorisée incluse
- Jeu de vis de fixation F85 inclus
- 35 lbs / 16 kg

### Technical Specifications\*\* Spécifications techniques\*\*

**19<sup>11/16</sup>" x 14<sup>1/4</sup>" x 9<sup>1/16</sup>"**  
**500 x 360 x 230 mm**

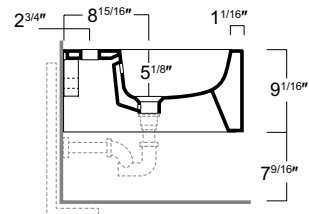
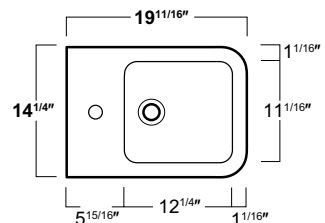

\* 2-letter color code MUST be specified at the end of bidet code ( \_ \_ )  
\* Le code couleur de 2 lettres DOIT être ajouté à la fin du code du bidet ( \_ \_ )

\*\*The manufacturer accepts 1/4" (5 mm) variance  
\*\*Le fabricant accepte une tolérance de 1/4" (5mm)

### Spare parts Pièces de rechange

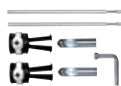

Fixing kit  
Jeu de vis de fixation

**F85**

▶ Stock  
En inventaire

**\$93.50**

# TOILETS – Wall hung TOILETTES – Suspendues



Compatible with OLI toilet carrier #601803 (see p.26)  
Compatible avec le réservoir encastré OLI #601803 (voir p.26)



Seat included  
Siège inclus

## Arcadia #AR 841C WG

Stock  
En inventaire

**\$1424.50**

WG

White Gloss  
Blanc lustré

### Features Caractéristiques

- Italian porcelain
- Glazed syphon
- Soundproofing protection included
- Fixing kit not included
- Seat included (quick release, chrome finish soft-closing hinges)
- Rimless system (see p.28)
- 4,5 l / 1,2 gal per flush
- 44 lbs / 20 kg

### Technical Specifications\*\* Spécifications techniques\*\*

20<sup>1</sup>/<sub>16</sub>" x 14<sup>3</sup>/<sub>8</sub>" x 11<sup>13</sup>/<sub>16</sub>"  
510 x 365 x 300 mm

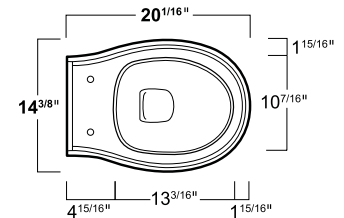

## Arcadia #AR 851C WG

Dark wood seat Siège en bois foncé

Stock  
En inventaire

**\$1644.50**

WG

White Gloss  
Blanc lustré



- Porcelaine italienne
- Siphon émaillé
- Protection insonorisée incluse
- Jeu de vis de fixation non inclus
- Siège inclus (système de retrait rapide, charnières chromées à ouverture silencieuse)
- Système sans rebord (voir p.28)
- 4,5 l / 1,2 gal par chasse d'eau
- 44 lbs / 20 kg

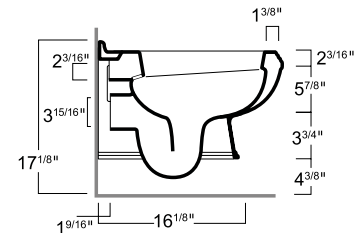

\*\*The manufacturer accepts 1/4" (5 mm) variance  
\*\*Le fabricant accepte une tolérance de 1/4" (5mm)

### Spare parts Pièces de rechange



Toilet seat  
Siège de toilette

▶ Stock  
En inventaire

**AR 006**

**\$489.50**



Toilet seat  
Siège de toilette

▶ Stock  
En inventaire

**AR 008**

**\$660**

# BIDETS – Wall hung

# BIDETS – Suspendus



Compatible with OLI bidet  
carrier #136078 – \$650  
Compatible avec le réservoir  
encastré OLI #136078 – \$650

## Arcadia #AR 843 WG

Stock  
En inventaire

**\$984.50**

WG

White Gloss  
Blanc lustré

### Features Caractéristiques

- Italian porcelain
- Single faucet hole
- With overflow
- Fixing kit not included
- Soundproofing protection included
- 37.5 lbs / 17 kg

- Porcelaine italienne
- Monotrou
- Avec trop plein
- Jeu de vis de fixation non inclus
- Protection insonorisée incluse
- 37.5 lbs / 17 kg

### Technical Specifications\*\* Spécifications techniques\*\*

**20<sup>7</sup>/<sub>8</sub>" x 14<sup>3</sup>/<sub>8</sub>" x 11<sup>13</sup>/<sub>16</sub>"**  
**530 x 365 x 300 mm**

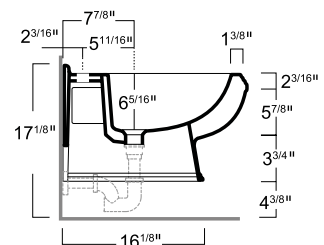
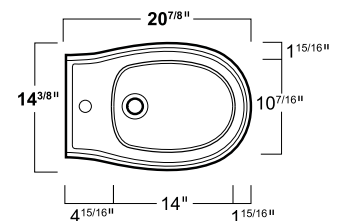

\*\*The manufacturer accepts 1/4" (5 mm) variance  
\*\*Le fabricant accepte une tolérance de 1/4" (5mm)



# Toilets & Bidets Toilettes et bidets

## Floormount Au sol



**Vignoni**  
p.44

# TOILETS & BIDETS – Floormount TOILETTES ET BIDETS – Au sol



Compatible with OLI toilet carrier #88487C (see p.26)  
Compatible avec le réservoir encastré OLI #88487C (voir p.26)



Pending  
En instance



Seat and fixing kit included  
Siège et kit de fixation inclus

## Vignoni #VI 01C \_ \_ \*

Stock  
En inventaire

**\$1424.50**

WG

White Gloss  
Blanc lustré

Special Order – 90 days

Commande spéciale – 90 jours **\$2084.50**

WM

White Matt  
Blanc mat

NM

Black Matt  
Noir mat

NE

Black Gloss  
Noir lustré

AN

Anthracite  
Anthracite

Pan connector required (see p.45)  
Coude d'évacuation requis (voir p.45)

### Features Caractéristiques

- Italian porcelain
- Glazed syphon/Hidden fixing
- Fixing kit F88 included
- Seat included (quick release, concealed chrome finish soft-closing hinges)
- Rimless system (see p.28)
- 4,5 l / 1,2 gal per flush
- 58.4 lbs / 26.5 kg

- Porcelaine italienne
- Siphon émaillé/Fixations cachées
- Jeu de vis de fixation F88 inclus
- Siège inclus (système de retrait rapide, charnières chromées dissimulées à ouverture silencieuse)
- Système sans rebord (voir p.28)
- 4,5 l / 1,2 gal par chasse d'eau
- 58.4 lbs / 26.5 kg

### Technical Specifications\*\* Spécifications techniques\*\*

**22<sup>1</sup>/<sub>16</sub>" x 14<sup>3</sup>/<sub>8</sub>" x 16<sup>9</sup>/<sub>16</sub>"**  
**560 x 365 x 420 mm**

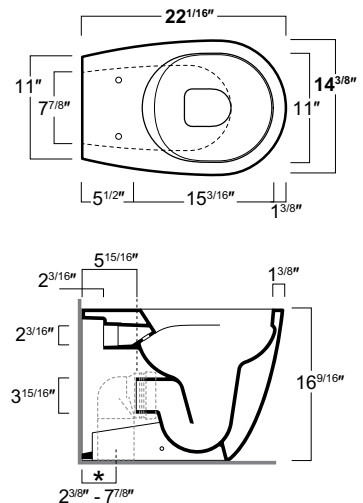

\* 2-letter color code MUST be specified at the end of toilet code ( \_ \_ )

\* Le code couleur de 2 lettres DOIT être ajouté à la fin du code de la toilette ( \_ \_ )

\*\*The manufacturer accepts 1/4" (5 mm) variance

\*\*Le fabricant accepte une tolérance de 1/4" (5mm)

### Spare parts Pièces de rechange



Toilet seat  
Siège de toilette

VI 004 \_ \_ \*

▶ White Gloss  
Blanc lustré

**\$401.50**

▶ Other colors  
Autres couleurs

**\$605.00**



Fixing kit  
Jeu de vis de fixation

**F88**

▶ Stock  
En inventaire

**\$33**

# PAN CONNECTOR – For floormount toilet COUDE D'ÉVACUATION – Pour toilette au sol

The VIGNONI floormount toilet requires the use of a pan connector.

Its installation is easy, as it is fitted into the back of the toilet pan and connected to the toilet waste pipe.

La toilette au sol VIGNONI nécessite l'utilisation d'un coude pour l'évacuation au sol.

Son installation est simple puisqu'il est ajusté à l'arrière de la toilette et raccordé à la bride de toilette.



Vignoni #CT 01

Pan connector – Type L  
Coude d'évacuation – Type L

\$77.00

### Features Caractéristiques

- WC rough can be centered between 60mm and 200mm from the finished wall
- Can be adjusted by cutting until 100mm
- Outlet Ø from 90mm to 100mm
- Usually used in the range 60/140mm from the wall

- La bride de la toilette peut être centrée entre 60mm et 200mm du mur de finition
- Peut être ajusté en coupant jusqu'à 100mm
- Sortie : ø de 90mm à 100mm
- Habituellement utilisé dans une intervalle de 60mm à 140mm du mur

### Technical Specifications\*\* Spécifications techniques\*\*

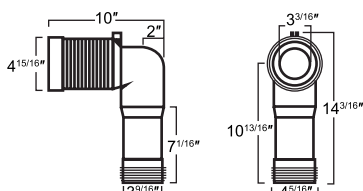

Vignoni #CT 02

Pan connector  
Coude d'évacuation

\$49.50

### Features Caractéristiques

- Requires the WC rough be installed **AT** 200mm from the finished wall
- Outlet Ø 100mm
- Metal fixing set included

- La bride de la toilette **DOIT** être installée à 200mm du mur de finition
- Sortie : ø de 100mm
- Jeu de fixation en métal inclus

### Technical Specifications\*\* Spécifications techniques\*\*

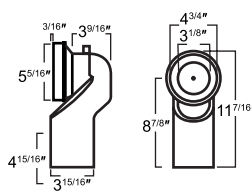

Vignoni #CT 03

Pan connector – Type S  
Coude d'évacuation – Type S

\$77.00

### Features Caractéristiques

- WC rough can be centered between 170mm and 210mm from the finished wall
- Can be adjusted by cutting until 100mm
- Outlet Ø 100mm
- Usually used in the range 150/230mm from the wall

- La bride de la toilette peut être centrée entre 170mm et 210mm du mur de finition
- Peut être ajusté en coupant jusqu'à 100mm
- Sortie : ø de 100mm
- Habituellement utilisé dans une intervalle de 150mm à 230mm du mur

### Technical Specifications\*\* Spécifications techniques\*\*

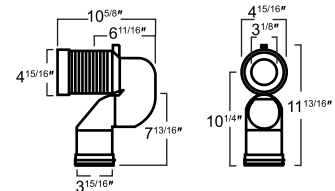

\*\*The manufacturer accepts 1/4" (5 mm) variance  
\*\*Le fabricant accepte une tolérance de 1/4" (5mm)

# TOILETS & BIDETS – Floormount

# TOILETTES ET BIDETS – Au sol



**Fixing kit included**  
Kit de fixation inclus

Vignoni **#VI 04** \_ \_ \*

**Stock**  
En inventaire

**\$1094.50**

**WG**

White Gloss  
Blanc lustré

**Special Order – 90 days**

**Commande spéciale – 90 jours \$1754.50**

**WM**

White Matt  
Blanc mat

**NM**

Black Matt  
Noir mat

**NE**

Black Gloss  
Noir lustré

**AN**

Anthracite  
Anthracite

**Features**  
Caractéristiques

- Italian porcelain
- Single faucet hole
- With overflow
- Hidden fixing
- Fixing kit F88 included
- 51.8 lbs / 23.5 kg

- Porcelaine italienne
- Monotrou
- Avec trop plein
- Fixations cachées
- Jeu de vis de fixation F88 inclus
- 51.8 lbs / 23.5 kg

**Technical Specifications\*\***  
Spécifications techniques\*\*

**22<sup>1</sup>/<sub>16</sub>" x 14<sup>3</sup>/<sub>8</sub>" x 16<sup>9</sup>/<sub>16</sub>"**  
**560 x 365 x 420 mm**

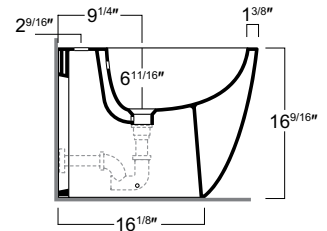
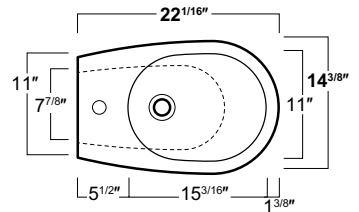

\* 2-letter color code MUST be specified at the end of bidet code ( \_ \_ )  
\* Le code couleur de 2 lettres DOIT être ajouté à la fin du code du bidet ( \_ \_ )

\*\*The manufacturer accepts 1/4" (5 mm) variance  
\*\*Le fabricant accepte une tolérance de 1/4" (5mm)

**Spare parts**  
Pièces de rechange



**Fixing kit**  
Jeu de vis de fixation

**F88**

▶ **Stock**  
En inventaire

**\$33**



# Wash basins Lavabos

p. **48** **Countertop**  
Sur comptoir



p. **64** **Under counter & vanity top**  
Sous comptoir et  
dessus de vanité



p. **70** **Drop-in**  
Encastrés



p. **77** **Wall hung**  
Suspendus





# Wash basins Lavabos

## Countertop Sur comptoir



**Sharp**

p.55

**Wave**

p.62

**Agile**

p.63





► Sharp #SH02NM Black matt/Noir mat p.56



► Sharp #SH07PR Plum/Prune p.59



► Wave #WA02WM White matt/Blanc mat p.62



► Sharp #SH08NM Black matt/Noir mat p.60



► Sharp #SH01PE Lavender blue/Bleu lavande p.55



# WASH BASINS – Countertop

## LAVABOS – Sur comptoir



Sharp **#SH 01** \_ \_ \*

**Stock**  
En inventaire

**\$654.50**

**WG**

White Gloss  
Blanc lustré

**Special Order – 90 days**

Commande spéciale – 90 jours

**\$984.50**

**WM**

White Matt  
Blanc mat

**NM**

Black Matt  
Noir mat

**NE**

Black Gloss  
Noir lustré

**AN**

Anthracite  
Anthracite

**PE**

Lavender Blue  
Bleu lavande

**NA**

Navy  
Marine

**PR**

Plum  
Prune

**Features**  
Caractéristiques

- Italian porcelain
- Drain not included
- No overflow
- 21 lbs / 9.5 kg

- Porcelaine italienne
- Drain non inclus
- Sans trop-plein
- 21 lbs / 9.5 kg

**Technical Specifications\*\***  
Spécifications techniques\*\*

**ø 19<sup>11/16</sup>" x 5<sup>3/4</sup>"**  
**ø 500 x 145 mm**

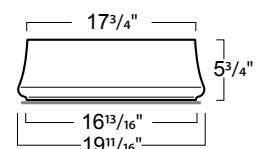
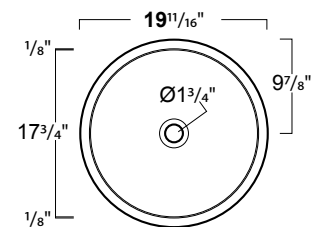

\* 2-letter color code MUST be specified at the end of basin code ( \_ \_ )  
\* Le code couleur de 2 lettres DOIT être ajouté à la fin du code du lavabo ( \_ \_ )

\*\*The manufacturer accepts 1/4" (5 mm) variance  
\*\*Le fabricant accepte une tolérance de 1/4" (5mm)

# WASH BASINS – Countertop

## LAVABOS – Sur comptoir



### Sharp #SH 02 \_ \_ \*

#### Stock En inventaire

<div style="background-color: white; border: 1px solid black; border-radius: 10px; width: 40px; height: 40px; margin: 0 auto; display: flex; align-items: center; justify-content: center;"> <b>WG</b> </div> <p style="font-size: 8px; margin-top: 2px;">White Gloss Blanc lustré</p>	<span style="font-size: 24px; color: teal;">▶</span> <b>\$654.50</b>	<div style="background-color: black; color: white; border-radius: 10px; width: 40px; height: 40px; margin: 0 auto; display: flex; align-items: center; justify-content: center;"> <b>NM</b> </div> <p style="font-size: 8px; margin-top: 2px;">Black Matt Noir mat</p>	<span style="font-size: 24px; color: teal;">▶</span> <b>\$984.50</b>
--	--	--	--

#### Special Order – 90 days Commande spéciale – 90 jours **\$984.50**

<div style="background-color: white; border: 1px solid black; border-radius: 10px; width: 40px; height: 40px; margin: 0 auto; display: flex; align-items: center; justify-content: center;"> <b>WM</b> </div> <p style="font-size: 8px; margin-top: 2px;">White Matt Blanc mat</p>	<div style="background-color: black; color: white; border-radius: 10px; width: 40px; height: 40px; margin: 0 auto; display: flex; align-items: center; justify-content: center;"> <b>NE</b> </div> <p style="font-size: 8px; margin-top: 2px;">Black Gloss Noir lustré</p>	<div style="background-color: #333; color: white; border-radius: 10px; width: 40px; height: 40px; margin: 0 auto; display: flex; align-items: center; justify-content: center;"> <b>AN</b> </div> <p style="font-size: 8px; margin-top: 2px;">Anthracite Anthracite</p>
<div style="background-color: #666; color: white; border-radius: 10px; width: 40px; height: 40px; margin: 0 auto; display: flex; align-items: center; justify-content: center;"> <b>PE</b> </div> <p style="font-size: 8px; margin-top: 2px;">Lavender Blue Bleu lavande</p>	<div style="background-color: #003366; color: white; border-radius: 10px; width: 40px; height: 40px; margin: 0 auto; display: flex; align-items: center; justify-content: center;"> <b>NA</b> </div> <p style="font-size: 8px; margin-top: 2px;">Navy Marine</p>	<div style="background-color: #663366; color: white; border-radius: 10px; width: 40px; height: 40px; margin: 0 auto; display: flex; align-items: center; justify-content: center;"> <b>PR</b> </div> <p style="font-size: 8px; margin-top: 2px;">Plum Prune</p>

#### Features Caractéristiques

- Italian porcelain
- Drain not included
- No overflow
- 17.5 lbs / 8 kg

- Porcelaine italienne
- Drain non inclus
- Sans trop-plein
- 17.5 lbs / 8 kg

#### Technical Specifications\*\* Spécifications techniques\*\*

**Ø 16<sup>11</sup>/<sub>16</sub>" x 6<sup>3</sup>/<sub>8</sub>"**  
**Ø 420 x 160 mm**

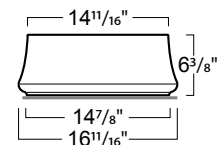
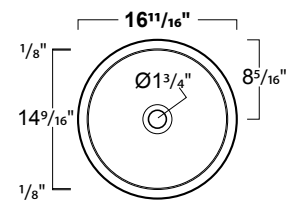

\* 2-letter color code MUST be specified at the end of basin code ( \_ \_ )  
\* Le code couleur de 2 lettres DOIT être ajouté à la fin du code du lavabo ( \_ \_ )

\*\*The manufacturer accepts 1/4" (5 mm) variance  
\*\*Le fabricant accepte une tolérance de 1/4" (5mm)

# WASH BASINS – Countertop

## LAVABOS – Sur comptoir



Sharp **#SH 03** \_ \_ \*

**Stock**  
En inventaire

**\$654.50**

**WG**

White Gloss  
Blanc lustré

**Features**  
Caractéristiques

- Italian porcelain
- Single faucet hole
- Drain not included
- With overflow
- 20 lbs / 9 kg

- Porcelaine italienne
- Monotrou
- Drain non inclus
- Avec trop-plein
- 20 lbs / 9 kg

**Technical Specifications\*\***  
Spécifications techniques\*\*

**ø 16<sup>11/16</sup> " x 6<sup>3/8</sup> "**  
**ø 420 x 160 mm**

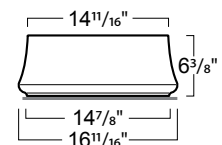
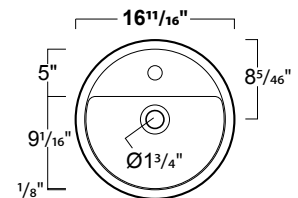

**Special Order – 90 days**

Commande spéciale – 90 jours

**\$984.50**

**WM**

White Matt  
Blanc mat

**NM**

Black Matt  
Noir mat

**NE**

Black Gloss  
Noir lustré

**AN**

Anthracite  
Anthracite

**PE**

Lavender Blue  
Bleu lavande

**NA**

Navy  
Marine

**PR**

Plum  
Prune

\* 2-letter color code MUST be specified at the end of basin code ( \_ \_ )

\* Le code couleur de 2 lettres DOIT être ajouté à la fin du code du lavabo ( \_ \_ )

\*\*The manufacturer accepts 1/4" (5 mm) variance

\*\*Le fabricant accepte une tolérance de 1/4" (5mm)

# WASH BASINS – Countertop

## LAVABOS – Sur comptoir



Sharp **#SH 06** \_ \_ \*

### Stock En inventaire

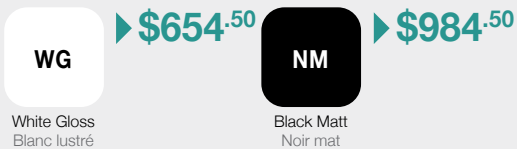

### Special Order – 90 days Commande spéciale – 90 jours **\$984.50**

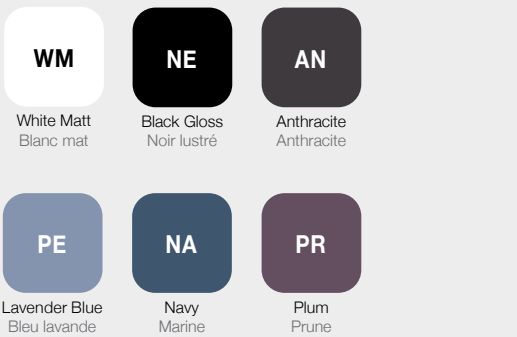

### Features Caractéristiques

- Italian porcelain
- Drain not included
- No overflow
- 22 lbs / 10 kg

- Porcelaine italienne
- Drain non inclus
- Sans trop-plein
- 22 lbs / 10 kg

### Technical Specifications\*\* Spécifications techniques\*\*

**16<sup>11/16</sup>" x 16<sup>11/16</sup>" x 6<sup>3/8</sup>"**  
**420 x 420 x 160 mm**

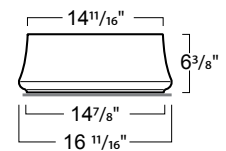
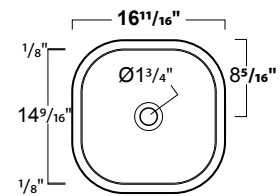

# WASH BASINS – Countertop

## LAVABOS – Sur comptoir



Sharp **#SH 07** \_ \_ \*

**Stock**  
En inventaire

**\$654.50**

**WG**

White Gloss  
Blanc lustré

**Special Order – 90 days**

Commande spéciale – 90 jours

**\$984.50**

**WM**

White Matt  
Blanc mat

**NM**

Black Matt  
Noir mat

**NE**

Black Gloss  
Noir lustré

**AN**

Anthracite  
Anthracite

**PE**

Lavender Blue  
Bleu lavande

**NA**

Navy  
Marine

**PR**

Plum  
Prune

**Features**  
Caractéristiques

- Italian porcelain
- Single faucet hole
- Drain not included
- With overflow
- 24 lbs / 11 kg

- Porcelaine italienne
- Monotrou
- Drain non inclus
- Avec trop-plein
- 24 lbs / 11 kg

**Technical Specifications\*\***  
Spécifications techniques\*\*

**16<sup>11</sup>/<sub>16</sub>" x 16<sup>11</sup>/<sub>16</sub>" x 6<sup>3</sup>/<sub>8</sub>"**  
**420 x 420 x 160 mm**

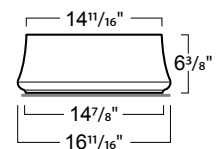
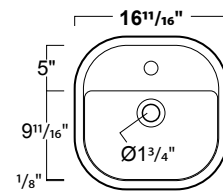

\* 2-letter color code MUST be specified at the end of basin code ( \_ \_ )  
\* Le code couleur de 2 lettres DOIT être ajouté à la fin du code du lavabo ( \_ \_ )

\*\*The manufacturer accepts 1/4" (5 mm) variance  
\*\*Le fabricant accepte une tolérance de 1/4" (5mm)

# WASH BASINS – Countertop LAVABOS – Sur comptoir



Sharp **#SH 08** \_ \_ \*

**Stock**  
En inventaire

**\$764.50**

**WG**

White Gloss  
Blanc lustré

**Special Order – 90 days**

Commande spéciale – 90 jours **\$1094.50**

**WM**

White Matt  
Blanc mat

**NM**

Black Matt  
Noir mat

**NE**

Black Gloss  
Noir lustré

**AN**

Anthracite  
Anthracite

**PE**

Lavender Blue  
Bleu lavande

**NA**

Navy  
Marine

**PR**

Plum  
Prune

**Features**  
Caractéristiques

- Italian porcelain
- Drain not included
- No overflow
- 28.5 lbs / 13 kg

- Porcelaine italienne
- Drain non inclus
- Sans trop-plein
- 28.5 lbs / 13 kg

**Technical Specifications\*\***  
Spécifications techniques\*\*

**23<sup>13</sup>/<sub>16</sub>" x 16<sup>11</sup>/<sub>16</sub>" x 6<sup>3</sup>/<sub>8</sub>"**  
**600 x 420 x 160 mm**

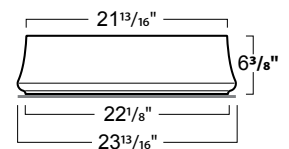
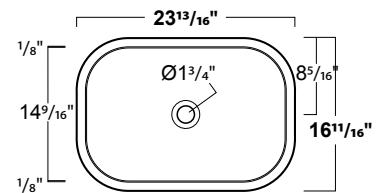

# WASH BASINS – Countertop LAVABOS – Sur comptoir



Sharp **#SH 09** \_ \_ \*

**Stock**  
En inventaire

**\$764.50**

**WG**

White Gloss  
Blanc lustré

**Special Order – 90 days**

Commande spéciale – 90 jours **\$1094.50**

**WM**

White Matt  
Blanc mat

**NM**

Black Matt  
Noir mat

**NE**

Black Gloss  
Noir lustré

**AN**

Anthracite  
Anthracite

**PE**

Lavender Blue  
Bleu lavande

**NA**

Navy  
Marine

**PR**

Plum  
Prune

**Features**  
Caractéristiques

- Italian porcelain
- Single faucet hole
- Drain not included
- With overflow
- 28.5 lbs / 13 kg

- Porcelaine italienne
- Monotrou
- Drain non inclus
- Avec trop-plein
- 28.5 lbs / 13 kg

**Technical Specifications\*\***  
Spécifications techniques\*\*

**23<sup>13</sup>/<sub>16</sub>" x 16<sup>11</sup>/<sub>16</sub>" x 6<sup>3</sup>/<sub>8</sub>"**  
**600 x 420 x 160 mm**

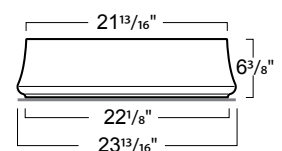
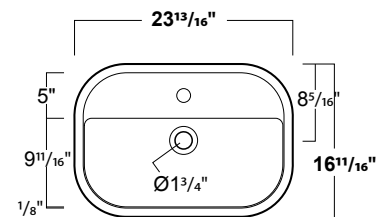

\* 2-letter color code MUST be specified at the end of basin code ( \_ \_ )  
\* Le code couleur de 2 lettres DOIT être ajouté à la fin du code du lavabo ( \_ \_ )

\*\*The manufacturer accepts 1/4" (5 mm) variance  
\*\*Le fabricant accepte une tolérance de 1/4" (5mm)

# WASH BASINS – Countertop

## LAVABOS – Sur comptoir



Pending  
En instance

### Wave #WA 02 \_ \_ \*

**Stock**  
En inventaire **\$874.50**

**WG**

White Gloss  
Blanc lustré

**Special Order – 90 days**  
Commande spéciale – 90 jours **\$1204.50**

<b>WM</b> White Matt Blanc mat	<b>NM</b> Black Matt Noir mat	<b>NE</b> Black Gloss Noir lustré	<b>AN</b> Anthracite Anthracite
<b>PE</b> Lavender Blue Bleu lavande	<b>NA</b> Navy Marine	<b>PR</b> Plum Prune	

#### Features Caractéristiques

- Italian porcelain
- Drain not included
- No overflow
- 23 lbs / 10.5 kg

- Porcelaine italienne
- Drain non inclus
- Sans trop-plein
- 23 lbs / 10.5 kg

#### Technical Specifications\*\* Spécifications techniques\*\*

**23<sup>5/8</sup>" x 16<sup>9/16</sup>" x 6<sup>1/2</sup>"**  
**600 x 420 x 165 mm**

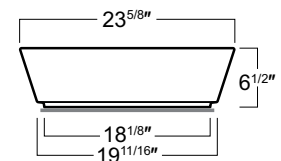
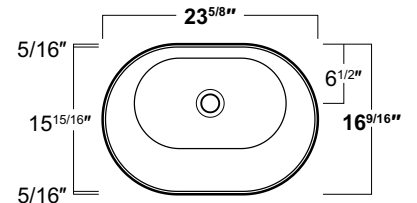

\* 2-letter color code MUST be specified at the end of basin code ( \_ \_ )  
\* Le code couleur de 2 lettres DOIT être ajouté à la fin du code du lavabo ( \_ \_ )

\*\*The manufacturer accepts 1/4" (5 mm) variance  
\*\*Le fabricant accepte une tolérance de 1/4" (5mm)



# WASH BASINS – Countertop

## LAVABOS – Sur comptoir



Agile #AG 60 \_\_ \*

**Stock**  
En inventaire **\$984.50**

**WG**  
White Gloss  
Blanc lustré

**Special Order – 90 days**  
Commande spéciale – 90 jours **\$1375**

<b>WM</b> White Matt Blanc mat	<b>NM</b> Black Matt Noir mat	<b>NE</b> Black Gloss Noir lustré	<b>AN</b> Anthracite Anthracite
<b>PE</b> Lavender Blue Bleu lavande	<b>NA</b> Navy Marine	<b>PR</b> Plum Prune	

### Features Caractéristiques

- Italian porcelain
- Drain not included
- No overflow
- 30.9 lbs / 14 kg

- Porcelaine italienne
- Drain non inclus
- Sans trop-plein
- 30.9 lbs / 14 kg

### Technical Specifications\*\* Spécifications techniques\*\*

**23<sup>5</sup>/<sub>8</sub>" x 15<sup>3</sup>/<sub>4</sub>" x 5<sup>1</sup>/<sub>8</sub>"**  
**600 x 400 x 130 mm**

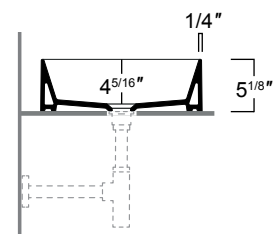
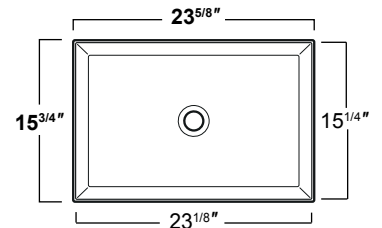

\* 2-letter color code MUST be specified at the end of basin code ( \_\_ )  
\* Le code couleur de 2 lettres DOIT être ajouté à la fin du code du lavabo ( \_\_ )

\*\*The manufacturer accepts 1/4" (5 mm) variance  
\*\*Le fabricant accepte une tolérance de 1/4" (5mm)



► Agile #AGS59WG White gloss/Blanc lustré p.66

# Wash basins

## Lavabos

Under counter & Vanity top  
Sous comptoir et  
dessus de vanité



**Agile**

p.66

**Wave**

p.67

# WASH BASINS – Under counter

## LAVABOS – Sous comptoir



### Agile #AGS 59 \_\_ \*

**Stock**  
En inventaire

▼ **\$434.50**      ▼ **\$654.50**

<b>WG</b>	<b>NM</b>	<b>WM</b>
White Gloss Blanc lustré	Black Matt Noir mat	White Matt Blanc mat

#### Features Caractéristiques

- Italian porcelain
- Drain not included
- With overflow
- 16.5 lbs / 7.5 kg

- Porcelaine italienne
- Drain non inclus
- Avec trop-plein
- 16.5 lbs / 7.5 kg

#### Technical Specifications\*\* Spécifications techniques\*\*

**18<sup>7</sup>/<sub>8</sub>" x 14<sup>9</sup>/<sub>16</sub>" x 5<sup>7</sup>/<sub>16</sub>"**  
**480 x 370 x 138 mm**

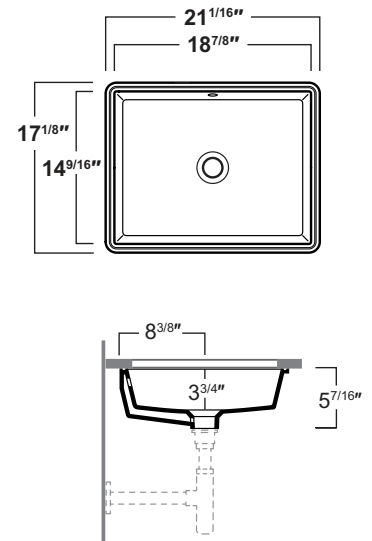

**Special Order – 90 days**  
Commande spéciale – 90 jours **\$654.50**

<b>NE</b>	<b>AN</b>	
Black Gloss Noir lustré	Anthracite Anthracite	
<b>PE</b>	<b>NA</b>	<b>PR</b>
Lavender Blue Bleu lavande	Navy Marine	Plum Prune

\*\*The manufacturer accepts 1/4" (5 mm) variance  
\*\*Le fabricant accepte une tolérance de 1/4" (5mm)

# WASH BASINS – Vanity top LAVABOS – Dessus de vanité



Pending  
En instance

## Wave #WA 80 WG

Stock  
En inventaire

**\$1094.50**

WG

White Gloss  
Blanc lustré

### Features Caractéristiques

- Italian porcelain
- Single faucet hole
- Vanity top (under counter basin)
- Drain not included
- No overflow
- 39.7 lbs / 18 kg

- Porcelaine italienne
- Monotrou
- Dessus de vanité (lavabo sous comptoir)
- Drain non inclus
- Sans trop-plein
- 39.7 lbs / 18 kg

### Technical Specifications\*\* Spécifications techniques\*\*

**31<sup>1</sup>/<sub>2</sub>" x 20<sup>1</sup>/<sub>16</sub>" x 5<sup>1</sup>/<sub>16</sub>"**  
**800 x 510 x 145 mm**

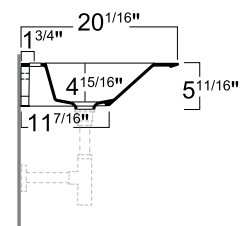
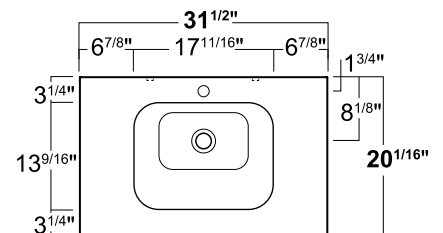

\*\*The manufacturer accepts 1/4" (5 mm) variance  
\*\*Le fabricant accepte une tolérance de 1/4" (5mm)

# WASH BASINS – Vanity top LAVABOS – Dessus de vanité



Pending  
En instance

## Wave #WA 100 WG

Stock  
En inventaire

\$1204.<sup>50</sup>

WG

White Gloss  
Blanc lustré

### Features Caractéristiques

- Italian porcelain
- Single faucet hole
- Vanity top (under counter basin)
- Drain not included
- No overflow
- 48.5 lbs / 22 kg

- Porcelaine italienne
- Monotrou
- Dessus de vanité (lavabo sous comptoir)
- Drain non inclus
- Sans trop-plein
- 48.5 lbs / 22 kg

### Technical Specifications\*\* Spécifications techniques\*\*

39<sup>3</sup>/<sub>8</sub>" x 20<sup>1</sup>/<sub>16</sub>" x 5<sup>1</sup>/<sub>16</sub>"  
1000 x 510 x 145 mm

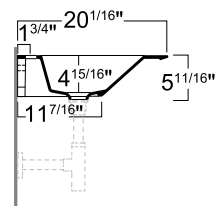
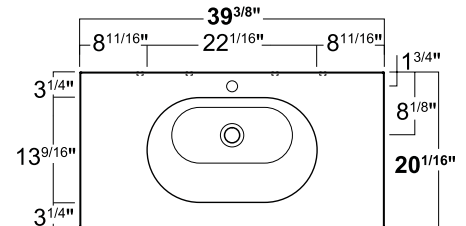

\*\*The manufacturer accepts 1/4" (5 mm) variance  
\*\*Le fabricant accepte une tolérance de 1/4" (5mm)

# WASH BASINS – Vanity top LAVABOS – Dessus de vanité



Pending  
En instance

## Wave #WA 120D WG

Stock  
En inventaire

**\$1534.<sup>50</sup>**

**WG**

White Gloss  
Blanc lustré

### Features Caractéristiques

- Italian porcelain
- Single faucet hole x2
- Vanity top (under counter basin)
- Drain not included
- No overflow
- 58.5 lbs / 26.5 kg

- Porcelaine italienne
- Monotrou x2
- Dessus de vanité (lavabo sous comptoir)
- Drain non inclus
- Sans trop-plein
- 58.5 lbs / 26.5 kg

### Technical Specifications\*\* Spécifications techniques\*\*

**47<sup>1</sup>/<sub>4</sub>" x 20<sup>1</sup>/<sub>16</sub>" x 5<sup>11</sup>/<sub>16</sub>"**  
**1200 x 510 x 145 mm**

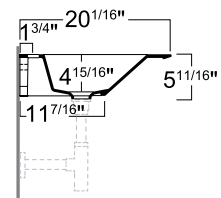
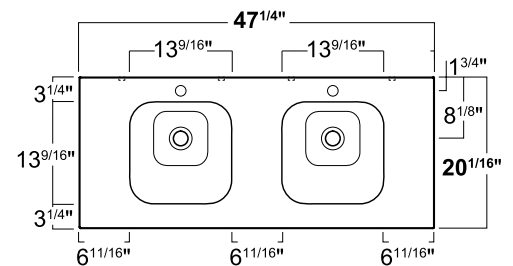

\*\*The manufacturer accepts 1/4" (5 mm) variance  
\*\*Le fabricant accepte une tolérance de 1/4" (5mm)





# Wash basins Lavabos

## Drop-in Encastrés



**Baden Baden**

p.74

**Arcadia**

p.75



► Arcadia #AR835WG White gloss/Blanc lustré p.76



► **Baden Baden** #BB11WG White gloss / Blanc lustré p.74

# WASH BASINS – Drop-in LAVABOS – Encastré



Pending  
En instance

## Baden Baden #BB 11 \_ \_ \*

Stock  
En inventaire

**\$874.50**

**WG**

White Gloss  
Blanc lustré

Special Order – 90 days

Commande spéciale – 90 jours **\$1314.50**

**WM**

White Matt  
Blanc mat

**NM**

Black Matt  
Noir mat

**NE**

Black Gloss  
Noir lustré

**AN**

Anthracite  
Anthracite

### Features Caractéristiques

- Italian porcelain
- Drain not included
- No overflow
- 28.5 lbs / 13 kg

- Porcelaine italienne
- Drain non inclus
- Sans trop-plein
- 28.5 lbs / 13 kg

### Technical Specifications\*\* Spécifications techniques\*\*

**23<sup>5</sup>/<sub>8</sub>" x 14<sup>15</sup>/<sub>16</sub>" x 5<sup>1</sup>/<sub>2</sub>"**  
**600 x 380 x 140 mm**

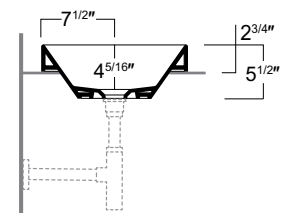
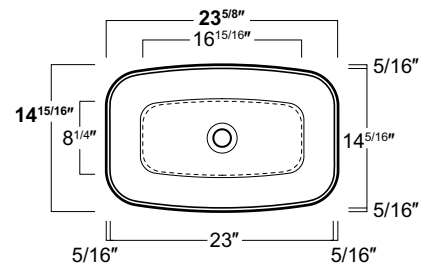

\* 2-letter color code MUST be specified at the end of basin code ( \_ \_ )  
\* Le code couleur de 2 lettres DOIT être ajouté à la fin du code du lavabo ( \_ \_ )

\*\*The manufacturer accepts 1/4" (5 mm) variance  
\*\*Le fabricant accepte une tolérance de 1/4" (5mm)

# WASH BASINS – Drop-in LAVABOS – Encastré



Pending  
En instance

## Arcadia #AR 859 WG

Stock  
En inventaire

\$764.<sup>50</sup>

WG

White Gloss  
Blanc lustré

### Features Caractéristiques

- Italian porcelain
- Single faucet hole/Pre-punched 8" c.c.
- Drain not included
- With overflow
- 24.25 lbs / 11 kg

- Porcelaine italienne
- Monotrou / Pré-percé 8" c.c.
- Drain non inclus
- Avec trop-plein
- 24.25 lbs / 11 kg

### Technical Specifications\*\* Spécifications techniques\*\*

24" x 19<sup>7/8</sup>" x 7<sup>7/8</sup>"  
610 x 505 x 200 mm

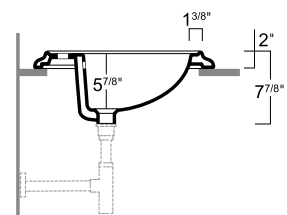
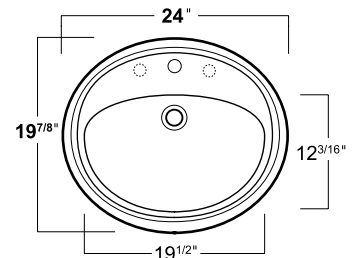

\*\*The manufacturer accepts 1/4" (5 mm) variance  
\*\*Le fabricant accepte une tolérance de 1/4" (5mm)

# WASH BASINS – Drop-in LAVABOS – Encastré



Pending  
En instance

## Arcadia #AR 835 WG

Stock  
En inventaire

**\$764.50**

WG

White Gloss  
Blanc lustré

### Features Caractéristiques

- Italian porcelain
- Single faucet hole/Pre-punched 8" c.c.
- Drain not included
- With overflow
- 33 lbs / 15 kg

- Porcelaine italienne
- Monotrou / Pré-percé 8" c.c.
- Drain non inclus
- Avec trop-plein
- 33 lbs / 15 kg

### Technical Specifications\*\* Spécifications techniques\*\*

**26<sup>3</sup>/<sub>8</sub>" x 12<sup>5</sup>/<sub>16</sub>" x 7<sup>7</sup>/<sub>8</sub>"**  
**670 x 490 x 200 mm**

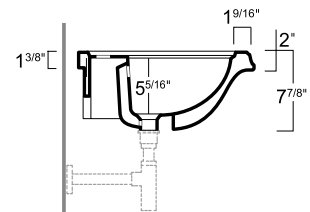
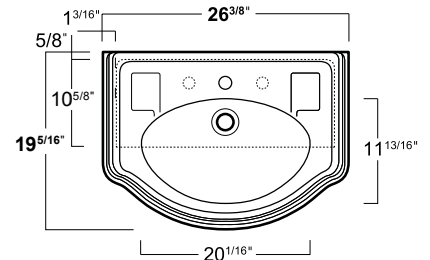

\*\*The manufacturer accepts 1/4" (5 mm) variance  
\*\*Le fabricant accepte une tolérance de 1/4" (5mm)

# Wash basins Lavabos

## Wall hung Suspendus



**Baden Baden**

p.80

**Flow**

p.82



► **Flow #FL21WG** White gloss / Blanc lustré p.82





► **Baden Baden** #BB13WM / #DE15WM White matt/Blanc mat p.80-81



► **Baden Baden** #BB13NM / #DE15NM Black matt/Noir mat p.80-81

# WASH BASINS – Wall hung LAVABOS – Suspendus



## Baden Baden #BB 13 \_\_ \*

Stock  
En inventaire

**\$1754.50**

**WG**

White Gloss  
Blanc lustré

Special Order – 90 days

Commande spéciale – 90 jours **\$2524.50**

**WM**

White Matt  
Blanc mat

**NM**

Black Matt  
Noir mat

**NE**

Black Gloss  
Noir lustré

**AN**

Anthracite  
Anthracite

### Features Caractéristiques

- Italian porcelain
- Single faucet hole
- With overflow
- Mounting kit F87 included
- 48.5 lbs / 22 kg

- Porcelaine italienne
- Monotrou
- Avec trop-plein
- Kit de fixation F87 inclus
- 48.5 lbs / 22 kg

### Technical Specifications\*\* Spécifications techniques\*\*

**15<sup>3</sup>/<sub>4</sub>" x 17<sup>3</sup>/<sub>4</sub>" x 21<sup>5</sup>/<sub>8</sub>"**  
**400 x 450 x 550 mm**

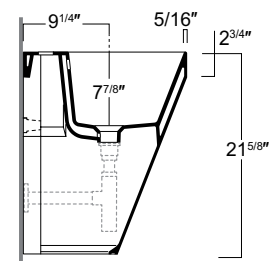
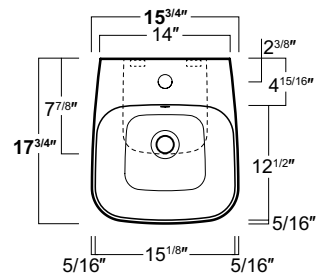

\*\*The manufacturer accepts 1/4" (5 mm) variance  
\*\*Le fabricant accepte une tolérance de 1/4" (5mm)

\* 2-letter color code MUST be specified at the end of basin code ( \_\_ )  
\* Le code couleur de 2 lettres DOIT être ajouté à la fin du code du lavabo ( \_\_ )

# ACCESSORIES ACCESSOIRES



#DE 15



#DE 16

Baden Baden #DE 15 \_\_ \*

Baden Baden #DE 16 \_\_ \*

### Stock

En inventaire

#DE 15 \$324.50

#DE 16 \$434.50

WG

White Gloss  
Blanc lustré

### Special Order - 90 days

Commande spéciale - 90 jours

#DE 15 \$495.00

#DE 16 \$654.50

WM

White Matt  
Blanc mat

NM

Black Matt  
Noir mat

NE

Black Gloss  
Noir lustré

AN

Anthracite  
Anthracite

### Features

Caractéristiques

- Italian porcelain
- Wall hung shelf
- Mounting kit included
- #DE15: 6.6 lbs / 3 kg
- #DE16: 11 lbs / 5 kg

- Porcelaine italienne
- Étagère murale
- Kit de fixation inclus
- #DE15: 6.6 lbs / 3 kg
- #DE16: 11 lbs / 5 kg

### Technical Specifications\*\*

Spécifications techniques\*\*

#### #DE 15

15<sup>3/4</sup>" x 10<sup>5/8</sup>" x 3<sup>1/8</sup>"  
400 x 270 x 80 mm

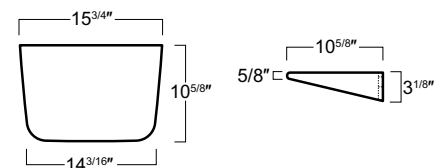

#### #DE 16

23<sup>5/8</sup>" x 5<sup>1/2</sup>" x 2<sup>3/8</sup>"  
600 x 140 x 60 mm

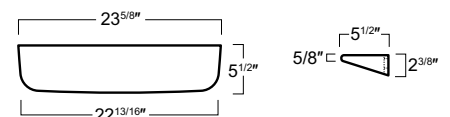

\* 2-letter color code MUST be specified at the end of accessories code ( \_\_ )  
\* Le code couleur de 2 lettres DOIT être ajouté à la fin du code de l'accessoire ( \_\_ )

\*\*The manufacturer accepts 1/4" (5 mm) variance  
\*\*Le fabricant accepte une tolérance de 1/4" (5mm)

# WASH BASINS – Wall hung LAVABOS – Suspendus



## Flow #FL 21 WG

Stock  
En inventaire

**\$874.50**

WG

White Gloss  
Blanc lustré

### Features Caractéristiques

- Italian porcelain
- Right-sided shelf
- Pre-punched for single faucet hole
- No overflow
- Mounting kit not included
- 28.5 lbs / 13 kg

- Porcelaine italienne
- Tablette sur la droite
- Pré-percé pour robinet monotrou
- Sans trop-plein
- Kit de fixation non inclus
- 28.5 lbs / 13 kg

### Technical Specifications\*\* Spécifications techniques\*\*

**19<sup>11</sup>/<sub>16</sub>" x 22<sup>3</sup>/<sub>4</sub>" x 4<sup>3</sup>/<sub>8</sub>"**  
**500 x 575 x 110 mm**

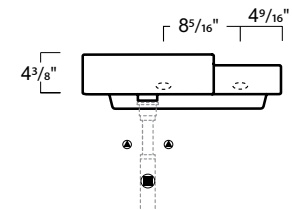
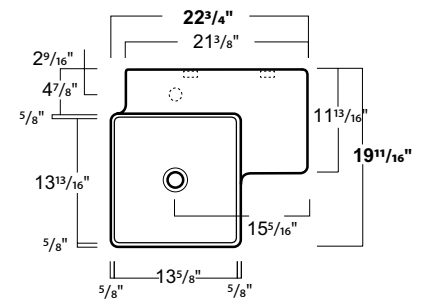

\*\*The manufacturer accepts 1/4" (5 mm) variance  
\*\*Le fabricant accepte une tolérance de 1/4" (5mm)

# WASH BASINS – Wall hung

## LAVABOS – Suspendus



### Flow #FL 24 WG

Stock  
En inventaire

**\$874.50**

WG

White Gloss  
Blanc lustré

#### Features Caractéristiques

- Italian porcelain
- Pre-punched for single faucet hole
- No overflow
- Mounting kit not included
- 26.5 lbs / 12 kg

- Porcelaine italienne
- Pré-percé pour robinet monotrou
- Sans trop-plein
- Kit de fixation non inclus
- 26.5 lbs / 12 kg

#### Technical Specifications\*\* Spécifications techniques\*\*

**19<sup>1</sup>/<sub>2</sub>" x 19<sup>1</sup>/<sub>2</sub>" x 4<sup>3</sup>/<sub>8</sub>"**  
**495 x 495 x 110 mm**

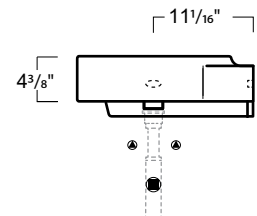
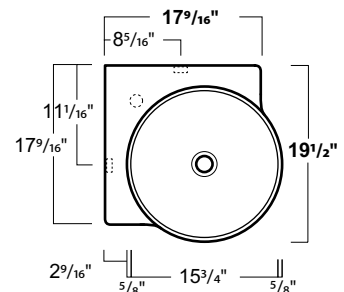

\*\*The manufacturer accepts 1/4" (5 mm) variance  
\*\*Le fabricant accepte une tolérance de 1/4" (5mm)



## Consoles

Wall hung & floormount  
Suspendues et au sol



**Agile**

p.87

**Arcadia**

p.90



► Arcadia #AR864CG1WG White gloss/Blanc lustré p.90



# CONSOLES

## Wall hung – Suspendues

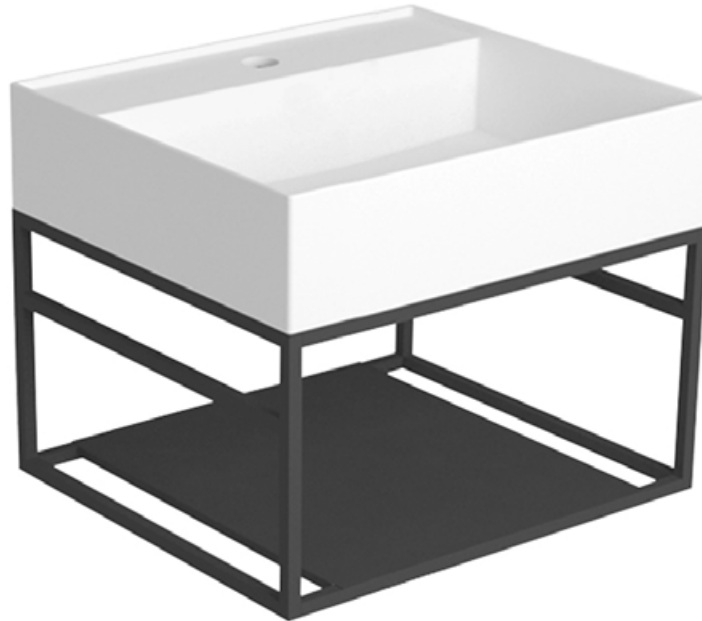

Agile #AG 51CC \_ \_ \* Black Matt frame only  
Structure uniquement noir mat

Stock  
En inventaire

\$2194.50



White Gloss  
Blanc lustré

### Features Caractéristiques

- Italian porcelain
- Single faucet hole
- Drain not included
- No overflow
- Mounting kit F89 included
- Stainless steel structure
- Black matt structure (powder coated)
- 44 lbs / 20 kg

- Porcelaine italienne
- Monotrou
- Drain non inclus
- Sans trop-plein
- Kit de fixation F89 inclus
- Structure en acier inoxydable
- Structure au fini noir mat (revêtement de peinture en poudre)
- 44 lbs / 20 kg

### Technical Specifications\*\* Spécifications techniques\*\*

20<sup>1/16</sup>" x 18<sup>1/8</sup>" x 16<sup>1/8</sup>"  
510 x 460 x 410 mm

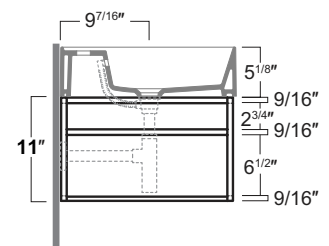
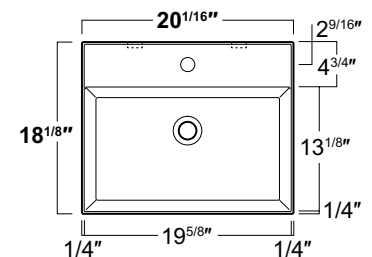

Special Order – 90 days

Commande spéciale – 90 jours

\$2524.50



White Matt  
Blanc mat



Black Matt  
Noir mat



Black Gloss  
Noir lustré



Anthracite  
Anthracite



Lavender Blue  
Bleu lavande



Navy Marine



Plum Prune

\* 2-letter color code MUST be specified at the end of console code ( \_ \_ )  
\* Le code couleur de 2 lettres DOIT être ajouté à la fin du code de la console ( \_ \_ )

\*\*The manufacturer accepts 1/4" (5 mm) variance  
\*\*Le fabricant accepte une tolérance de 1/4" (5mm)

# CONSOLES

Wall hung – Suspendues

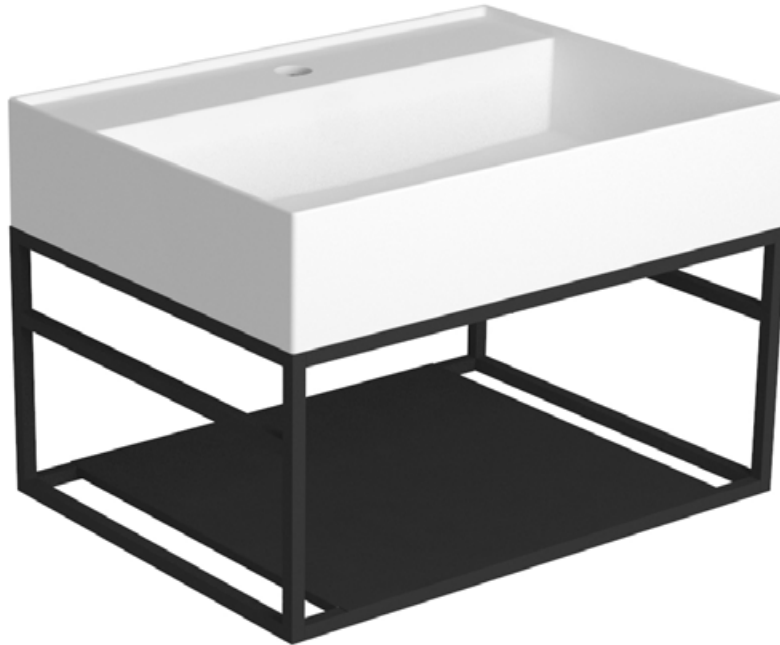

Pending  
En instance

Agile **#AG 61CC** \_ \_ \* Black Matt frame only  
Structure uniquement noir mat

Stock  
En inventaire

**\$2524.50**



White Gloss  
Blanc lustré

Features  
Caractéristiques

- Italian porcelain
- Single faucet hole
- Drain not included
- No overflow
- Mounting kit F89 included
- Stainless steel structure
- Black matt structure (powder coated)
- 52.9 lbs / 24 kg

Technical Specifications\*\*  
Spécifications techniques\*\*

**24" x 18<sup>1</sup>/<sub>8</sub>" x 16<sup>1</sup>/<sub>8</sub>"**  
**610 x 460 x 410 mm**

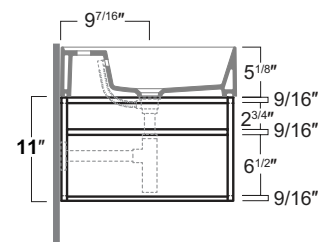
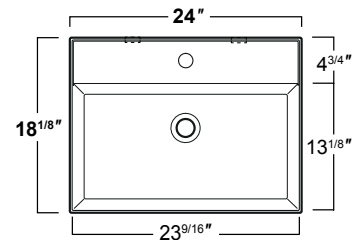

Special Order – 90 days

Commande spéciale – 90 jours **\$2964.50**



White Matt  
Blanc mat



Black Matt  
Noir mat



Black Gloss  
Noir lustré



Anthracite  
Anthracite

- Porcelaine italienne
- Monotrou
- Drain non inclus
- Sans trop-plein
- Kit de fixation F89 inclus
- Structure en acier inoxydable
- Structure au fini noir mat (revêtement de peinture en poudre)
- 52.9 lbs / 24 kg



Lavender Blue  
Bleu lavande



Navy  
Marine



Plum  
Prune

\* 2-letter color code MUST be specified at the end of console code ( \_ \_ )

\* Le code couleur de 2 lettres DOIT être ajouté à la fin du code de la console ( \_ \_ )

\*\*The manufacturer accepts 1/4" (5 mm) variance

\*\*Le fabricant accepte une tolérance de 1/4" (5mm)

# CONSOLES

## Wall hung – Suspendues



Pending  
En instance

Agile **#AG 91CC** \_ \_ \* Black Matt frame only  
Structure uniquement noir mat

Stock  
En inventaire

**\$2964.50**



White Gloss  
Blanc lustré

### Features Caractéristiques

- Italian porcelain
- Single faucet hole
- Drain not included
- No overflow
- Mounting kit F89 included
- Stainless steel structure
- Black matt structure (powder coated)
- 76 lbs / 34.5 kg

### Technical Specifications\*\* Spécifications techniques\*\*

**35<sup>13/16</sup>" x 18<sup>1/8</sup>" x 16<sup>1/8</sup>"**  
**910 x 460 x 410 mm**

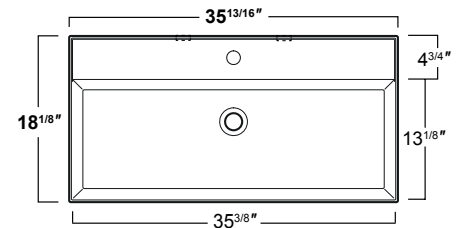

Special Order – 90 days

Commande spéciale – 90 jours **\$3404.50**



White Matt  
Blanc mat



Black Matt  
Noir mat



Black Gloss  
Noir lustré



Anthracite  
Anthracite

- Porcelaine italienne
- Monotrou
- Drain non inclus
- Sans trop-plein
- Kit de fixation F89 inclus
- Structure en acier inoxydable
- Structure au fini noir mat (revêtement de peinture en poudre)
- 76 lbs / 34.5 kg



Lavender Blue  
Bleu lavande



Navy Marine



Plum Prune

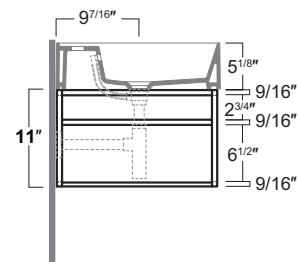

\* 2-letter color code MUST be specified at the end of console code ( \_ \_ )  
\* Le code couleur de 2 lettres DOIT être ajouté à la fin du code de la console ( \_ \_ )

\*\*The manufacturer accepts 1/4" (5 mm) variance  
\*\*Le fabricant accepte une tolérance de 1/4" (5mm)

# CONSOLES

Floormount – Au sol



## Arcadia #AR 864CG1 WG

Stock  
En inventaire

**\$4834.<sup>50</sup>**

WG

White Gloss  
Blanc lustré

### Features Caractéristiques

- Italian porcelain
- Wash basin including stand in chrome finish
- Single faucet hole/Pre-punched 8" c.c.
- Drain not included
- With overflow
- Mounting kit F89 included
- 73.6 lbs / 33.4 kg

- Porcelaine italienne
- Lavabo incluant structure en fini chrome
- Monotrou / Pré-percé 8" c.c.
- Drain non inclus
- Avec trop-plein
- Kit de fixation F89 inclus
- 73.6 lbs / 33.4 kg

### Technical Specifications\*\* Spécifications techniques\*\*

**35<sup>7</sup>/<sub>16</sub>" x 22<sup>1</sup>/<sub>16</sub>" x 37<sup>3</sup>/<sub>8</sub>"**  
**900 x 560 x 950 mm**

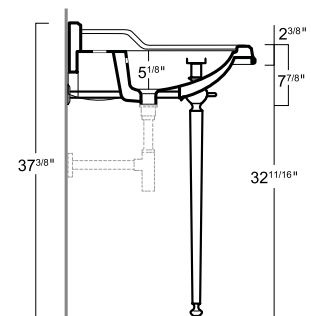
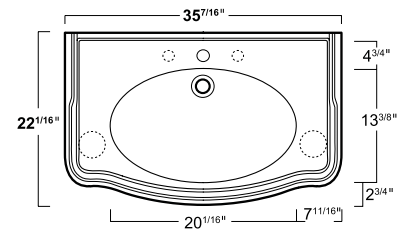

\*\*The manufacturer accepts 1/4" (5 mm) variance  
\*\*Le fabricant accepte une tolérance de 1/4" (5mm)

### Spare parts Pièces de rechange



**Wash basin**  
Lavabo  
▶ Stock  
En inventaire

**AR 864WG**  
**\$1864.<sup>50</sup>**



**Console stand**  
Structure console  
▶ Stock  
En inventaire

**ARCG1**  
**\$2937**



**Mounting kit**  
Kit de fixation  
▶ Stock  
En inventaire

**F89**  
**\$33**

# CONSOLES

Floormount – Au sol



## Arcadia #AR 8642GB WG

Stock  
En inventaire

**\$2997.50**

WG

White Gloss  
Blanc lustré

### Features Caractéristiques

- Italian porcelain
- Wash basin including set of legs
- Single faucet hole/Pre-punched 8" c.c.
- Drain not included
- With overflow
- Mounting kit F89 included
- 79.4 lbs / 36 kg

### Technical Specifications\*\* Spécifications techniques\*\*

**35<sup>7</sup>/<sub>16</sub>" x 22<sup>1</sup>/<sub>16</sub>" x 36<sup>5</sup>/<sub>8</sub>"**  
**900 x 560 x 930 mm**

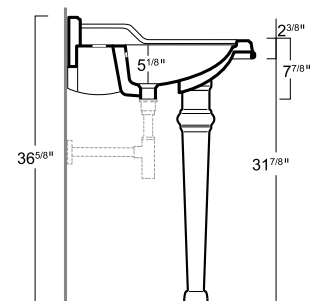
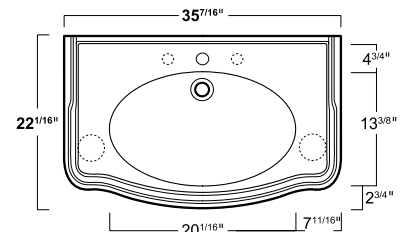

- Porcelaine italienne
- Lavabo incluant une paire de pieds
- Monotrou / Pré-percé 8" c.c.
- Drain non inclus
- Avec trop-plein
- Kit de fixation F89 inclus
- 79.4 lbs / 36 kg

\*\*The manufacturer accepts 1/4" (5 mm) variance  
\*\*Le fabricant accepte une tolérance de 1/4" (5mm)

### Spare parts Pièces de rechange



**Wash basin**  
Lavabo

**AR 864WG**

▶ Stock  
En inventaire

**\$1864.50**



**Ceramic leg**  
Pied en céramique

**GB001WG**

▶ Stock  
En inventaire

**\$550**



**Mounting kit**  
Kit de fixation

**F89**

▶ Stock  
En inventaire

**\$33**

# CONSOLES

Floormount – Au sol



## Arcadia #AR 874CG2 WG

Stock  
En inventaire

**\$5258**

WG

White Gloss  
Blanc lustré

### Features Caractéristiques

- Italian porcelain
- Wash basin including stand in chrome finish
- Single faucet hole/Pre-punched 8" c.c.
- Drain not included
- With overflow
- Mounting kit F89 included
- 84.85 lbs / 38.5 kg

- Porcelaine italienne
- Lavabo incluant structure en fini chrome
- Monotrou / Pré-percé 8" c.c.
- Drain non inclus
- Avec trop-plein
- Kit de fixation F89 inclus
- 84.85 lbs / 38.5 kg

### Technical Specifications\*\* Spécifications techniques\*\*

**41<sup>5/16</sup>" x 22<sup>1/16</sup>" x 37<sup>3/8</sup>"**  
**1050 x 560 x 950 mm**

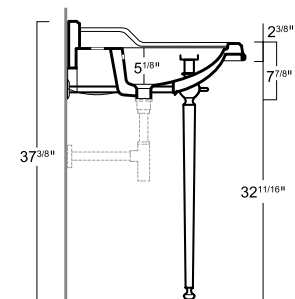
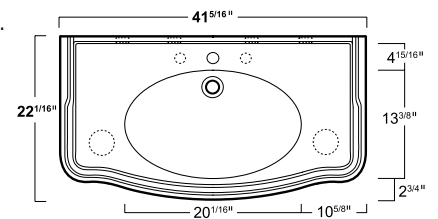

\*\*The manufacturer accepts 1/4" (5 mm) variance  
\*\*Le fabricant accepte une tolérance de 1/4" (5mm)

### Spare parts Pièces de rechange



Wash basin  
Lavabo

▶ Stock  
En inventaire

**AR 874WG**

**\$2161<sup>-50</sup>**



Console stand  
Structure console

▶ Stock  
En inventaire

**ARCG2**

**\$3063<sup>-50</sup>**



Mounting kit  
Kit de fixation

▶ Stock  
En inventaire

**F89**

**\$33**

# CONSOLES

Floormount – Au sol



## Arcadia #AR 8742GB WG

Stock  
En inventaire

**\$3294.<sup>50</sup>**

WG

White Gloss  
Blanc lustré

### Features Caractéristiques

- Italian porcelain
- Wash basin including set of legs
- Single faucet hole/Pre-punched 8" c.c.
- Drain not included
- With overflow
- Mounting kit F89 included
- 90.4 lbs / 41 kg

### Technical Specifications\*\* Spécifications techniques\*\*

**41<sup>5</sup>/<sub>16</sub>" x 22<sup>1</sup>/<sub>16</sub>" x 36<sup>5</sup>/<sub>8</sub>"**  
**1050 x 560 x 930 mm**

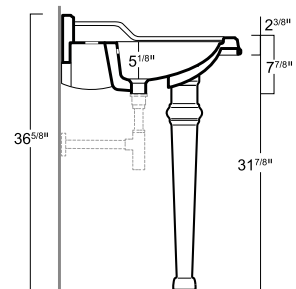
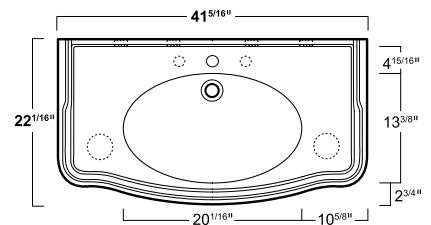

- Porcelaine italienne
- Lavabo incluant une paire de pieds
- Monotrou / Pré-percé 8" c.c.
- Drain non inclus
- Avec trop-plein
- Kit de fixation F89 inclus
- 90.4 lbs / 41 kg

\*\*The manufacturer accepts 1/4" (5 mm) variance  
\*\*Le fabricant accepte une tolérance de 1/4" (5mm)

### Spare parts Pièces de rechange



**Wash basin**  
Lavabo

**AR 874WG**

▶ Stock  
En inventaire

**\$2161.<sup>50</sup>**



**Ceramic leg**  
Pied en céramique

**GB001WG**

▶ Stock  
En inventaire

**\$550**



**Mounting kit**  
Kit de fixation

**F89**

▶ Stock  
En inventaire

**\$33**



► Sharp #FM02GW Grey Ashwood & White Matt / Frêne gris et blanc mat p.97



# Structures & Countertops

## Structures et comptoirs

Wall hung & floormount  
Suspendus et au sol



**Sharp**  
p.96

**Vignoni**  
p.98

# STRUCTURES

Floormount – Au sol



Sharp #FM 01 \_ \_

\* Black Matt frame only  
Structure uniquement noir mat

Stock  
En inventaire

\$3734.50



Dark Oak  
Chêne foncé



Grey Ashwood & White Matt  
Frêne gris et blanc mat

Features  
Caractéristiques

- High quality textured laminate
- Open cabinet always on right side
- Push to open drawer
- Adjustable feet
- Must be secured to wall
- 121 lbs / 55 kg

- Stratifié texturé de haute qualité
- Rangement ouvert toujours sur la droite
- Tiroir « pousser pour ouvrir »
- Pieds réglables
- Doit être fixé au mur
- 121 lbs / 55 kg

Technical Specifications\*\*  
Spécifications techniques\*\*

41<sup>3</sup>/<sub>8</sub>" x 22<sup>7</sup>/<sub>16</sub>" x 31<sup>1</sup>/<sub>8</sub>"  
1050 x 570 x 790 mm

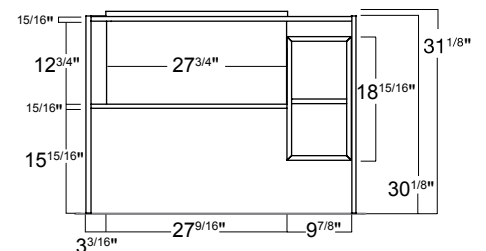
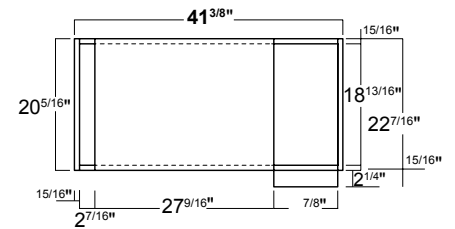

# STRUCTURES

Floormount – Au sol



Sharp #FM 02 \_ \_

\* Black Matt frame only  
Structure uniquement noir mat

Stock  
En inventaire

\$5934.<sup>50</sup>



Dark Oak  
Chêne foncé



Grey Ashwood & White Matt  
Frêne gris et blanc mat

## Features Caractéristiques

- High quality textured laminate
- Push to open drawer
- Adjustable feet
- Must be secured to wall
- 172 lbs / 78 kg

- Stratifié texturé de haute qualité
- Tiroir « pousser pour ouvrir »
- Pieds réglables
- Doit être fixé au mur
- 172 lbs / 78 kg

## Technical Specifications\*\* Spécifications techniques\*\*

71<sup>3</sup>/<sub>8</sub>" x 22<sup>7</sup>/<sub>16</sub>" x 31<sup>1</sup>/<sub>8</sub>"  
1810 x 570 x 790 mm

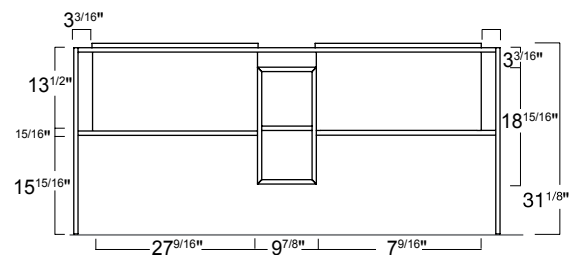
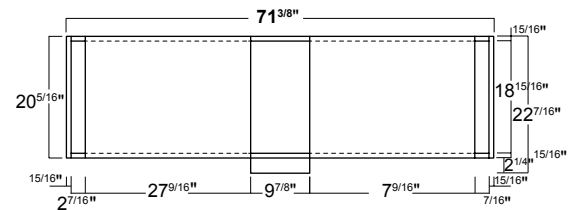

\* 2-letter color code MUST be specified at the end of structure code ( \_ \_ )  
\* Le code couleur de 2 lettres DOIT être ajouté à la fin du code de la structure ( \_ \_ )

\*\*The manufacturer accepts 1/4" (5 mm) variance  
\*\*Le fabricant accepte une tolérance de 1/4" (5mm)

# COUNTERTOPS – Wall hung

# COMPTOIRS – Suspendus



## Vignoni #VIM1LO

**Stock**  
En inventaire

**\$1094.50**



Light Oak  
Chêne clair

### Features Caractéristiques

- Waterproof
- Fixing kit included
- Can be combined with Sharp wash basins (except SH01)
- 27.5 lbs / 12,5 kg

- Imperméable
- Kit de fixation inclus
- Peut être combiné aux lavabos Sharp (à l'exception de SH01)
- 27.5 lbs / 12,5 kg



▶ **Side towel holder available, p.101**  
**Porte-serviettes latéral disponible, p.101**

### Technical Specifications\*\* Spécifications techniques\*\*

**47<sup>1/4</sup>" x 18<sup>3/16</sup>" x 3<sup>15/16</sup>"**  
**1200 x 460 x 100 mm**

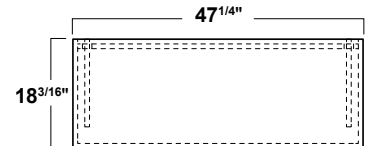

# COUNTERTOPS – Wall hung COMPTOIRS – Suspendus



## Vignoni #VIM2LO

**Stock**  
En inventaire

**\$1204.50**



Light Oak  
Chêne clair

### Features Caractéristiques

- Waterproof
- Fixing kit included
- Can be combined with Sharp wash basins (except SH01)
- 32 lbs / 14,5 kg

- Imperméable
- Kit de fixation inclus
- Peut être combiné aux lavabos Sharp (à l'exception de SH01)
- 32 lbs / 14,5 kg



▶ Side towel holder available, p.101  
Porte-serviettes latéral disponible, p.101

### Technical Specifications\*\* Spécifications techniques\*\*

**55<sup>1</sup>/<sub>8</sub>" x 18<sup>3</sup>/<sub>16</sub>" x 3<sup>15</sup>/<sub>16</sub>"**  
**1400 x 460 x 100 mm**

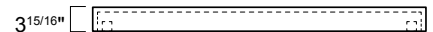
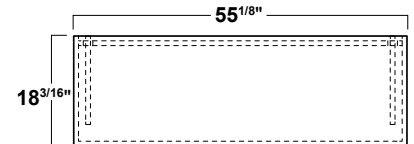

# MODULAR DRAWER – Wall hung

# TIROIR MODULAIRE – Suspendu



## Vignoni #VIM3 \_ \_ \*

**Stock**  
En inventaire

▼ \$1314.50

▼ \$1424.50

**WG**

White Gloss  
Blanc lustré

**AN**

Anthracite  
Anthracite

### Features Caractéristiques

- Push to open drawer
- Fixing kit included
- 46 lbs / 21 kg

- Tiroir « pousser pour ouvrir »
- Kit de fixation inclus
- 46 lbs / 21 kg

### Technical Specifications\*\* Spécifications techniques\*\*

**27<sup>9</sup>/<sub>16</sub>" x 18<sup>3</sup>/<sub>16</sub>" x 10<sup>7</sup>/<sub>16</sub>"**  
**700 x 460 x 260 mm**

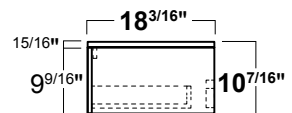
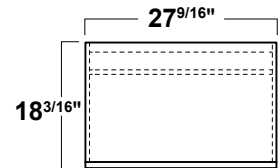

# SIDE TOWEL HOLDER PORTE-SERVIETTES LATÉRAL



## Vignoni #VIP1

Stock  
En inventaire

\$467.50



Chrome

### Features Caractéristiques

- Side towel holder for VIM1 / VIM2
- Chrome plated brass
- 0.7 lbs / 0.3 kg
- Porte-serviettes latéral pour VIM1 / VIM2
- Laiton plaqué chromé
- 0.7 lbs / 0.3 kg

### Technical Specifications\*\* Spécifications techniques\*\*

**18<sup>3/16</sup>" x 3<sup>3/16</sup>" x 5/8"**  
**460 x 75 x 15 mm**

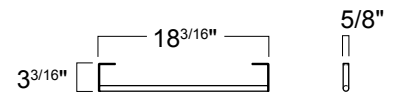





# Mirrors Miroirs



**Sharp**

p.104

**Vignoni**

p.105

# MIRROR MIROIR

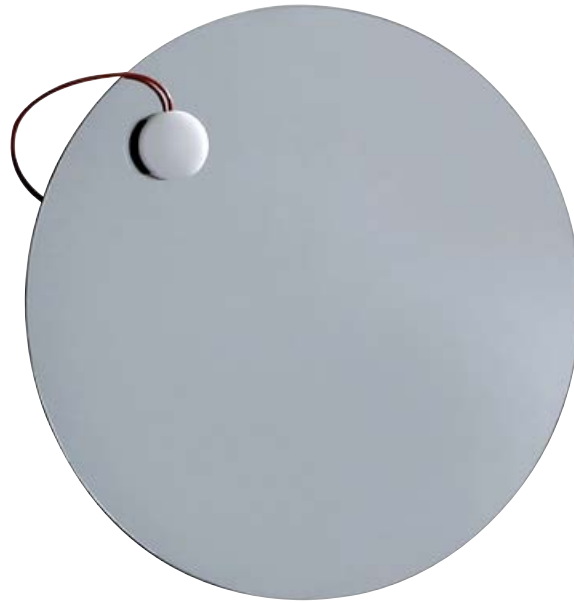

## Sharp #FS4

Stock  
En inventaire

**\$1094.50**

### Features Caractéristiques

- Magnetic lamp included
- 3000K LED light
- Must be hardwired to a wall switch
- Low voltage electrical transformer included
- cUL certified
- 11 lbs / 5 kg

- Lampe magnétique incluse
- Doit être branchée à une prise électrique murale
- Lumière DEL 3000 K
- Transformateur électrique basse tension inclus
- Certifié cUL
- 11 lbs / 5 kg

### Technical Specifications\*\* Spécifications techniques\*\*

**ø 27<sup>3</sup>/<sub>4</sub>"**  
**ø 700 mm**

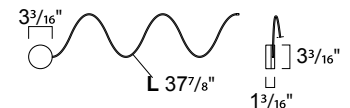
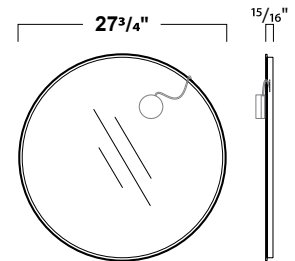

\*\*The manufacturer accepts 1/4" (5 mm) variance  
\*\*Le fabricant accepte une tolérance de 1/4" (5mm)

# MIRROR MIROIR



## Vignoni #VIS1

Stock  
En inventaire

**\$544.50**

### Features Caractéristiques

- Aluminum frame
- 16.5 lbs / 7.5 kg
  
- Structure en aluminium
- 16.5 lbs / 7.5 kg



▶ LED lamp available, p.107  
Lampe DEL disponible, p.107

### Technical Specifications\*\* Spécifications techniques\*\*

**47<sup>1/4</sup>" x 15<sup>3/4</sup>" x 1<sup>1/16</sup>"**  
**1200 x 400 x 25 mm**

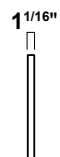
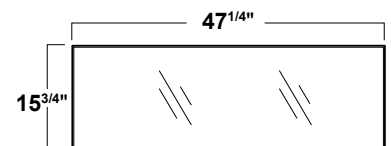

# MIRROR MIROIR



## Vignoni #VIS2

**Stock**  
En inventaire

**\$654.50**

### Features Caractéristiques

- Aluminum frame
- 17.5 lbs / 8 kg
- Structure en aluminium
- 17.5 lbs / 8 kg



▶ **LED lamp available, p.107**  
**Lampe DEL disponible, p.107**

### Technical Specifications\*\* Spécifications techniques\*\*

**55<sup>1</sup>/<sub>8</sub>" x 15<sup>3</sup>/<sub>4</sub>" x 1<sup>1</sup>/<sub>16</sub>"**  
**1400 x 400 x 25 mm**

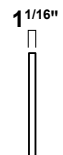
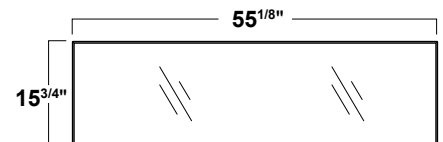

# LAMP LAMPE



## Vignoni #VIL1

**Stock**  
En inventaire

**\$544.50**

### Features Caractéristiques

- Lamp for VIS1 /VIS2 mirrors
- Must be hardwired to a wall switch
- 3000K LED light
- Low voltage electrical transformer included
- cUL certified
- 1 lbs / 0.5 kg

- Lampe pour miroirs VIS1 /VIS2
- Doit être branchée à un interrupteur électrique mural
- Lumière à 3000K
- Transformateur électrique basse tension inclus
- Certifié cUL
- 1 lbs / 0.5 kg

### Technical Specifications\*\* Spécifications techniques\*\*

**21<sup>11/16</sup>" x 2<sup>3/4</sup>" x 1<sup>3/16</sup>"**  
**550 x 70 x 10 mm**

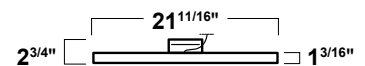

# MAINTENANCE

## ENTRETIEN

For cleaning use only mild cleaners and dry with a soft cloth. Do not use abrasive, corrosive, alcohol, acids or solvents. Do not use abrasive sponges, steel wools, etc. as they damage the product surface. In case of limestone or aggressive water, dry right after use because the deposits could affect the product surface.

Pour le nettoyage, utiliser uniquement des nettoyeurs doux et sécher avec un chiffon doux. Ne pas utiliser de produits abrasifs, corrosifs ou contenant des alcools, des acides ou des solvants. Éviter l'utilisation d'éponges abrasives, laine d'acier, etc. qui endommagent irrémédiablement les surfaces des produits, affectant ainsi la finition brillante ou satinée. En présence de calcaire ou d'eau dure, sécher après utilisation car les dépôts pourraient affecter la surface du produit.



# WARRANTY

# GARANTIE

This document explains the warranty for products purchased from SIMAS, according to the conditions described below:

1. The WARRANTY allows SIMAS, to either repair or replace the product in accordance with what is deemed the best solution for the defective product. This warranty applies to product sold by an authorized retailer within the territory of the United States of America and Canada. Sales made outside the United States of America and Canada are not included within the scope of this warranty unless expressly agreed by SIMAS.
2. This warranty does not cover labor and shipping charges, or damages whatever incurred in the sole or in part from installation, removal, re-installation, repair or replacement of any SIMAS product or part, as well as any incidental or consequential damages, expenses, losses, direct or indirect, arising from any cause whatsoever.
3. The duration of the warranty is 2 years from the invoice or receipt date of the purchase or, if applicable, the delivery note if its date was after of the aforementioned documents. If the product was a display or demonstration model for the retailer, the warranty will only be applicable for one year.
4. SIMAS guarantees its products and components against any manufacturing defect, provided that they have been correctly installed (in compliance with the standard in force and the instructions indicated for their assembly, maintenance and conservation) and that they have been used correctly and as their design intended.
5. Consumable articles (rubber elements, gaskets, etc.) are not covered by this warranty.
6. The following is excluded from this WARRANTY:
  - a. Damage resulting from transport.
  - b. Damage resulting from incorrect installation, handling or repairs performed by staff not authorized by SIMAS, as well as damage due to natural wear, poor treatment, and use and maintenance which is incorrect, unsuitable, abnormal or different from usual and/or to that indicated in the relevant instructions.
  - c. Damage caused by dirt, limescale and other physical, chemical or electrochemical defects.
  - d. Damage, or loss sustained in any natural calamity such as fire, earthquake, flood, thunder, electrical storm, etc.
  - e. Damage which, viewed objectively, cannot be attributed to the manufacturer.
7. This warranty is extended to the first purchaser at retail and is not transferable. The original sales receipt must be available to exercise the warranty.
8. For any questions or warranty service requests, please contact SIMAS' North American distributor, AD WATERS:

## AD WATERS CANADA:

Quebec & Ottawa region: 1 888 ADW-9336 or tech@ad-waters.com  
Western Canada, Ontario & Maritimes: 1 888 ADW-9336 or  
techtoronto@ad-waters.com  
U.S.A.: 1 888 ADW-9336 or techus@ad-waters.com

Ce document détaille les conditions de la garantie offerte par SIMAS sur les produits qu'elle commercialise, conformément aux conditions indiquées ci-après :

1. La GARANTIE permet à SIMAS de réparer ou de remplacer le produit selon la meilleure solution considérée pour le produit défectueux. Cette garantie est appliquée à des produits vendus par un distributeur autorisé sur le territoire des États-Unis d'Amérique et du Canada. Les ventes effectuées hors des États-Unis et du Canada ne sont pas incluses dans la portée de cette garantie sauf accord exprès de SIMAS.
2. Cette garantie ne couvre pas les frais de main d'œuvre et d'envoi, ni les dommages encourus totalement ou partiellement lors de l'installation, du déménagement, de la réinstallation, de la réparation ou du remplacement de tout produit ou de toute pièce de SIMAS, ainsi que les dommages, frais, pertes, directs ou indirects, accidentels ou consécutifs, résultant de toute cause.
3. La durée de la garantie est de 2 ans à partir de la date de facturation ou de la date du reçu de l'achat ou, le cas échéant, de la date de la livraison si celle-ci n'est pas postérieure aux documents mentionnés au préalable. Si le produit est un modèle d'exposition ou de démonstration chez un détaillant, la garantie n'est applicable que pendant un an.
4. SIMAS garantit ses produits et composants contre tout défaut de fabrication à condition qu'ils aient été correctement installés (conformément à la réglementation en vigueur et aux instructions indiquées pour leur montage, entretien et conservation) et qu'ils aient été correctement utilisés tel que leur conception le prévoyait.
5. Les articles consommables (éléments en caoutchouc, joints, etc.) ne sont pas couverts par cette garantie.
6. La GARANTIE présente exclut ce qui suit :
  - a. Dommages résultant du transport.
  - b. Dommages résultant d'une installation incorrecte, d'une manipulation ou de réparations effectuées par un personnel non autorisé par SIMAS; de même que les dommages résultant de l'usure naturelle, du mauvais traitement et de l'utilisation et de l'entretien incorrects, inadéquats, anormaux ou différents de ce qui est habituel et/ou de ceux indiqués sur les instructions correspondantes.
  - c. Dommages causés par de la saleté, du calcaire et d'autres défauts physiques, chimiques ou électrochimiques.
  - d. Dommages ou pertes provoquées par toute catastrophe naturelle comme un feu, un séisme, une inondation, du tonnerre, un orage électrique, etc.
  - e. Dommages qui, objectivement, ne peuvent pas être attribués au fabricant.
7. Cette garantie s'étend au premier acheteur au commerce de vente au détail et il n'est pas transmissible. Le reçu d'achat original doit être disponible afin d'exercer la garantie.
8. Pour toute question ou demande de service de garantie, veuillez prendre contact avec le distributeur nord-américain de SIMAS, AD WATERS :

## AD WATERS CANADA:

Québec et région d'Ottawa: 1 888 ADW-9336 ou tech@ad-waters.com  
Ouest du Canada, Ontario et provinces maritimes: 1 888 ADW-9336 ou  
techtoronto@ad-waters.com  
États-Unis: 1 888 ADW-9336 ou techus@ad-waters.com

# simas

simasusa.com



SIMAS is distributed exclusively in North America by:  
SIMAS est distribué en Amérique du Nord en exclusivité par :

## AD WATERS

ad-waters.com

1 888 ADW-9336

SICAT2022CANUSA

