



fiora

Shower bases, panels & sinks
Bases de douche, panneaux et lavabos

USA - CANADA

*All prices are subject to change, please refer to customer care department to validate all current pricing
*Tous les prix sont sujets à changement, veuillez vous référer au département du service à la clientèle pour valider les prix courants.



Distributed by / Distribué par:

A+ WATERS

Fiora, 30 years of innovation and design

Fiora designs and manufactures complete bathroom solutions that will help you harmonize color and texture in your decor.

Shower bases, wall panels, furniture and sinks, with a unique texture to the touch that can be combined to create your ideal oasis.

Fiora, 30 ans d'innovation et de design

Fiora conçoit et fabrique des solutions complètes pour la salle de bain qui vous permettront d'harmoniser la couleur et la texture de votre décor.

Les bases de douche, les panneaux muraux, les meubles et les lavabos ont une texture unique au toucher et peuvent être combinés pour créer votre oasis idéale.

Silexpol

ADVANCED TECHNOLOGICAL MATERIAL

All Fiora shower bases are made of Silexpol, a high-density material made of an agglomeration of silica, quartz and polymer, enhanced with Nanobath and Metalface technologies.

UN MATÉRIAU TECHNOLOGIQUE D'AVANT-GARDE

Toutes les bases de douche Fiora sont fabriquées en Silexpol, un matériau de haute densité fait d'un assemblage de silice, de quartz et de polymère et intégrant les technologies Nanobath et Metalface.



Comfortable to the touch
Confortable au toucher



Anti-slip Grade 3*
Antidérapant Classe 3*



Customizable
Personnalisable



5-year warranty
Garantie de 5 ans



100% waterproof
100% imperméable



Noise reduction
Réduction du bruit



Easy and fast installation
Installation simple et rapide



Easy repair
Réparation facile

*Grade 3 is the highest anti-slip level in the industry for this type of product.

*Classe 3 est le plus haut niveau d'antidérapant reconnu dans l'industrie pour ce type de produit.



Quality certifications for bases:

Certifications de qualité pour les bases de douche:





Nanobath

BACTERIOSTATICAL AND FUNGISTATICAL TECHNOLOGY.
TECHNOLOGIE BACTÉRIOSTATIQUE ET FONGISTATIQUE.



Prevents the appearance of fungus and bacterial cultures.

Prévient l'apparition de cultures fongiques et bactériennes.



Reduces the appearance of surface stains.

Réduit l'apparition de taches de surface.



The technology lasts forever.

La technologie perdure dans le temps.

Metalface

MATERIAL SURFACE HARDENING TECHNOLOGY.
SYSTÈME DE DURCISSEMENT DE LA SURFACE.



More resistant to impacts.

Plus grande résistance aux chocs.



Easier cleaning.

Entretien plus facile.



More resistant to scratches.

Plus grande résistance aux rayures.



SILEX shower base
European patent
Brevet européen de la
base de douche SILEX



SILEX shower base
National patent
Brevet national de la
base de douche SILEX



Slate

The soft and comfortable slate texture is unique to FIORA's products. Made with a technology that combines aesthetic and ease of maintenance, this solid surface has a natural stone aspect equal to none.

Ardoise

La texture ardoise, douce et confortable, est unique aux produits Fiora. Elle représente très fidèlement l'aspect de la pierre d'ardoise naturelle et est fabriquée avec une technologie permettant aux produits d'allier l'esthétique à l'aisance d'utilisation et d'entretien.

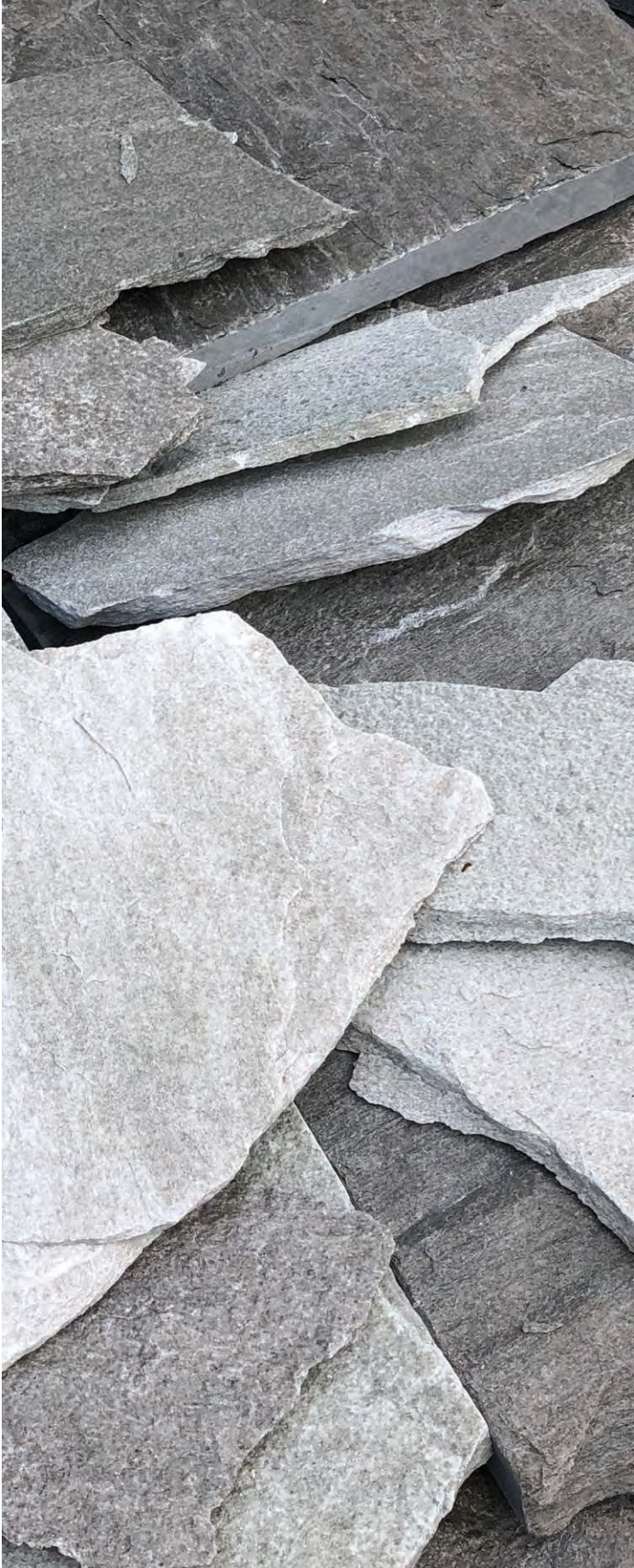

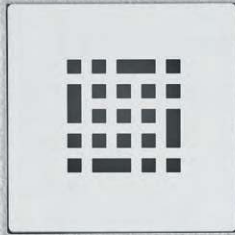

Total White
Blanc pur
0P - STOCK

Cement
Ciment
37T - STOCK

Black
Noir
22T - STOCK

Fiora Colors Couleurs Fiora

Cappuccino
36T - STOCK

Off White
Blanc cassé
0T - ON ORDER
SUR COMMANDE

Silk Grey
Gris soyeux
21M - ON ORDER
SUR COMMANDE

Bone
Ivoire
40T - ON ORDER
SUR COMMANDE

Grey
Gris
31T - ON ORDER
SUR COMMANDE

Production and Testing Production et tests

HI-TECH MANUFACTURING

Fiora develops its products in a fully integrated 200,000 sq ft manufacturing facility, dedicated to development, design, manufacturing, quality control and much more.

PRODUCTION AVEC TECHNOLOGIE DE POINTE

Fiora développe ses produits avec les plus récentes technologies dans une installation de production de 200 000 pi² dédiée au développement, à la conception, à la production, au contrôle de la qualité et plus encore.



Made in Spain
Fabriqué en
Espagne



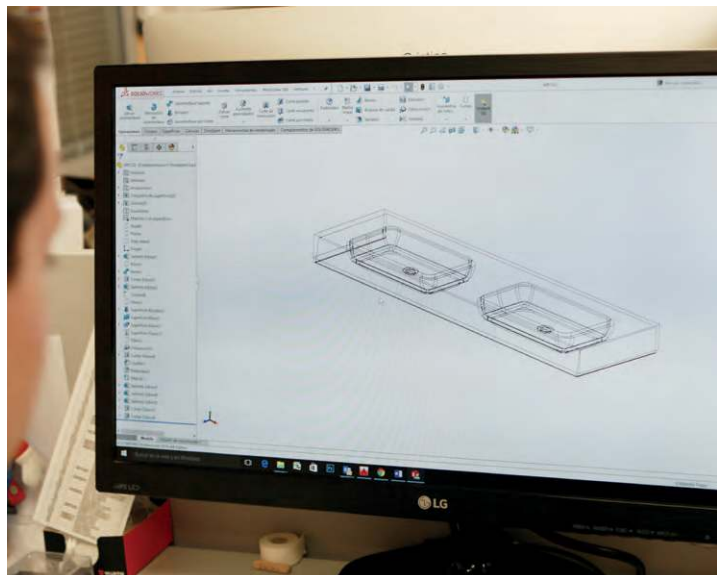

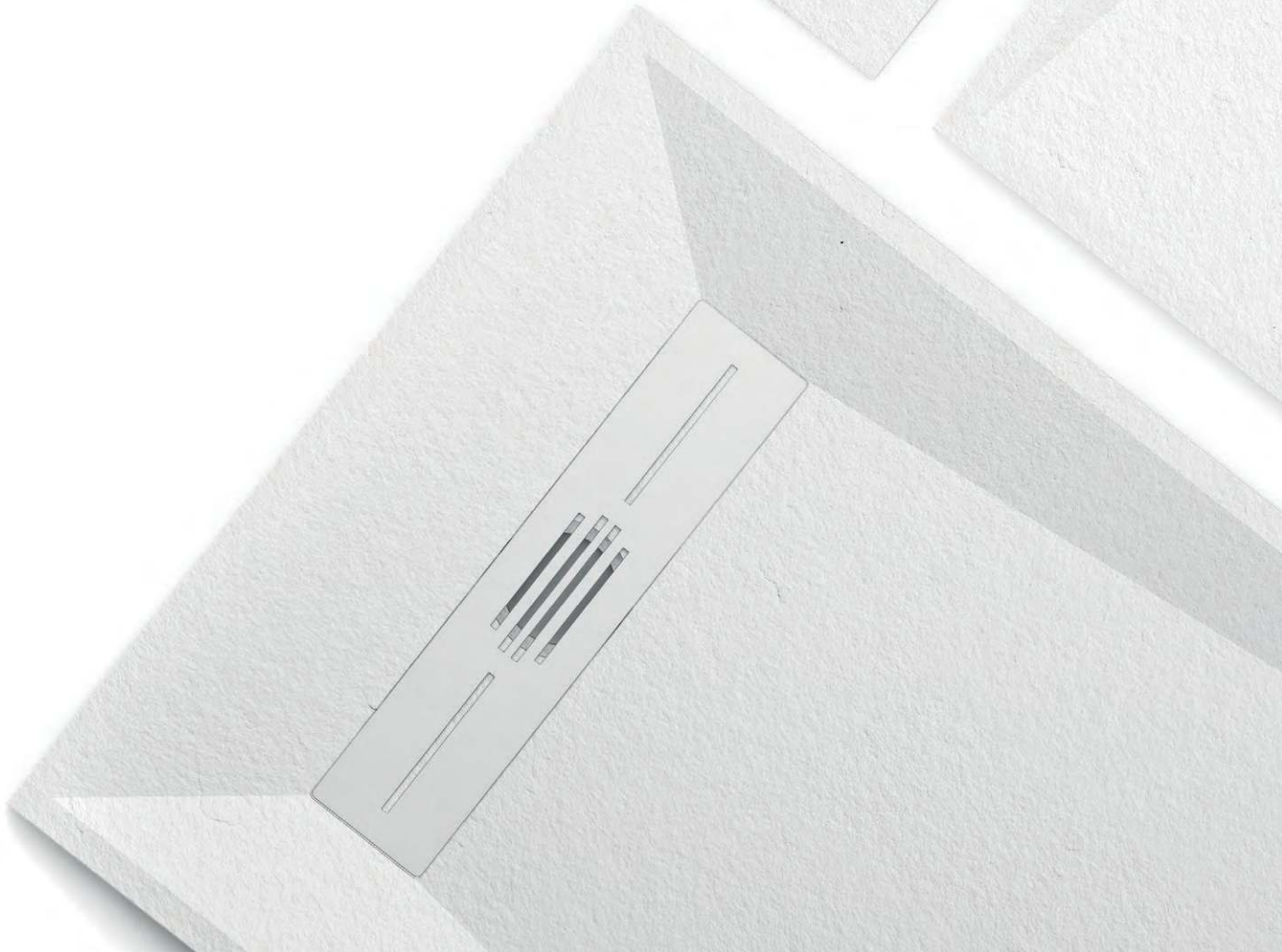
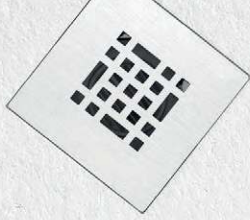



Shower Bases **Bases de douche**

QUADRO - LINEA
COLLECTIONS

Versatile Installation

Installation polyvalente

INSTALLATION OPTIONS
OPTIONS D'INSTALLATION



Flush with floor for ADA application
Encastré pour une application ADA



Above floor
Au-dessus du sol



Fits Your Space S'adapte à votre espace

ADAPTABLE TO NON-STANDARD INSTALLATIONS
S'ADAPTE AUX INSTALLATIONS ATYPIQUES

Adaptable to complex spaces such as corners, columns and inclined walls.
S'adapte aux espaces complexes tels que les coins, les colonnes et les murs inclinés.

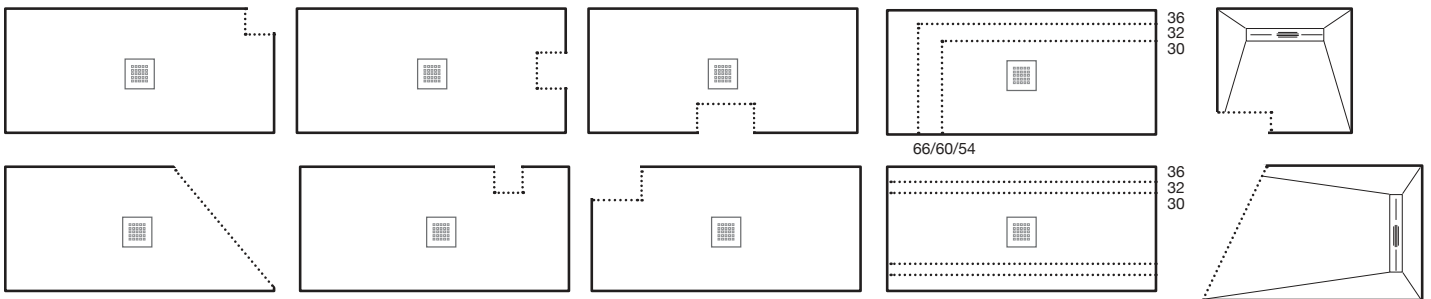

CUT TO SIZE ON JOB SITE
DÉCOUPEZ SUR MESURE AU CHANTIER

Cut with a diamond blade
Coupez avec une lame de diamant

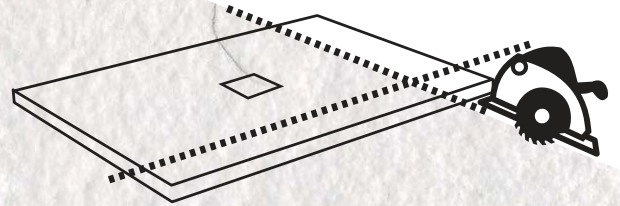



Quadro SSP72420P

72" x 42" / 1829 x 1067 mm
Total White color 0P
Couleur Blanc pur 0P



Quadro

—
SHOWER BASES - BASES DE DOUCHE





^ **Quadro SSP724222T**

72" x 42" / 1829 x 1067 mm
Black color 22T
Couleur Noir 22T

< **Quadro SSP724236T**

72" x 42" / 1829 x 1067 mm
Cappuccino color 36T
Couleur Cappuccino 36T

Quadro

Square centered drain / Drain carré centré

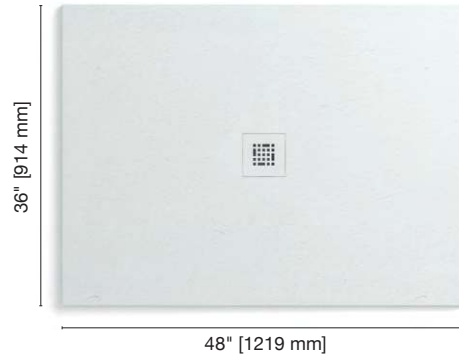
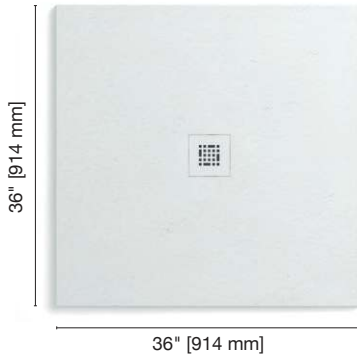

\$1,204.50 stock / en inventaire
\$1,534.50 special order / commande spéciale

Thickness / Épaisseur: 15/16" [24 mm]
 Weight / Poids: 71 lbs / 32 kg

\$1,595 stock / en inventaire
\$1,974.50 special order / commande spéciale

Thickness / Épaisseur: 1" [26 mm]
 Weight / Poids: 104 lbs / 47 kg

Code **Stock**

- SSSP36360P**
Total White / Blanc pur

●
- SSSP363622T**
Black / Noir

●
- SSSP363636T**
Cappuccino

●
- SSSP363637T**
Cement / Ciment

●

Other color options – special order p.27
 Autres options de couleurs – commande spéciale p.27



Code **Stock**

- SSSP48360P**
Total White / Blanc pur

●
- SSSP483622T**
Black / Noir

●
- SSSP483636T**
Cappuccino

●
- SSSP483637T**
Cement / Ciment

●

Other color options – special order p.27
 Autres options de couleurs – commande spéciale p.27



TECHNICAL FEATURES AND PRICE LIST |
 CARACTÉRISTIQUES TECHNIQUES ET LISTE DE PRIX

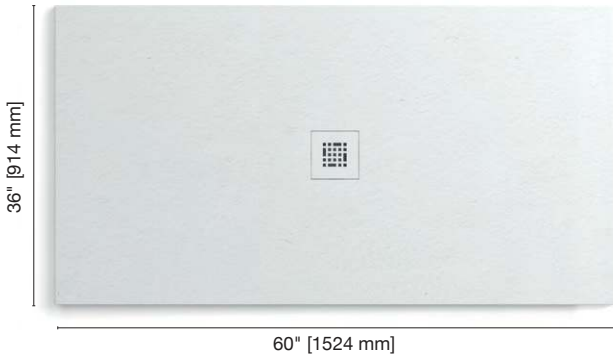

\$1,974.50 stock / en inventaire
\$2,414.50 special order / commande spéciale

Thickness / Épaisseur: 1" [26 mm]
 Weight / Poids: 132 lbs / 60 kg

Code **Stock**

	SSSP60360P Total White / Blanc pur	●
	SSSP603622T Black / Noir	●
	SSSP603636T Cappuccino	●
	SSSP603637T Cement / Ciment	●



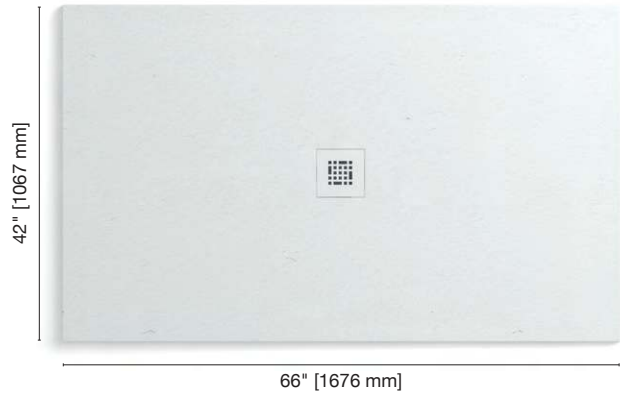

Other color options – special order p.27
 Autres options de couleurs – commande spéciale p.27



\$2,304.50 stock / en inventaire
\$2,854.50 special order / commande spéciale

Thickness / Épaisseur: 1 1/8" [28 mm]
 Weight / Poids: 176 lbs / 80 kg

Code **Stock**

	SSSP66420P Total White / Blanc pur	●
	SSSP664222T Black / Noir	●
	SSSP664236T Cappuccino	●
	SSSP664237T Cement / Ciment	●

Other color options – special order p.27
 Autres options de couleurs – commande spéciale p.27



Quadro

Square centered drain / Drain carré centré

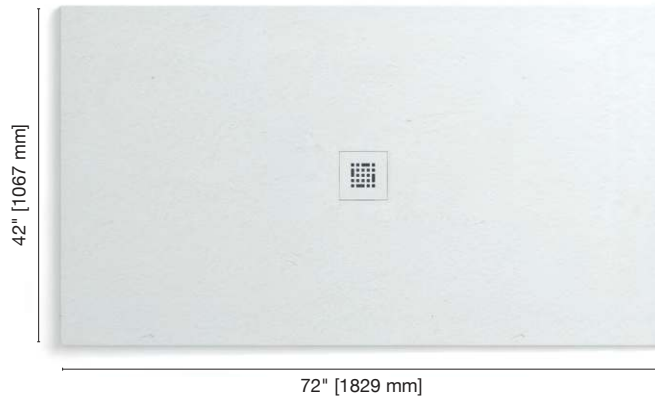

\$2,475 stock / en inventaire
\$3,074.50 special order / commande spéciale

Thickness / Épaisseur: 1 1/8" [28 mm]
Weight / Poids: 198 lbs / 90 kg

Code **Stock**

 **SSSP72420P** ●
Total White / Blanc pur

 **SSSP724222T** ●
Black / Noir

 **SSSP724236T** ●
Cappuccino

 **SSSP724237T** ●
Cement / Ciment

Other color options – special order p.27
Autres options de couleurs – commande spéciale p.27





^ **Quadro SSP36360P**

36" x 36" / 914 x 914 mm
Total White 0P
Blanc pur 0P

Quadro

Square end drain / Drain carré décentré

Easy Tub Replacement Remplacement facile du bain

Before / Avant



After / Après



- Drain located at 9" [229 mm] / Drain situé à 9" [229 mm]
- No drain modification required / Aucune modification de drain nécessaire

Quadro

Square end drain / Drain carré décentré



\$1,644.50 stock / en inventaire
\$2,194.50 special order / commande spéciale

Thickness / Épaisseur: 1^{7/16}" [37 mm]
 Weight / Poids: 130 lbs / 59 kg

Code **Stock**

 **SSSP6030D0P** ●
 Total White / Blanc pur

 **SSSP6030D22T** ●
 Black / Noir

 **SSSP6030D36T** ●
 Cappuccino

 **SSSP6030D37T** ●
 Cement / Ciment

Other color options – special order p.27
 Autres options de couleurs – commande spéciale p.27



\$1,644.50 stock / en inventaire
\$2,194.50 special order / commande spéciale

Thickness / Épaisseur: 1^{7/16}" [37 mm]
 Weight / Poids: 139 lbs / 63 kg

Code **Stock**

 **SSSP6032D0P** ●
 Total White / Blanc pur

 **SSSP6032D22T** ●
 Black / Noir

 **SSSP6032D36T** ●
 Cappuccino

 **SSSP6032D37T** ●
 Cement / Ciment

Other color options – special order p.27
 Autres options de couleurs – commande spéciale p.27



Quadro

Miscellaneous / Divers





Color-match silicone Silicone de couleur assortie

\$33

We recommend the use of our specialized silicone for your FIORA products. Available in the same matching colors.

Nous recommandons l'utilisation de notre silicone spécialisé pour vos produits Fiora. Disponible en couleurs assorties.

Code		Stock
	MASI0P Total White / Blanc pur	●
	MASI22T Black / Noir	●
	MASI36T Cappuccino	●
	MASI37T Cement / Ciment	●

Other color options p.27
 Autres options de couleurs p.27



Drain cover Couvre-drain



Included / Inclus

Drain covers are made of lacquered stainless steel and are supplied with each shower base in the **matching color of the base**. Hook for drain cover removal included.

Fabriqués en acier inoxydable laqué, les couvre-drains sont fournis avec chaque base de douche **dans la couleur assortie**. Crochet pour retirer le couvre-drain inclus.



Option

\$51.70

Brushed stainless steel

Acier inoxydable brossé

Code	Stock
REQU Brushed stainless steel Acier inoxydable brossé	●

Tile flange Bride de carrelage



Included / Inclus

- 2 for long sides and 1 short (included)
- 2 longs et 1 court (inclus)

Characteristics of the Fiora tile flange (approved by IAPMO)

- Extruded in one piece superior quality PVC.
- Special design for better adaptation to the base and to the installation.
- Self-adhesive for quick installation.
- Flexible and easy to cut.
- Additional integrated lip for security.
- No corrosion.

Caractéristiques de la bride de carrelage Fiora (approuvé par IAPMO)

- PVC de qualité supérieure extrudé en une seule pièce.
- Conception spéciale pour une meilleure adaptation de la base à l'installation.
- Autocollant pour une installation rapide.
- Flexible et facile à couper.
- Rebord supplémentaire intégré pour plus de sécurité.
- Pas de corrosion.



Other color options Autres options de couleur



0T Off White Blanc cassé	40T Bone Ivoire	21M Silk Grey Gris soyeux	31T Grey Gris
---------------------------------------	------------------------------	--	----------------------------

These colors are special order
Ces couleurs sont offertes en commande spéciale

Recommended drains (not included) Drains recommandés (non inclus)

Our shower bases can accommodate the majority of standard 2" drains for moulded bases available on the market.

Nos bases de douche peuvent accueillir la majorité des drains traditionnels de 2" pour les bases moulées offertes sur le marché.

Recommended drain models (not included)

Modèles de drains recommandés (non inclus)

SIoux CHIEF: 825-2 (PVC)
OATEY: 42150 (BRASS)
ZURN: FD 2275 (PVC)
OS&B: SD5135 - CP (PVC)
OATEY: 42049 (PVC)
EASTMAN: 15303 (PVC)
OS&B: SD22 (BRASS)
OS&B: SD35 - CP (ABS)





Linea SDLP604222T
60" x 42" / 1524 x 1067 mm
Black color 22T
Couleur Noir 22T



Linea

—
SHOWER BASES - BASES DE DOUCHE



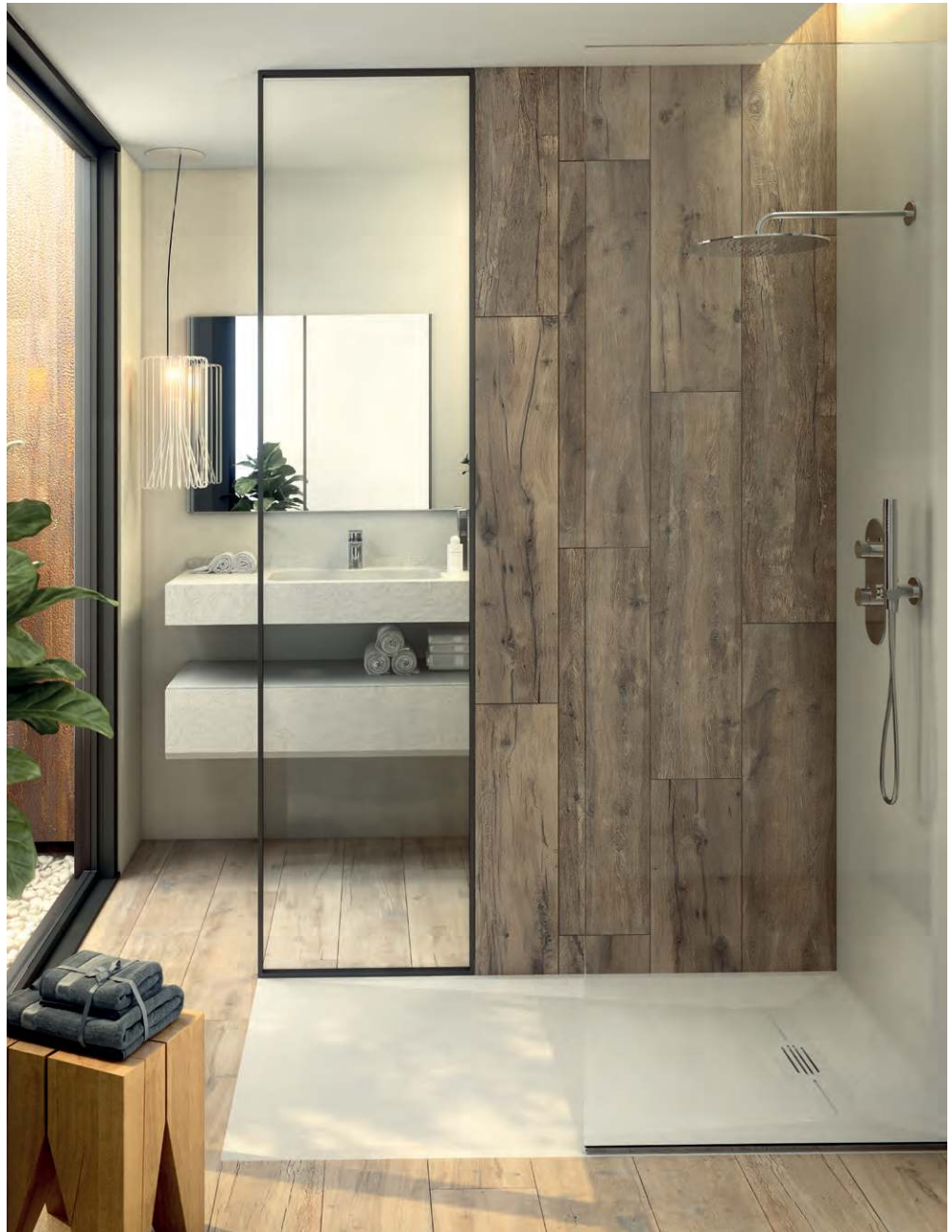

^ **Linea SDTP60360P**

60" x 36" / 1524 x 914 mm
Total White color 0P
Couleur Blanc pur 0P

< **Linea SDTP404036T**

40" x 40" / 1016 x 1016 mm
Cappuccino color 36T
Couleur Cappuccino 36T

Linea

Linear drain / Drain linéaire

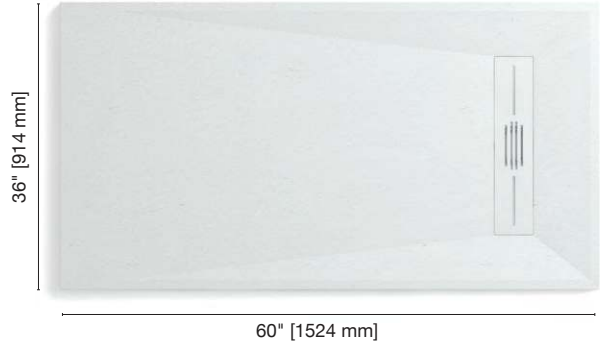
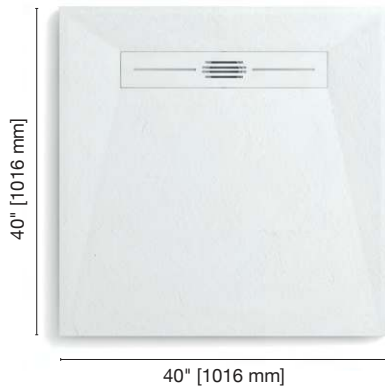

\$1,754.50 stock / en inventaire
\$2,194.50 special order / commande spéciale

Thickness / Épaisseur: 1 5/16" [33 mm]
 Weight / Poids: 112 lbs / 51 kg

\$2,365 stock / en inventaire
\$2,964.50 special order / commande spéciale

Thickness / Épaisseur: 1 1/2" [38 mm]
 Weight / Poids: 165 lbs / 75 kg

Code **Stock**

 **SDTP40400P** ●
 Total White / Blanc pur

 **SDTP404022T** ●
 Black / Noir

 **SDTP404036T** ●
 Cappuccino

 **SDTP404037T** ●
 Cement / Ciment

Other color options – special order p.35
 Autres options de couleurs – commande spéciale p.35



Code **Stock**

 **SDTP60360P** ●
 Total White / Blanc pur

 **SDTP603622T** ●
 Black / Noir

 **SDTP603636T** ●
 Cappuccino

 **SDTP603637T** ●
 Cement / Ciment

Other color options – special order p.35
 Autres options de couleurs – commande spéciale p.35







TECHNICAL FEATURES AND PRICE LIST |
 CARACTÉRISTIQUES TECHNIQUES ET LISTE DE PRIX



\$2,524.50 stock / en inventaire
\$3,184.50 special order / commande spéciale

Thickness / Épaisseur: 1 5/16" [34 mm]
 Weight / Poids: 185 lbs / 84 kg

Code		Stock
	SDLP60420P Total White / Blanc pur	●
	SDLP604222T Black / Noir	●
	SDLP604236T Cappuccino	●
	SDLP604237T Cement / Ciment	●

Other color options – special order p.35
 Autres options de couleurs – commande spéciale p.35



Linea

Miscellaneous / Divers



Color-match silicone Silicone de couleur assortie

\$33

We recommend the use of our specialized silicone for your FIORA products. Available in the same matching colors.

Nous recommandons l'utilisation de notre silicone spécialisé pour vos produits Fiora. Disponible en couleurs assorties.

Code		Stock
------	--	-------

	MASI0P Total White / Blanc pur	●
--	--	---

	MASI22T Black / Noir	●
---	--------------------------------	---

	MASI36T Cappuccino	●
---	------------------------------	---

	MASI37T Cement / Ciment	●
---	-----------------------------------	---

Other color options p.35
 Autres options de couleurs p.35



Drain cover Couvre-drain



Included / Inclus

Drain covers are made of lacquered stainless steel and are supplied with each shower base in the **matching color of the base**. Hook for drain cover removal included.

Fabriqués en acier inoxydable laqué, les couvre-drains sont fournis avec chaque base de douche **dans la couleur assortie**. Crochet pour retirer le couvre-drain inclus.

Option

\$159.50

Brushed stainless steel
 Acier inoxydable brossé

Code		Stock
------	--	-------

RELIL25	For 40" x 40" and 60" x 36" Pour 40" x 40" et 60" x 36"	●
----------------	--	---

\$192.50

Brushed stainless steel
 Acier inoxydable brossé

Code		Stock
------	--	-------

RELIL31	For 60" x 42" Pour 60" x 42"	●
----------------	---------------------------------	---

Tile flange Bride de carrelage



Included / Inclus

- 2 for long sides and 1 short (included)
- 2 longs et 1 court (inclus)

Characteristics of the Fiora tile flange (approved by IAPMO)

- Extruded in one piece superior quality PVC.
- Special design for better adaptation to the base and to the installation.
- Self-adhesive for quick installation.
- Flexible and easy to cut.
- Additional integrated lip for security.
- No corrosion.

Caractéristiques de la bride de carrelage Fiora (approuvé par IAPMO)

- PVC de qualité supérieure extrudé en une seule pièce.
- Conception spéciale pour une meilleure adaptation de la base à l'installation.
- Autocollant pour une installation rapide.
- Flexible et facile à couper.
- Rebord supplémentaire intégré pour plus de sécurité.
- Pas de corrosion.



Other color options Autres options de couleur



0T Off White Blanc cassé	40T Bone Ivoire	21M Silk Grey Gris soyeux	31T Grey Gris
---------------------------------------	------------------------------	--	----------------------------

These colors are special order
Ces couleurs sont offertes en commande spéciale

Recommended drains (not included) Drains recommandés (non inclus)

Our shower bases can accommodate the majority of standard 2" drains for moulded bases available on the market.
Nos bases de douche peuvent accueillir la majorité des drains traditionnels de 2" pour les bases moulées offertes sur le marché.

Recommended drain models (not included)
Modèles de drains recommandés (non inclus)

SIoux CHIEF: 825-2 (PVC)
OATEY: 42150 (BRASS)
ZURN: FD 2275 (PVC)
OS&B: SD5135 - CP (PVC)
OATEY: 42049 (PVC)
EASTMAN: 15303 (PVC)
OS&B: SD22 (BRASS)
OS&B: SD35 - CP (ABS)





Fontana MPC106010P

47 3/8" L x 18 15/16" W x 5 1/8" H
1203 L x 480 W x 130 H mm

Total White color 0P
Couleur Blanc pur 0P



Sinks and vanities
Lavabos et meubles-lavabos

FONTANA - KAPPA
COLLECTIONS



^ **Kappa LAKAPPAG010P**

28 3/8" L X 16 15/16" W X 3 3/16" H
 720 L X 430 W X 80 H mm
 Total White color 0P
 Couleur Blanc pur 0P

Fontana MPC1220122T > ^

63 1/8" L x 18 15/16" W x 5 1/8" H
 1603 L x 480 W x 130 H mm
 Black color 22T
 Couleur Noir 22T

Fontana MPC103010P >

35 9/16" L x 18 15/16" W x 5 1/8" H
 903 L x 480 W x 130 H mm
 Total White color 0P
 Couleur Blanc pur 0P



Fontana

Wall mount sinks / Lavabos muraux

Installation brackets not included, see p.43 / Supports d'installation non inclus, voir p.43

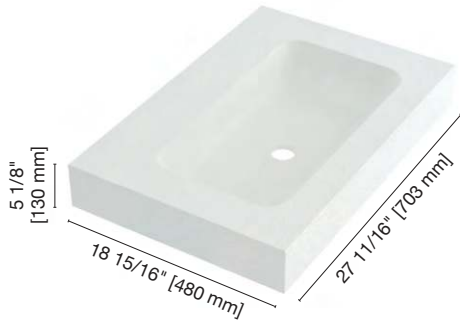

\$2,414.50

Weight / Poids: 42 lbs / 19 kg

Code **Stock**



Total White / Blanc pur

No hole / Aucun trou
 MPCIO1000P
 1 hole / 1 trou
 MPCIO1010P
 3 holes / 3 trous
 MPCIO1030P



Black / Noir

No hole / Aucun trou
 MPCIO10022T
 1 hole / 1 trou
 MPCIO10122T
 3 holes / 3 trous
 MPCIO10322T



Cappuccino

No hole / Aucun trou
 MPCIO10036T
 1 hole / 1 trou
 MPCIO10136T
 3 holes / 3 trous
 MPCIO10336T



Cement / Ciment

No hole / Aucun trou
 MPCIO10037T
 1 hole / 1 trou
 MPCIO10137T
 3 holes / 3 trous
 MPCIO10337T

Other color options p.43
 Autres options de couleurs p.43

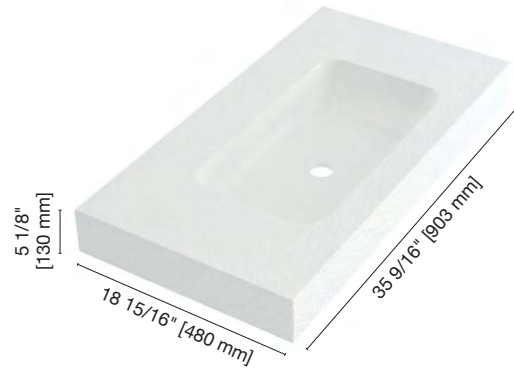

\$2,634.50

Weight / Poids: 51 lbs / 23 kg

Code **Stock**



Total White / Blanc pur

No hole / Aucun trou
 MPCIO3000P ●
 1 hole / 1 trou
 MPCIO3010P ●
 3 holes / 3 trous
 MPCIO3030P ●



Black / Noir

No hole / Aucun trou
 MPCIO30022T ●
 1 hole / 1 trou
 MPCIO30122T ●
 3 holes / 3 trous
 MPCIO30322T ●



Cappuccino

No hole / Aucun trou
 MPCIO30036T
 1 hole / 1 trou
 MPCIO30136T
 3 holes / 3 trous
 MPCIO30336T



Cement / Ciment

No hole / Aucun trou
 MPCIO30037T
 1 hole / 1 trou
 MPCIO30137T
 3 holes / 3 trous
 MPCIO30337T

Other color options p.43
 Autres options de couleurs p.43



TECHNICAL FEATURES AND PRICE LIST |
 CARACTÉRISTIQUES TECHNIQUES ET LISTE DE PRIX

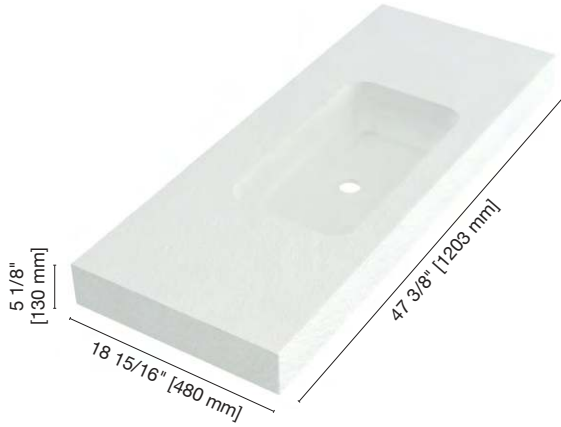

\$2,964.50

Weight / Poids: 62 lbs / 28 kg

Code **Stock**

 **Total White / Blanc pur**
 No hole / Aucun trou
 MPC106000P
 1 hole / 1 trou
 MPC106010P
 3 holes / 3 trous
 MPC106030P

 **Black / Noir**
 No hole / Aucun trou
 MPC1060022T
 1 hole / 1 trou
 MPC1060122T
 3 holes / 3 trous
 MPC1060322T

 **Cappuccino**
 No hole / Aucun trou
 MPC1060036T
 1 hole / 1 trou
 MPC1060136T
 3 holes / 3 trous
 MPC1060336T

 **Cement / Ciment**
 No hole / Aucun trou
 MPC1060037T
 1 hole / 1 trou
 MPC1060137T
 3 holes / 3 trous
 MPC1060337T

Other color options p.43
 Autres options de couleurs p.43





\$3,844.50

Weight / Poids: 86 lbs / 39 kg

Code **Stock**

 **Total White / Blanc pur**
 No hole / Aucun trou
 MPC122000P ●
 1 hole / 1 trou
 MPC122010P ●
 3 holes / 3 trous
 MPC122030P ●

 **Black / Noir**
 No hole / Aucun trou
 MPC1220022T ●
 1 hole / 1 trou
 MPC1220122T ●
 3 holes / 3 trous
 MPC1220322T ●

 **Cappuccino**
 No hole / Aucun trou
 MPC1220036T ●
 1 hole / 1 trou
 MPC1220136T ●
 3 holes / 3 trous
 MPC1220336T ●

 **Cement / Ciment**
 No hole / Aucun trou
 MPC1220037T ●
 1 hole / 1 trou
 MPC1220137T ●
 3 holes / 3 trous
 MPC1220337T ●

Other color options p.43
 Autres options de couleurs p.43



The manufacturer accepts 5 mm (1/4") variance
 Le fabricant accepte une tolérance de 5 mm (1/4")

Kappa

Sinks / Lavabos

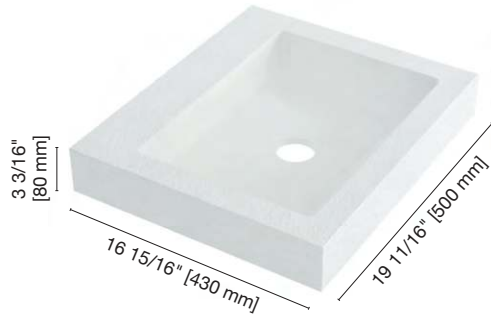

\$1,204.50

Weight / Poids: 40 lbs / 18 kg

Code **Stock**



Total White / Blanc pur

- No hole / Aucun trou
LAKAPPAP000P
- 1 hole / 1 trou
LAKAPPAP010P
- 3 holes / 3 trous
LAKAPPAP030P



Black / Noir

- No hole / Aucun trou
LAKAPPAP0022T
- 1 hole / 1 trou
LAKAPPAP0122T
- 3 holes / 3 trous
LAKAPPAP0322T



Cappuccino

- No hole / Aucun trou
LAKAPPAP0036T
- 1 hole / 1 trou
LAKAPPAP0136T
- 3 holes / 3 trous
LAKAPPAP0336T



Cement / Ciment

- No hole / Aucun trou
LAKAPPAP0037T
- 1 hole / 1 trou
LAKAPPAP0137T
- 3 holes / 3 trous
LAKAPPAP0337T

Other color options p.43
 Autres options de couleurs p.43

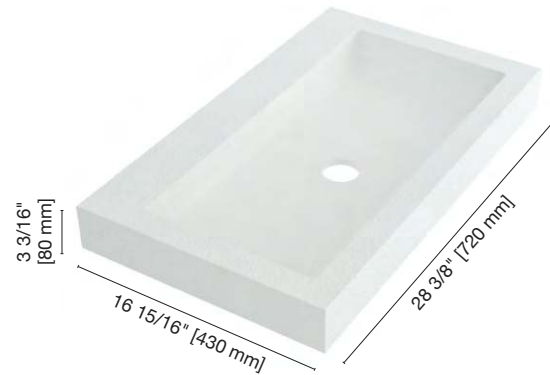

\$1,754.50

Weight / Poids: 53 lbs / 24 kg

Code **Stock**



Total White / Blanc pur

- No hole / Aucun trou
LAKAPPAG000P ●
- 1 hole / 1 trou
LAKAPPAG010P ●
- 3 holes / 3 trous
LAKAPPAG030P ●



Black / Noir

- No hole / Aucun trou
LAKAPPAG0022T ●
- 1 hole / 1 trou
LAKAPPAG0122T ●
- 3 holes / 3 trous
LAKAPPAG0322T ●



Cappuccino

- No hole / Aucun trou
LAKAPPAG0036T
- 1 hole / 1 trou
LAKAPPAG0136T
- 3 holes / 3 trous
LAKAPPAG0336T



Cement / Ciment

- No hole / Aucun trou
LAKAPPAG0037T
- 1 hole / 1 trou
LAKAPPAG0137T
- 3 holes / 3 trous
LAKAPPAG0337T

Other color options p.43
 Autres options de couleurs p.43



Fontana / Kappa

Miscellaneous / Divers



Color-match silicone Silicone de couleur assortie

\$33

We recommend the use of our specialized silicone for your FIORA products. Available in the same matching colors.

Nous recommandons l'utilisation de notre silicone spécialisé pour vos produits Fiora. Disponible en couleurs assorties.

Code	Stock
 MASI0P Total White / Blanc pur	●
 MASI22T Black / Noir	●
 MASI36T Cappuccino	●
 MASI37T Cement / Ciment	●

Other color options p.43
 Autres options de couleurs p.43



Other color options Autres options de couleur



0T Off White Blanc cassé	40T Bone Ivoire	21M Silk Grey Gris soyeux	31T Grey Gris
---------------------------------------	------------------------------	--	----------------------------

These colors are special order
 Ces couleurs sont offertes en commande spéciale

Fontana

Brackets for installation are not included.

Compatibles models:

ZURN Z 1236, VOSAM 17380, WATTS CA-401

Les supports pour l'installation ne sont pas inclus.

Modèles compatibles:

ZURN Z 1236, VOSAM 17380, WATTS CA-401



NEW
NOUVEAUTÉ



Shower panels Panneaux de douche

MURO
COLLECTION



Harmonize
color & texture

WITH OUR NEW MURO PANELS

Agencez
couleur & texture

AVEC NOS NOUVEAUX PANNEAUX MURO

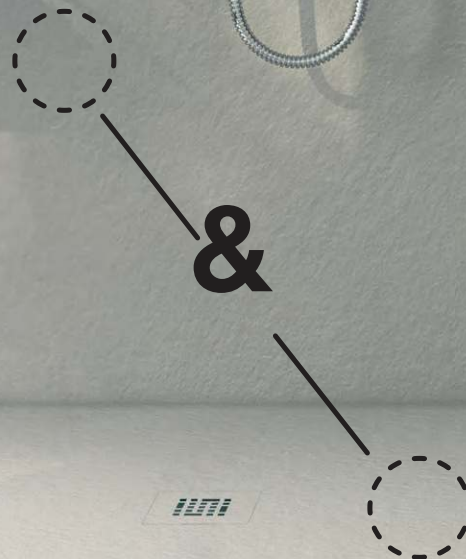

Quick and Easy Installation Installation simple et rapide

Renovation or new construction
Rénovation ou nouvelle construction



Silexpol / Polyurethane with Nanobath technology

Silexpol / Polyuréthane avec technologie Nanobath

All Fiora wall panels are made of our patented Silexpol material and quality polyurethane for the most performing shower panels.

Tous les panneaux de douche Fiora sont fabriqués en Silexpol, un matériau breveté, et en polyuréthane de qualité afin d'offrir les panneaux de douche les plus performants.



Customizable.
Personnalisable.



100% waterproof.
100% imperméable.



Easy and fast
installation.
Installation simple
et rapide.



Easier cleaning.
Entretien plus facile.

CUT TO SIZE ON JOB SITE
DÉCOUPEZ SUR MESURE AU CHANTIER

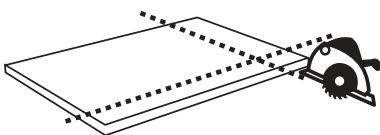

Cut with a diamond blade / Coupez avec une lame de diamant

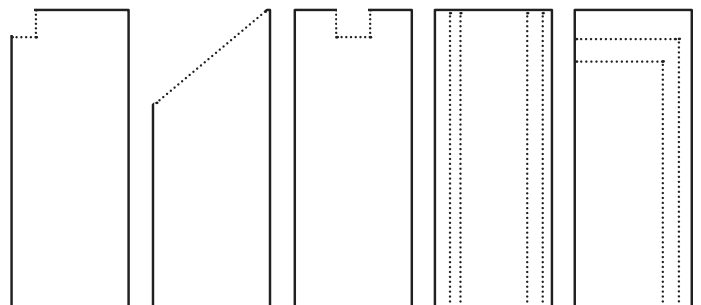





^ **Muro**

Total White color 0P
Couleur Blanc pur 0P

< **Muro**

Grey color 31T
Couleur Gris 31T

Muro

Shower panels / Panneaux de douche



\$1,314.50

Thickness / Épaisseur: 1/4" [6 mm]
Weight / Poids: 28.6 lbs / 13 kg

Code **Stock**



SPV702400P
Total White / Blanc pur



SPV7024022T
Black / Noir



SPV7024036T
Cappuccino



SPV7024037T
Cement / Ciment

Other color options p.53
Autres options de couleurs p.53



TECHNICAL FEATURES AND PRICE LIST |
 CARACTÉRISTIQUES TECHNIQUES ET LISTE DE PRIX





\$1,534.50
 Thickness / Épaisseur: 1/4" [6 mm]
 Weight / Poids: 33 lbs / 15 kg

\$1,754.50
 Thickness / Épaisseur: 1/4" [6 mm]
 Weight / Poids: 37.5 lbs / 17 kg

Code **Stock**

 **SPV752400P** ●
 Total White / Blanc pur

 **SPV7524022T** ●
 Black / Noir

 **SPV7524036T**
 Cappuccino

 **SPV7524037T**
 Cement / Ciment

Other color options p.53
 Autres options de couleurs p.53



Code **Stock**

 **SPV902400P** ●
 Total White / Blanc pur

 **SPV9024022T** ●
 Black / Noir

 **SPV9024036T**
 Cappuccino

 **SPV9024037T**
 Cement / Ciment

Other color options p.53
 Autres options de couleurs p.53













Muro / Quadro

Ordering Chart / Charte de commande

Shower base size Format de la base de douche	Walls to cover Murs à habiller	SPV70240 24" x 94 ^{1/2} "	SPV75240 30" x 94 ^{1/2} "	SPV90240 36" x 94 ^{1/2} "
Quadro SSP3636 36" x 36"	1 	—	—	1
	2 	—	—	2
	3 	—	—	3
Quadro SSP4836 48" x 36"	1 	2	—	—
	1 	—	—	1
	2 	2	—	1
	3 	2	—	2
Quadro SSP6036 60" x 36"	1 	—	2	—
	1 	—	—	1
	2 	—	2	1
	3 	—	2	2
Quadro SSP6642 66" x 42"	1 	—	1	1
	1 	2 (Cut to size / Couper au format)	—	—
	2 	2 (Cut to size / Couper au format)	1	1
	3 	4 (Cut to size / Couper au format)	1	1
Quadro SSP7242 72" x 42"	1 	—	—	2
	1 	2 (Cut to size / Couper au format)	—	—
	2 	2 (Cut to size / Couper au format)	—	2
	3 	4 (Cut to size / Couper au format)	—	2
Quadro SSP6030D 60" x 30"	1 	—	2	—
	1 	—	1	—
	2 	—	3	—
	3 	—	4	—
Quadro SSP6032D 60" x 32"	1 	—	2	—
	1 	—	—	1 (Cut to size / Couper au format)
	2 	—	2	1 (Cut to size / Couper au format)
	3 	—	2	2 (Cut to size / Couper au format)

Muro / Linea

Ordering Chart / Charte de commande

Shower base size Format de la base de douche	Walls to cover Murs à habiller	SPV70240 24" x 94 ^{1/2} "	SPV75240 30" x 94 ^{1/2} "	SPV90240 36" x 94 ^{1/2} "
Linea SDTP4040 40" x 40"	1 	2 (Cut to size / Couper au format)	—	—
	2 	4 (Cut to size / Couper au format)	—	—
	3 	6 (Cut to size / Couper au format)	—	—
Linea SDTP6036 60" x 36"	1 	—	2	—
	1 	—	—	1
	2 	—	2	1
	3 	—	2	2
Linea SDTP6042 60" x 42"	1 	—	2	—
	1 	2 (Cut to size / Couper au format)	—	—
	2 	2 (Cut to size / Couper au format)	2	—
	3 	4 (Cut to size / Couper au format)	2	—

Muro

Miscellaneous / Divers





Color-match silicone Silicone de couleur assortie



\$33

We recommend the use of our specialized silicone for your FIORA products. Available in the same matching colors.

Nous recommandons l'utilisation de notre silicone spécialisé pour vos produits Fiora. Disponible en couleurs assorties.

Code	Stock
 MASI0P Total White / Blanc pur	●
 MASI22T Black / Noir	●
 MASI36T Cappuccino	●
 MASI37T Cement / Ciment	●

Other color options (p.53)
Autres options de couleurs (p.53)

Other color options Autres options de couleur



0T
Off White
Blanc cassé



40T
Bone
Ivoire



21M
Silk Grey
Gris soyeux



31T
Grey
Gris

These colors are special order
Ces couleurs sont offertes en commande spéciale

The manufacturer accepts 5 mm (1/4") variance
Le fabricant accepte une tolérance de 5 mm (1/4")

Spare parts

Pièces de rechange



Adhesive for tile flange corner sealing (2 units)
Adhésif pour le joint d'angle de la bride de carrelage (2 unités)

\$11

Code **Stock**

36403A3040 ●
White / Blanc



Tile flange 36"
Bride de carrelage 36"

\$33

Code **Stock**

36403A3036_915 ●
White / Blanc



Tile flange 60"
Bride de carrelage 60"

\$44

Code **Stock**

36403A3036_1524 ●
White / Blanc



Tile flange 72"
Bride de carrelage 72"

\$55

Code **Stock**

36403A3036_1829 ●
White / Blanc



Brushed stainless steel finish drain cover for Quadro
Couvre-drain en acier inoxydable brossé pour Quadro

\$51.70

Code **Stock**

REQU ●
Brushed stainless steel
Acier inoxydable brossé



Lacquered stainless steel drain cover for Quadro
Couvre-drain en acier inoxydable laqué pour Quadro

\$51.70

Code **Stock**

REQU ●
Indicate color code
Code couleur à indiquer



25" brushed stainless steel finish drain cover for Linea
Couvre-drain de 25" en acier inoxydable brossé pour Linea

\$159.50

Code **Stock**

RELIL25 ●
Brushed stainless steel
Acier inoxydable brossé



25" lacquered stainless steel drain cover for Linea
Couvre-drain de 25" en acier inoxydable laqué pour Linea

\$1159.50

Code **Stock**

RELIL25L ●
Indicate color code
Code couleur à indiquer



31" brushed stainless steel finish drain cover for Linea
Couvre-drain de 31" en acier inoxydable brossé pour Linea

\$192.50

Code **Stock**

RELIL31 ●
Brushed stainless steel
Acier inoxydable brossé



31" lacquered stainless steel drain cover for Linea
Couvre-drain de 31" en acier inoxydable laqué pour Linea

\$192.50

Code **Stock**

RELIL31L ●
Indicate color code
Code couleur à indiquer



Vanity door hinge for 9 mm hole
Charnière de porte de meuble pour trou de 9 mm

\$55

Code **Stock**

3401A1006 ●



Soft close system for hinge
Système de fermeture lente pour charnière

\$27.50

Code **Stock**

SFB ●

TECHNICAL FEATURES AND PRICE LIST |
 CARACTÉRISTIQUES TECHNIQUES ET LISTE DE PRIX



Color touch-up – small
 Retouche couleur – petit

\$38.50

Code **Stock**

KIT_REP
 Indicate color code
 Code couleur à indiquer



Color touch-up – large
 Retouche couleur – grand

\$88

Code **Stock**

LACA
 Indicate color code
 Code couleur à indiquer



Filler
 Remplisseur

\$11

Code **Stock**

PLASTE



Hook for drain cover
 Crochet pour couvre-drain



\$11

Code **Stock**

RP210



PRODUCT USAGE
UTILISATION DES PRODUITS

Product / Produit	Usage / Utilisation
 <p>KIT REP Color touch-up – small Retouche couleur – petit</p>	<p>Color touch-up for small surfaces Retouche couleur pour une petite surface</p>
 <p>LACA Color touch-up – large Retouche couleur – grand</p>	<p>Color touch-up for large surfaces Retouche couleur pour une grande surface</p>
 <p>PLASTE Filler Remplisseur</p>	<p>To fill a chip in the material (color touch-up not included) Pour combler un trou ou une rainure (retouche couleur non incluse)</p>

The tile flange installation

Installation de la bride de carrelage

01

Preparation of the elements, fix tile flange to the base.

Préparation des éléments, fixer la bride de carrelage à la base de douche.

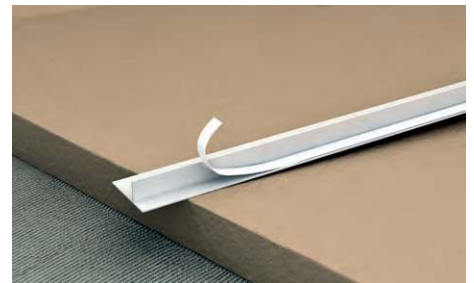

02

Add the adhesive to seal the tile flange's corner.

Ajouter l'adhésif pour sceller les coins de la bride de carrelage.

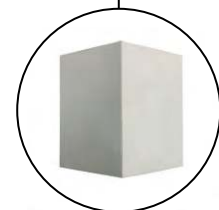
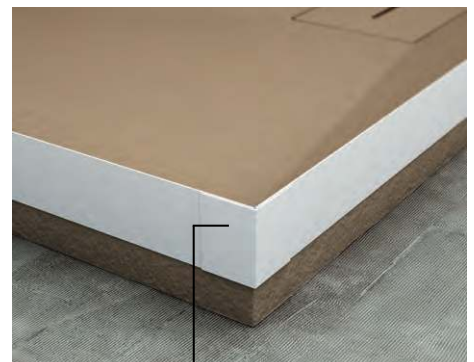

03

Place base in its position.
Mettre en place la base de douche.



04

Finished result.
Résultat final.



**Characteristics of the Fiora tile flange
(approved by IAPMO)**

- Extruded in one piece superior quality PVC.
- Special design for better adaptation to the base and to the installation.
- Self-adhesive for quick installation.
- Flexible and easy to cut.
- Additional integrated lip for security.
- No corrosion.

**Caractéristiques de la bride de carrelage Fiora
(approuvé par IAPMO)**

- PVC de qualité supérieure extrudé en une seule pièce.
- Conception spéciale pour une meilleure adaptation de la base à l'installation.
- Autocollant pour une installation rapide.
- Flexible et facile à couper.
- Rebord supplémentaire intégré pour plus de sécurité.
- Pas de corrosion.

General specifications

CONDITIONS OF USE AND MAINTENANCE

SHOWER BASES AND FONTANA COLLECTION

By following these recommendations, you will enjoy your FIORA products for many years to come.

For routine cleaning (after showering), rinse the shower base and wall panels and ensure that the bathroom area has proper ventilation.

For thorough cleaning, rinse the shower base/panel with water and use a wet cloth or a non-abrasive sponge with any available commercial bathroom cleaning product. Avoid using cleaning products or disinfectants that contain alcohol. Abrasive products (scouring pads, rough rags or other similar items) should not be used, since they can damage the shower base surface.

Limescale-resistant sprays or other similar shower cleaning products can be used for maintenance. These products should be applied directly to the shower base and then rinsed – recommended for locations that have a very hard water supply (with high levels of limescale).

FURNITURE

Front and sides of furniture

Made with highly moisture resistant materials with zero absorption capacity so that they can be cleaned with a cloth moistened in water or any general cleaning product available at any supermarket. **DO NOT USE PRODUCTS THAT CONTAIN SOLVENTS OR ABRASIVE ELEMENTS FOR CLEANING.**

Sinks

For routine cleaning, rinse the surface with water after use.

For deeper cleaning, rinse the surface with water and use a wet cloth or a non-abrasive sponge with any available domestic bathroom cleaning product. Avoid using cleaning products or disinfectants that contain alcohol. Abrasive products (scouring pads, rough rags or other similar items) should not be used, since they can damage the surface of the sinks.

Limescale-resistant sprays or other similar shower cleaning products can be used for maintenance. These products should be applied directly to the sink and then rinsed – recommended for locations that have a very hard water supply (with high levels of limescale).

IT IS VERY IMPORTANT TO SEAL THE ENTIRE PERIMETER OF THE COUNTERTOP ADJACENT TO THE FURNITURE IN ORDER TO PREVENT WATER COMING INTO CONTACT WITH THE PARTS OF THE FURNITURE MADE OF MDF. MAKE SURE THAT THE INSTALLER CAREFULLY FOLLOWS THESE INSTRUCTIONS WHEN PERFORMING THIS OPERATION.

ATTENTION: The use of dyes, acids or solvent products, such as universal solvents, turpentine, or acetone may damage and/or alter the color coating if they exceed the maximum exposure time limits explained on the product table.

PRODUCTS EFFECT TESTS

In our everyday life we use many products that, at one moment or another, can come into contact with the products that FIORA BATH COLLECTIONS, S.L. makes. For this reason our R+D+i Department subjects all our materials to different tests to determine the level of incidence, the durability and the resistance of them when faced with the possible effects of these products.

These tests are always conceived and carried out from a practical point of view, using real products that we can find at any supermarket. However, the application conditions on the FIORA™ article are much more severe than what would happen within normal conditions of use.

The results obtained are shown on the next table using real SILEXPOL samples.

Product tested	Exposure time	SILEXPOL deterioration
Wine vinegar	8 h	A
Bleach	1 h	A
Window cleaning agent	8 h	A
Iodine	1 min	B
General cleaner (<5% anionic surfactants)	8 h	A
Degreasing agent (< 5% anionic surfactant agents and polycarboxylates and 5%-15% non-ionic surfactant agents)	8 h	A
Limescale remover	8 h	A
Hair dye (medium colour)	1 min	B
Hair dye (dark colour)	1 min	D
Vegetable oil for human consumption	8 h	A
Makeup remover liquid	8 h	A
Acetone	1 min	A
Alcohol 96°	8 h	A
Hydrogen peroxide	8 h	A
Merbromin	1 min	B
Organic solvent	1 min	A
Fruit juice	8 h	A
Coffee	8 h	A
Red wine	8 h	A
Lipstick	8 h	A
Ammonia	8 h	A
Ink	8 h	A
Permanent marker	8 h	A
Pen	8 h	A
Pencil	8 h	A
Hydrochloric acid solution	1 h	B

The classification used corresponds to the following codes:

A: Without important visible changes. B: Slight change of colour. C: Moderate change in colour. D: Significant change in colour. E: Layer etched.

Notes générales

CONDITIONS D'UTILISATION ET D'ENTRETIEN

BASES DE DOUCHE ET COLLECTION FONTANA

En suivant ces recommandations, vous pourrez profiter de vos produits FIORA™ pendant plusieurs années.

Pour un nettoyage quotidien (après votre douche) il suffit de rincer la base de douche et le panneau de douche avec de l'eau tout en assurant une aération suffisante de la salle de bain.

Pour un nettoyage en profondeur, rincer la base/panneau de douche avec de l'eau et un nettoyant pour salle de bain du commerce et nettoyer avec un chiffon ou une éponge non abrasive. Il est préférable d'éviter l'utilisation de nettoyants ou de désinfectants contenant de l'alcool. Les produits abrasifs (éponges à récurer, chiffons ou semblables) ne sont pas adéquats non plus, puisqu'ils pourraient endommager la surface.

Pour l'entretien, vous pouvez utiliser des produits en spray anti-calcaire pour la douche ou autres similaires. Ces produits doivent être appliqués sur la base de douche et être rincés ensuite, leur utilisation est recommandée dans les zones ou les localités aux eaux très dures (à haute teneur en calcaire).

MOBILIER

Devanture et côtés des meubles

Il s'agit de matériaux hautement résistants à l'humidité dont la capacité d'absorption est nulle, ce pourquoi ils peuvent être nettoyés en utilisant un chiffon humecté d'eau ou un nettoyant tout usage offert dans les supermarchés. **POUR LE NETTOYAGE VEUILLEZ NE PAS UTILISER DE PRODUITS CONTENANT DES SOLVANTS OU DES ÉLÉMENTS ABRASIFS.**

Lavabos

Pour un nettoyage quotidien, rincer la surface avec de l'eau.

Pour un nettoyage en profondeur, rincer la surface avec de l'eau et un nettoyant domestique pour salle de bain et nettoyer avec un chiffon ou une éponge non abrasive. Il est préférable d'éviter l'utilisation de nettoyants ou de désinfectants contenant de l'alcool. Les produits abrasifs (éponges à récurer, chiffons ou semblables) ne sont pas adéquats non plus, puisqu'ils pourraient endommager la surface.

Pour l'entretien, vous pouvez utiliser des produits en spray anti-calcaire pour la douche ou autres similaires. Ces produits doivent être appliqués sur le lavabo et être rincés ensuite, leur utilisation est recommandée dans les zones ou les localités aux eaux très dures (à haute teneur en calcaire).

IL EST TRÈS IMPORTANT DE SCELLER TOUT LE PÉRIMÈTRE DU PLAN DE TRAVAIL EN CONTACT AVEC LE MEUBLE AFIN D'ÉVITER LE CONTACT DE L'EAU AVEC LES PARTIES DU MEUBLE EN MDF. VEILLENZ À CE QUE L'INSTALLATEUR AIT EFFECTUÉ CETTE OPÉRATION SELON NOS INSTRUCTIONS.

ATTENTION: L'utilisation de teintures, d'acides ou de solvants, tels que le dissolvant universel, l'essence de térébenthine ou l'acétone, peuvent endommager le recouvrement en couleur et/ou le modifier, si les temps d'exposition limites expliqués sur le tableau des produits sont dépassés.

TESTS DE RÉSISTANCE AUX PRODUITS

Dans notre vie quotidienne, nous utilisons de nombreux produits qui, un jour ou l'autre, peuvent entrer en contact avec les produits que FIORA BATH COLLECTIONS, S.L. fabrique. C'est pour cela que notre Département RDI soumet tous nos matériaux à différents essais qui détermineront le niveau d'incidence, la durabilité et la résistance de nos matériaux face à un éventuel contact avec ces produits.

Ces essais sont toujours conçus et menés à bien d'un point de vue pratique, en utilisant des produits concrets, que nous pouvons trouver dans n'importe quel supermarché. Cependant, les conditions d'application sur l'article FIORA™ sont beaucoup plus sévères par rapport à une utilisation dans des conditions d'usage normales.

Nous présentons ci-contre les résultats obtenus sur des échantillons concrets de SILEXPOL.

Produit testé	Temps d'exposition	Dégradation SILEXPOL
Vinaigre de vin	8 h	A
Eau de Javel	1 h	A
Nettoyant à vitres	8 h	A
Iode	1 min	B
Nettoyant générique (<5 % tensioactifs anioniques)	8 h	A
Dégraissant (< 5 % tensioactifs anioniques et polycarboxylates et 5 %-15 % tensioactifs non ioniques)	8 h	A
Anticalcaire	8 h	A
Teinture cheveux (couleur moyenne)	1 min	B
Teinture cheveux (couleur foncée)	1 min	D
Huile végétale alimentaire	8 h	A
Liquide démaquillant	8 h	A
Acétone	1 min	A
Alcool à 96°	8 h	A
Peroxyde d'hydrogène	8 h	A
Mercurochrome	1 min	B
Dissolvant organique	1 min	A
Jus de fruit	8 h	A
Café	8 h	A
Vin rouge	8 h	A
Rouge à lèvres	8 h	A
Ammoniaque	8 h	A
Encre	8 h	A
Feutre indélébile	8 h	A
Stylo bille	8 h	A
Crayon de plomb	8 h	A
Eau forte (dilution d'acide chlorhydrique)	1 h	B

Correspondance des codes de dégradation :

A: Sans changement visible notable B: Léger changement de couleur

C: Changement de couleur modéré D: Changement de couleur significatif

E: Surface endommagée

Frequently asked questions

PRODUCT

What material are the drain covers made of?

Drain covers are made of AISI 316 stainless steel cut using high definition laser with a brushed finish on both sides.

The lacquered drain covers are manufactured in AISI 430 stainless steel with a coat of primer of epoxy oven-cured paint, plus the finishing coat in the colour requested.

What are the downward slopes of the bases?

The design of the bases and the subsequent manufacture of the moulds has, as one of the most relevant factors, the objective of providing the base with slopes which enable draining the water quickly at a minimum rate of 0.132 gallons/second (0,6 litres/second)

Depending on the dimensions and the model, these slopes fluctuate between a minimum of 2% to a maximum of 4%, depending on the drain position.

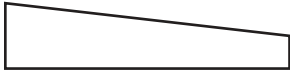

Slope: between 2% and 4%

What are the base thicknesses?

This varies depending on the base model. See technical sheets at fiora.us for further information.

Are there technical diagrams for products in this catalog?

You can find technical data sheets and instructions at www.fiora.us

Can I order spare parts?

AD WATERS has a stock of spare parts. Ask for a quotation from our customer service or see spare parts section of this catalog for those you require.

Can we drill on the base?

Our recommendation is not to do it. Screwing to the base other materials that have a different dilatation and contraction coefficients could lead to a crack. It is better to use silicone for this purpose as this type of adhesive has certain grade of elasticity.

What material are the shower base and sinks made out of?

All our bases and sinks are manufactured from moulds using our patented material SILEXPOL (Patent 2.434.591). It is a highly resistant material composed of a homogeneous mixture of silicas and other minerals conglomerated with a polymer. It is, in short, an anti-slip product that, visually, barely gets stained, with a density of 1,9 kg/dm³ and an absorption coefficient of 0,01%. Its impact resistance is similar to the average of natural stone and is also very resistant to bending, which prevents breakages.

INSTALLATION

What tool should I use to cut the bases?

The bases must be cut with a circular saw equipped with a diamond disc blade, similar to those used to cut stone, tiles, bricks, etc.

NOTE 1: In all edges cut, the texture will disappear leaving smooth surface (without texture) after cutting.

NOTE 2: For cuts close to the drain cover, the minimum distance that should be left from the drain cover to the closest edge is 10" (250 mm).

What material should I use to secure the base in place?

The gluing and/or sealing of the various parts will be done using a caulk sealant. These types of products are also usually used in expansion joints with little movement, sanitary fittings, reinforcement adhesive, door and window frames.

Is it necessary to waterproof underneath the base?

No. The shower bases are 100% waterproof and they do not allow water to leak. Except for specific construction regulations, they do not require membranes, or similar, to be placed underneath. This is one of their main advantages in comparison with tiled shower floors.

Is the drain included with the shower base?

No, as the majority of the existing ones on the market fits with our bases. Refer to the technical specifications for recommended models.

Is the drain included with the sink?

No, as most faucets are supplied with a drain. The drain hole fits all the existing drains on the market.

MAINTENANCE

Will the surface of the shower base and sink become easily dirty because of the texture?

No, as our special METALFACE treatment prevents this issue.

Is the surface of SILEXPOL products solid? Will it scratch easily?

The surface finish is very resistant to scratching, but obviously can be damaged if our installation or normal use procedures are not taken into consideration. This material has the advantage that it can be easily repaired in case of scratches.

Is it possible to repair SILEXPOL components?

FIORA™ articles, which are made in Silexpol, can be repaired if they have not been used properly. Surface top coat scratches and even chipped areas can be easily repaired. Contact AD WATERS customer service to order a repair kit and see the spare parts section of this catalogue for code and pricing. See www.fiora.us for more details.

Foire aux questions

PRODUIT

En quel matériau sont fabriqués les couvre-drains ?

Les couvre-drains sont en acier inoxydable AISI 316 et ils sont découpés au laser haute définition. Les deux faces ont un fini brossé.

Les couvre-drains laqués sont fabriqués en acier inoxydable AISI 430 avec une première couche de peinture époxy au four, plus une couche de finition dans la couleur spécifiée.

Quelle est la pente des bases de douche ?

Les bases de douche ont été conçues avec une pente qui permet d'évacuer rapidement l'eau, à raison d'un minimum de 0,6 litre/seconde.

Ces dénivelés dépendent des dimensions et du modèle de la base de douche ainsi que de l'emplacement du drain. Ils varient entre un minimum de 2 % jusqu'à un maximum de 4 %.



Pente: entre 2 % et 4 %

Quelle est l'épaisseur des bases de douche ?

Cela varie en fonction du modèle de la base de douche. Voir les pages techniques à www.fiora.us pour obtenir plus d'information.

Existe-t-il des schémas techniques pour les bases de douche ?

Oui, vous pouvez les télécharger à www.fiora.us

Puis-je commander des pièces de rechange ?

AD WATERS conserve un stock de pièces de rechange. Demandez un devis à notre service à la clientèle.

Peut-on percer la base de douche ?

Nous ne le recommandons pas. Visser d'autres matériaux à la base de douche (par exemple une porte de douche) dont le coefficient de dilatation et contraction diffère de celui de la base de douche pourrait conduire à des fissures à long terme. Il est préférable d'utiliser un produit silicone à cet effet, ce type de colle présentant une certaine élasticité.

Dans quel matériau les bases de douche et les lavabos sont-ils fabriqués ?

Tous nos lavabos sont fabriqués à l'aide de moules en utilisant notre matériau breveté SILEXPOL (brevet 2.434.591). Il s'agit d'un matériau hautement résistant, composé d'un mélange homogène de silices et d'autres minéraux conglomérés avec un polymère. En résumé, il s'agit d'un produit antidérapant qui est très résistant aux taches, présentant une densité de 1,9 kg/dm³ et un coefficient d'absorption de 0,01 %. La résistance aux chocs est similaire à la moyenne de la pierre naturelle et il est également particulièrement résistant à la flexion, prévenant ainsi les bris.

INSTALLATION

Quel outil dois-je utiliser pour couper les bases de douche ?

Les bases de douche doivent être découpées avec une scie circulaire munie d'une lame diamant, semblable à celles utilisées pour la découpe de la pierre, des carreaux de carrelage, des briques, etc.

NOTE 1 : Sur tous les angles découpés, la texture disparaît, laissant la surface lisse après la réalisation de la découpe.

NOTE 2 : Pour les découpes proches du couvre-drain, une distance minimale de 250 mm doit être laissée entre le couvre-drain et le côté le plus près.

Quel matériau dois-je utiliser pour coller les bases de douche ?

Le collage et/ou l'étanchéité des différents éléments est effectué en utilisant du mastic. Ce type de produit s'utilise aussi pour des joints de dilatation qui bougent peu, des équipements sanitaires, pour coller des revêtements, des cadres de porte et de fenêtres.

Est-il nécessaire d'imperméabiliser sous la base de douche ?

Non. Les bases de douche sont 100 % étanches et ne permettent pas le passage de l'eau. Sauf si les normes locales de construction le requièrent, elles ne nécessitent pas la pose de membrane ou similaire en dessous. C'est un de leurs principaux avantages par rapport aux douches en carrelage.

Le drain est-il livré avec la base de douche ?

Non, la plupart des drains offerts sur le marché étant compatibles avec nos bases de douche. Reportez-vous aux pages techniques afin de suivre nos recommandations.

Le drain est-il livré avec le lavabo ?

Non, puisque la plupart des robinets sont livrés avec un drain. Le trou du drain étant standard, il s'adapte à tous les drains offerts sur le marché.

ENTRETIEN

Les surfaces de la base de douche et du lavabo se salissent-elles facilement compte tenu de leur texture ?

Non, car notre traitement spécial METALFACE prévient ce problème.

La surface des produits SILEXPOL est-elle solide ? Est-ce qu'elle se raye facilement ?

La finition de la surface est particulièrement résistante aux rayures, mais elle peut évidemment être endommagée si nos recommandations lors de l'installation ou de l'utilisation normale ne sont pas respectées. Toutefois, ce matériau présente un grand avantage : il est facile à réparer en cas de rayures.

Est-il possible de réparer les produits faits en SILEXPOL ?

Les articles FIORA™ fabriqués à partir de Silexpol peuvent être réparés en cas de mauvaise utilisation. Ainsi, les zones qui présentent des égratignures de surface peuvent être retouchées, de même que les zones qui comportent des trous (provoqués par exemple par la chute d'objets pointus). Pour plus de détails, voir www.fiora.us

Warranty Garantie

This document explains the warranty for products purchased from FIORA BATH COLLECTIONS, S.L.U., according to the conditions described below:

1. The WARRANTY allows FIORA BATH COLLECTIONS, S.L.U., to either repair or replace the product in accordance with what is deemed the best solution for the defective product. This warranty applies to product sold by an authorized retailer within the territory of the **United States of America and Canada**. Sales made outside the **United States and Canada** are not included within the scope of this warranty unless expressly agreed by FIORA BATH COLLECTIONS, S.L.U.
2. **This warranty does not cover labor and shipping charges, or damages whatever incurred in the whole or in part from installation, removal, re-installation, repair or replacement of any FIORA BATH COLLECTIONS, S.L.U. product or part, as well as any incidental or consequential damages, expenses, losses, direct or indirect, arising from any cause whatsoever.**
3. **The duration of the warranty is 5 years** from the invoice or receipt date of the purchase or, if applicable, the delivery not if its date were after of the aforementioned documents. If the product was a display or demonstration model for the retailer the warranty will only be applicable for one year
4. FIORA BATH COLLECTIONS, S.L.U. guarantees its products and components against any manufacturing defect, provided that they have been correctly installed (in compliance with the standard in force and the instructions indicated for their assembly, maintenance and conservation) and that they have been used correctly and as their design intended.
5. Consumable articles (rubber elements, gaskets, etc.) are not covered by this warranty.
6. The following is excluded from this WARRANTY:
 - a. Damage resulting from transport.
 - b. Damage resulting from incorrect installation, handling or repairs performed by staff not authorized by FIORA BATH COLLECTIONS, S.L.U., as well as damage due to natural wear, poor treatment, and use and maintenance which is incorrect, unsuitable, abnormal or different from usual and/or to that indicated in the relevant instructions.
 - c. Damage caused by dirt, limescale and other physical, chemical or electrochemical defects.
 - d. **Damage or loss sustained in any natural calamity such as fire, earthquake, flood, thunder, electrical storm, etc.**
 - e. Damage which, viewed objectively, cannot be attributed to the manufacturer.
 - f. In case of shower base and panels for tiling, check the dimensions, color etc. prior to installation. No claims will be accepted for these reasons once installed.
 - g. In the case of shower bases, prior to completing the floor tiling and fitting any other element on the shower bases, **the installer must check that the installation is correct and verify that the base drains perfectly. Should this verification not be done correctly**, FIORA BATH COLLECTIONS, S.L.U. will not bear the costs resulting from replacing the elements fitted on the bases such as shower screens or ceramics.
7. **Modifications done to the shower base and wall panels: shower bases and wall panels cut on-site by client or installer are covered under this WARRANTY as long as they follow and respect FIORA BATH COLLECTIONS, S.L.U. installation instructions. Please refer to the installation instructions of your shower base or wall panels for specifications and restrictions related to on-site cuts. If the installation instructions have not been followed, the WARRANTY will automatically be voided.**
8. This warranty is extended to the first purchaser at retail and is not transferable. The original sales receipt must be available to exercise the warranty.
9. For any questions or warranty service requests, please contact FIORA's North American distributor, AD WATERS:

AD WATERS CANADA:

QC and Ottawa region: 1 888 ADW 9336 or tech@ad-waters.com
Western Canada, Ontario and Maritimes: 1 888 ADW 9336 or techtoronto@ad-waters.com
U.S.A.: 1 888 ADW 9336 or techus@ad-waters.com

Ce document détaille les conditions de la garantie offerte par FIORA BATH COLLECTIONS, S.L.U., sur les produits qu'elle commercialise, conformément aux conditions indiquées ci-après :

1. La GARANTIE permet à FIORA BATH COLLECTIONS, S.L.U., de réparer ou de remplacer le produit selon la meilleure solution considérée pour le produit défectueux. Cette garantie est appliquée à des produits vendus par un distributeur autorisé sur le territoire des **États-Unis d'Amérique et du Canada**. Les ventes effectuées hors des **États-Unis et du Canada** ne sont pas incluses dans la portée de cette garantie sauf accord exprès de FIORA BATH COLLECTIONS, S.L.U.
2. **Cette garantie ne couvre pas les frais de main d'œuvre et d'envoi, ni les dommages encourus totalement ou partiellement lors de l'installation, du déménagement, de la réinstallation, de la réparation ou du remplacement de tout produit ou de toute pièce de FIORA BATH COLLECTIONS, S.L.U., ainsi que les dommages, pertes et frais directs ou indirects, accidentels ou consécutifs, résultants de toute cause.**
3. **La durée de la garantie est de 5 ans** à partir de la date de facturation ou de la date du reçu de l'achat ou, le cas échéant, de la date de la livraison si celle-ci n'est pas postérieure aux documents mentionnés au préalable. Si le produit était un modèle d'exposition ou de démonstration chez un détaillant, la garantie n'est applicable que pendant un an.
4. FIORA BATH COLLECTIONS, S.L.U. garantit ses produits et composants contre tout défaut de fabrication à condition qu'ils aient été correctement installés (conformément à la réglementation en vigueur et aux instructions indiquées pour leur montage, entretien et conservation) et qu'ils aient été correctement utilisés tel que leur conception le prévoit.
5. Les articles consommables (éléments en caoutchouc, joints, etc.) ne sont pas couverts par cette garantie.
6. La GARANTIE présente **exclut** ce qui suit :
 - a. Dommages résultants du transport.
 - b. Dommages résultants d'une installation incorrecte, d'une manipulation ou de réparations effectuées par un personnel non autorisé par FIORA BATH COLLECTIONS, S.L.U. ; de même que les dommages résultants de l'usure naturelle, du mauvais traitement et de l'utilisation et de l'entretien incorrects, inadéquats, anormaux ou différents d'un usage normal et/ou de ceux indiqués sur les instructions correspondantes.
 - c. Dommages causés par de la saleté, du calcaire et d'autres défauts physiques, chimiques ou électrochimiques.
 - d. **Dommages ou pertes subies par toute catastrophe naturelle comme un feu, un séisme, une inondation, du tonnerre, un orage électrique, etc.**
 - e. Dommages qui, objectivement, ne peuvent pas être attribués au fabricant.
 - f. Dans le cas des bases de douche, veuillez vérifier les dimensions, la couleur, etc. avant de les installer. Aucune réclamation ne sera acceptée pour ces raisons une fois installées.
 - g. Dans le cas des bases de douche, **avant de terminer le carrelage et de placer tout autre élément sur la base de douche, l'installateur est tenu de vérifier l'installation correcte et de s'assurer que la base draine parfaitement.** Si cette vérification ne s'effectue pas correctement, FIORA BATH COLLECTIONS, S.L.U. ne prendra pas en charge les frais résultants du remplacement des éléments placés sur la base tels que les pares-douche ou les céramiques.
7. **Les modifications faites aux bases de douche et aux panneaux de douche: les bases de douche et les panneaux de douche coupés sur place par le client ou l'installateur sont couverts par cette garantie à condition qu'ils suivent et respectent les instructions d'installation de FIORA BATH COLLECTIONS, S.L.U. Veuillez consulter les instructions d'installation de votre base de douche ou de votre panneau afin de connaître les spécifications et les restrictions concernant les coupes sur place. Si les instructions d'installation n'ont pas été suivies, la GARANTIE sera automatiquement annulée.**
8. **Cette garantie s'étend au premier acheteur au commerce de vente au détail et elle n'est pas transmissible. Le reçu d'achat original doit être disponible afin d'exercer la garantie.**
9. Pour toute question ou demande de service de garantie, veuillez prendre contact avec le distributeur nord-américain de FIORA, AD WATERS :

AD WATERS CANADA:

QC et région d'Ottawa: 1 888 ADW 9336 ou tech@ad-waters.com
Ouest du Canada, Ontario et Maritimes: 1 888 ADW 9336 ou techtoronto@ad-waters.com
États-Unis: 1 888 ADW 9336 ou techus@ad-waters.com

FIORA is distributed exclusively in North America by:
FIORA est distribué en Amérique du Nord en exclusivité par:

AD WATERS

www.ad-waters.com

Tel. 1 888 ADW-9336

fiora.us